

USE AND MAINTENANCE

SIAGA
www.siafa.com.ar



CHEMIST 900

SIAGA
www.siafa.com.ar

Industrial Emissions Analyzer

SEITRON S.p.A. a socio unico - ALL RIGHTS RESERVED -

Any reproduction, in whole or in part, of this document by any means (including photocopying or storing it in any electronic device) and the transmission of the latter to third parties in any way, including electronically, is strictly forbidden without the prior written approval by SEITRON S.p.A. a socio unico

IMPORTANT INFORMATION	08
Information about this manual	08
Safety warnings	08
SAFETY	09
Intended use of the product	09
Improper use of the product	09
GENERAL FEATURES	10
Overview of the Flue Gas Analyzer	10
DESCRIPTION OF THE PRODUCT	12
Operating principle	12
Measurement cells	12
Infrared bench	13
CO dilution	13
Types of fuels	13
Sample treatment	13
Peltier module condensation assembly (Cooler)	13
Condensate trap	14
Remote condensate sink	14
External dust filters	14
Infrared bench protection dust filters	14
Air filter	14
Remote air inlet	14
Pressure sensor	14
Gas suction pump	15
Peristaltic pump	15
Draft measurement with automatic sensor zeroing	15
Sooth measurement	15
Temperature measurements	15
Auxiliary measurements	15
Tightness test	15
Bluetooth [®] data link	15
DESCRIPTION OF COMPONENTS	16
Front panel	16
Components outside the unit	19
Access to the internal components	20
Internal components - sensors side	21
Internal components - sample treatment side - case of condensate trap	22
Internal components - sample treatment side - case of Peltier cooler	23
TECHNICAL FEATURES	24
Technical features	24
Measurement and Accuracy Ranges	26
STARTUP	28
Preliminary operations	28
Warnings	28
Power supply of the Analyzer	29
Checking and replacing the batteries	29
Use with external power pack	29
Connection diagram	30
Gas sampling heated line (hose + head with AISI 316L stainless steel internal filter for NO _x - SO _x measurement)	32

Gas sampling probe for industrial engines	33
Probe with heated head for carbon black measuring	33
Combustion air temperature sensor	33
Temperature measurement with Tc-K sensor	34
Auxiliary temperatures measurement sensor	34
Ionization current measuring probe	34
Manometer for draft measurement	34
Pressure test kit	34
Burner pressure verification probe	35
Hose for remote zero air suction	35
POWER ON - OFF	36
Starting the device	36
CONFIGURATION	37
Configuration Menu	37
Configuration→Analysis	38
Configuration→Analysis→Fuel	40
Configuration→Analysis→Condensation	41
Configuration→Analysis→O ₂ reference	42
Configuration→Analysis→NO _x /NO ratio	43
Configuration→Analysis→Measurement units	44
Configuration→Analysis→Measures list	45
Configuration→Analysis→Sample processing	47
Configuration→Analysis→Autozero	48
Configuration→Analysis→Air temperature	49
Configuration→Instrument	50
Configuration→Instrument→Bluetooth®	52
Configuration→Instrument→Time/Date	53
Configuration→Instrument→Brightness	54
Configuration→Instrument→Buzzer	55
Configuration→Instrument→Pumps	56
Configuration→Instrument→Pumps→Suction	57
Configuration→Instrument→Pumps→Peristaltic	58
Configuration→Instrument→Dilutor	59
Configuration→Instrument→Micromanometer	60
Configuration→Instrument→NDIR bench	61
Configuration→Operator	62
Configuration→Alarms	64
Configuration→Information	65
Configuration→Information→Battery	66
Configuration→Information→Sensors	67
Configuration→Information→Info Service	68
Configuration→Information→Reminder	69
Configuration→Information→Probes	70
Configuration→Diagnostic	71
Configuration→Diagnostic→Sensors	72
Configuration→Diagnostic→Pump	73
Configuration→Diagnostic→Pump→Suction	74
Configuration→Diagnostic→Pump→Peristaltic	75
Configuration→Diagnostic→Gas probe	76
Configuration→Diagnostic→On site calibration	77
On site calibration procedure	78
Configuration→Diagnostic→Hardware	85
Configuration→Diagnostic→NDIR bench	86
Configuration→Diagnostic→Sample processing	87

Configuration→Language	88
Configuration→Restore	89
MEMORY	90
Memory Menu	90
Memory arrangement	92
Memory→Save	93
Memory→Average	95
Memory→Select	96
Memory→Memory recall	97
Memory→Data logger	100
Memory→Data logger→Manual	101
Memory→Data logger→UNI10389 - BImSchV - data logger	102
Memory→Data logger→Data logger	103
Memory→Delete	105
Memory→Delete→Single	106
Memory→Delete→All	107
Memory→Usage	108
PRINT	109
Print Menu	109
Print→Report	110
Print→Configuration	111
Print→Test	112
Print→Printer	113
Print→Printer→Pairing	114
Print→Header	116
Print→Measures list	118
MEASUREMENTS	120
Measurements menu	120
Measurements→Draft	122
Measurements→Smoke	123
Smoke measurement with manual pump (optional)	124
Performance test with the manual soot pump	124
Smoke measurement with heated head probe (optional)	126
Put into service of the smoke probe with heated head	126
Connecting the heated head probe for smoke measurement	127
Performing the test with the smoke probe	128
Measurements→Ambient CO	129
Measurements→Temperature	130
Measurements→Pressure	131
Measurements→Tightness test	132
Connecting the tightness test kit tool	133
Measurements→Tightness test→New System (UNI 7129)	134
Configuration of tightness test according to UNI 7129	137
Performing the tightness test according to UNI 7129	141
Measurements→Tightness test→Existing System (UNI 11137)	143
Configuration of tightness test according to UNI 11137	146
Performing the tightness test according to UNI 11137	151
Measurements→Tightness test→TRGI	153
Performing tightness test for a gas line up to 100 liter	155
Performing tightness test for a gas line up to 100 / 200 liter	157
Performing tightness test for a gas line with volume greater 200 liter	159
Measurements→Tightness test→Header	161

Measurements→Tightness test→Results of the tightness test	163
Measurements→AUX measurements	164
Measurements→Velocity	165
How to connect the Pitot tube to the instrument	166
Test execution	167
Measurements→Power of burner	168
Testing in 'Manual' mode	169
Testing in 'Measure' mode (based on flow rate)	170
Testing in 'Measure' mode (based on meter)	171
Measurements→Ionization probe	173
COMBUSTION ANALYSIS	174
Combustion Analysis	174
Startup and device auto-calibration	174
Inserting the probe in the stack	174
Simultaneous measurement of pressure, O ₂ , pollutants	175
Combustion Analysis	176
End of Analysis	176
Combustion Analysis - Preliminary operations	177
Combustion Analysis - Manual mode	179
Combustion Analysis - UNI 10389 mode	181
Combustion Analysis - BImSchV mode	183
Combustion Analysis - Data logger mode	184
Combustion Analysis - Periodic mode	186
SENSORS	187
Sensors arrangement in the sensors compartment	187
Sensors list	187
Sensor types and relevant positioning	188
Gas sensors life	189
Gas sensors life table	189
Expandability to 9 sensors	190
CxHy sensor for measurement of the unburnt hydrocarbons (Pellistor)	191
Installing the CxHy sensor	191
CO ₂ sensor for Carbon Dioxide measurement (NDIR single sensor)	192
Installing the CO ₂ sensor	192
NH ₃ sensor for ammonia gas measurement in combustion processes	193
NDIR infrared bench	194
MAINTENANCE	195
Routine maintenance	195
Preventive maintenance	195
Cleaning the sample probe	195
Cleaning the industrial engines sample probe	196
Cleaning the heated sample probe	197
Maintaining the external dust filter unit	198
Replacing the gas sensors	199
Replacing the printer paper roll	202
Firmware update	203
TROUBLESHOOTING	204
Troubleshooting guide	204

TABLE OF CONTENTS

SPARE PARTS AND SERVICE	206
Spare parts	206
Accessories	207
Service centers	208
ANNEX A - Analysis report examples	209
ANNEX B - Coefficients of the fuels and Formulas	212
ANNEX C - Normative references	213
ANNEX D - Optional measures list	216
WARRANTY CERTIFICATE	219



WARNING

This manual is referred to firmware version 1.26.
Visit our website www.seitron.com to download the latest User and Maintenance manual.



1.1 Information about this manual

- This manual describes the operation and the characteristics and the maintenance of the Combustion Analyzer Chemist 900.
- Read this operation and maintenance manual before using the device. The operator must be familiar with the manual and follow the instructions carefully.
- This use and maintenance manual is *subject to change due to technical improvements - the manufacturer assumes no responsibility for any mistakes or misprints.*



Respect your environment: think before printing the full manual on paper.

1.2 Danger levels and other symbols

Symbol	Meaning	Comments
	Warning	<p>Read information carefully and prepare safety appropriate action!</p> <p>To prevent any danger from personnel or other goods. Disobey of this manual may cause danger to personnel, the plant or the environment and may lead to liability loss.</p>
	Information on LCD	
	Ensure correct disposal	<p>Dispose of the battery pack at the end of its working life only at the dedicated collecting bin.</p> <p>The customer takes care, on his own costs, that at the end of its working life the product is collected separately and it gets correctly recycled.</p>
	Keyboard with preformed keys with main control functions.	

2.1 Proper use of the product

This chapter describes the areas of application for which this instrument is intended.

All products of the series CHEMIST 900 are portable measuring devices for flue gas and emissions analysis for the following machinery:

- Furnaces (fuel oil, gas, wood, coal)
- Low-temperature and condensing boilers
- Gas heaters
- Combustion in industrial processes
- Measures for control of emissions
- Machinery test compliance
- Gas turbines
- Gas engines
- Furnaces and boilers manufacturer's technical assistance
- Technical assistance in industrial heating systems

This measuring device is capable of measurements under German regulations on emissions protection (1. BImSchV)¹.

Additional functions of this measuring instrument:

- Flue gas analysis according to 1. BImSchV or qA-a mean value (selectable)
- Calculating of stack heat loss and efficiency
- CO environment measurement
- Tightness test of gas tubes under standards UNI 7129-1: 2015 and UNI 11137: 2019
- Smoke value, calculation of average value
- Measurement of differential pressure
- Draft measurement
- Pressure measurement in the gas supply line

2.2 Improper use of the product

The use of CHEMIST 900 in application areas other than those specified in Section 2.1 "Intended use of the product" is to be considered at the operator's risk and the manufacturer assumes no responsibility for the loss damage or costs that may result. It is compulsory to read and pay attention to the instructions in this use and maintenance manual.

CHEMIST 900 should not be used:

- as an alarm device for safety purposes
- in classified zones with explosion risk (ATEX or equivalent)

3.1 General overview of the Analyzer

CHEMIST 900 is a portable industrial analyzer for flue gas and emissions monitoring.

The instrument is equipped with:

- Pneumatic circuit which can accommodate up to 9 sensors in the FLEX-sensors series.
- Housing for fitting an NDIR (infrared) bench for measurement of CO, CO₂ and CH₄.

Moreover:

- The gas autozero cycle can be performed with the probe inserted in the chimney.
- The autozero of the pressure sensor (piezoresistive, temperature compensated) can also be performed with the gas probe inserted in the chimney.
- Intuitive user interface: the instrument can be used without the support of the user manual.
- Wide (55x95 mm) and bright TFT color display which delivers great readability thanks to the zoom function and an efficient backlight.
- Single rechargeable 'Li-Ion' battery pack, used to power both the unit and the thermal printer. The battery charger is internal to the instrument and allows to perform the dual function of battery charging and power supply for the instrument, thus enabling the user to work even with the batteries fully discharged by connecting the AC power cable, once connected to a 90 to 264Vac mains source.
- Thermal printer integrated in the instrument.
- Connectivity with a computer through the USB connection and/or Bluetooth®. Once the special software provided with the instrument is used, this allows for the storage of combustion analysis as well as the configuration of the main parameters.
- Connectivity with a smartphone through Bluetooth®. Once the specific APP 'SEITRON SMART ANALYSIS' available on Google play-store is installed on the device, the user can start remote analysis of combustion and/or view real-time data of the analysis in progress.

CHEMIST 900 Analyzer is transportable and therefore is delivered in a durable aluminum case.

Main functions:

- Combustion analysis in manual or automatic mode (UNI 10389-1 or BlmSchV or according to the data logger function, user-defined mode).
- Comes with 11 most used fuel parameters (such as natural gas, LPG, gas oil and fuel oil).
- Possibility to store in memory the parameters for 16 further fuels, once their chemical composition is known.
- Monitoring of pollutants (emissions)
- Memory capable of storing up to 16,000 full analysis.
- Storing of acquired data and their averaging.

Measurable gases:

- CO (NDIR), CO₂ (NDIR), C_xH_y (NDIR)
- O₂
- CO (ambient monitoring)
- CO / H₂
- CO (low, medium, high)
- NO (low, medium)
- NO₂ (low, medium)
- SO₂ (low, medium)
- NO_x
- H₂S
- NH₃
- H₂

Measurements:

- Ambient CO (with the internal sensor)
- Draft in the chimney.
- Smoke (with the use of the external manual pump).
- Gas pressure in the piping, pressure in the burning chamber and check of the pressure switches, using the measurement range up to 200hPa.
- Combustion air measurement
- Auxiliary temperatures
- Tightness test according to UNI 7129-1: 2015 and UNI 11137: 2019
- Air speed for air or flue gas leaving the chimney with the use of Pitot tube
- Ionization current measurement (with external auxiliary probe)

Maintenance:

- Sensors can be replaced by the user without having to ship the instrument to the service center, because the spare sensors delivered are pre-calibrated.
- The instrument requires annual calibration, as required by the standard UNI 10389-1, carried out at any authorized service center.

Certificate of calibration

The instrument is accompanied with a calibration certificate.

4.0 DESCRIPTION OF THE PRODUCT

4.1 Working principle

The gas sample is taken in through the gas probe, by a diaphragm suction pump inside the instrument. The measuring probe has a sliding cone that allows the probe to be inserted in holes with a diameter of 11 mm to 16 mm and to adjust the immersion depth: **it is recommended to have a gas sampling point roughly in the center of the flue/stack.** The gas sample is cleaned of humidity and impurities by a condensate trap and filter located inside the instrument. The gas is then analyzed in its components by electrochemical and infrared sensors. The electrochemical cell guarantees high precision results in a time interval of up to about 60 minutes during which the instrument can be considered very stable. When measurement is going to take a long time, we suggest auto-zeroing the instrument again and flushing the inside of the pneumatic circuit for three minutes with clean air. During the zero calibrating phase, the instrument aspirates clean air from the environment and detects the cells' drifts from zero (20.95% for the O₂ cell), then compares them with the programmed values and compensates them. The pressure sensor autozero must, in all cases, be done manually prior to measuring pressure. The values measured and calculated by the microprocessor are viewed on the LCD display which is backlit to ensure easy reading even when lighting is poor.

4.2 Measurement cells

The instrument takes advantage of pre-calibrated FLEX-series gas sensors for the measurement of Oxygen (O₂), Carbon Monoxide (CO - Hydrogen compensated measurement, Nitrogen Oxide (NO), Nitrogen Dioxide (NO₂), Sulphur Dioxide (SO₂) and Hydrogen sulfide (H₂S). The sensors do not need particular maintenance yet they have to be replaced periodically when exhausted. Measurement of the oxygen (%O₂) is carried out with an electrochemical cell that behaves like a battery which it is subject, over time, to lose sensitivity due to the fact that normally is ever present in the air about 20.9% Oxygen. The toxic gases (CO, SO₂, NO, NO₂) are measured with electrochemical sensors that are not subject to natural deterioration being intrinsically lacking of oxidation processes. The measurement cells are electrochemical cells made up of an anode, a cathode, and an electrolytic solution, which depends on the type of gas to be analyzed. The gas penetrates the cell through a selective diffusion membrane and generates an electric current proportional to the absorbed gas. Such current is measured, digitalized, temperature-compensated, processed by the microprocessor, and displayed.

The gas shall not be at such a pressure to damage or destroy the sensors; for this reason the suction pump is continuously adjusted, in order to ensure an appropriate flow to the sensors. The maximum estimated allowed pressure is $\pm 100\text{hPa}$ gage.

The response times of the measurement cells used in the analyzer are:

O ₂	=	20 sec. at 90% of the measured value
CO(H ₂)	=	50 sec. at 90% of the measured value
CO	=	50 sec. at 90% of the measured value
NO	=	40 sec. at 90% of the measured value
NO ₂	=	50 sec. at 90% of the measured value
SO ₂	=	50 sec. at 90% of the measured value
H ₂ S	=	50 sec. at 90% of the measured value
NH ₃	=	90 sec. at 90% of the measured value
H ₂	=	90 sec. at 90% of the measured value

It is therefore suggested to wait 5 minutes (anyway not less than 3 minutes) in order to get reliable analysis data.

If sensors of toxic gases are submitted to concentrations higher than 50% of their measurement range for more than 10 minutes continuously, they can show up to $\pm 2\%$ drift as well as a longer time to return to zero. In this case, before turning off the analyzer, it is advisable to wait for the measured value be lower than 20ppm by in taking clean air. If there is an automatic calibration solenoid, the device performs an automatic cleaning cycle and it turns off when the sensors return to a value close to zero. The auto-zero solenoid valve allows the operator to turn the instrument on with the probe inserted in the flue. Up to 4 alarm set points are programmable with visual and acoustic signals for the relevant measurement parameters. The UNI 10389-1 standard provides that the instrument must be calibrated by a certified laboratory that is authorized to issue annual calibration certificates. Exhausted cells can be easily replaced by the user without depriving himself of the instrument and without complicated calibration procedures with certified mixtures as they are pre-calibrated before being supplied. Seitron certifies the accuracy of the measurements only upon a calibration certificate issued by its laboratory or other approved laboratory.



WARNING

Some sensors (for example NH₃, H₂, H₂S, SO₂,...) are sensible to other gases called interfering gases.

On the analysis phase, the influence of interfering gases is compensated only if on the instrument are installed the correspondent sensors.

If a sensor sensitive to NO and NO₂ interfering gases is installed on the instrument, but only the NO sensor is installed in the instrument, NO₂ gas compensation is carried out starting from the NOx/NO ratio.

4.3 Infrared bench - Optional

On this instrument it is possible to install an infrared bench, for the measurement of gases, which is based on the infrared spectroscopy (IR). With this method it is possible to measure CO, CO₂ (which are therefore not calculated, but measured instead), and hydrocarbons C_xH_y. Along the pneumatic circuit, before the IR bench, an additional dust filter is inserted.

The principle is based on non-dispersive absorption of infrared radiation (NDIR) at two different wavelengths, which allows accuracy, stability over time and high response speed.

The gases absorb light at particular wavelengths, most in the IR range. An NDIR system includes: an IR light source, a chamber containing the gas sample to be analyzed, and a photodetector equipped with an optical filter. The light passes through the chamber and the sample of the gas will absorb it at a specific wavelength (eg. 4.26µm for CO₂) or on specific bands.

The signal collected by the photodetector is then processed by the electronics in order to obtain the concentration of CO, CO₂ or C_xH_y.

The filter is the non-dispersive optical component and allows the photodetector to uniquely identify the gas based on the performance of the absorption spectrum. The more narrow the bandwidth of the filter, the greater the specificity of the sensor.

The intensity of light (at a certain wavelength) that reaches the detector is inversely proportional to the concentration of the gas treated. The infrared measurement technique allows measurements that are not interfered by the presence of other gases.

4.4 CO dilution

One of the characteristics of the electrochemical sensor for the measurement of CO is the need to require very long self-calibration time in case it has been in contact with high gas concentration (greater than the full scale) for a long time.

The CO sensor is therefore protected in this instrument by an automatic dilution system that allows to extend the measuring range of the sensor without overloading the sensor itself.

The dilution system allows to have the CO sensor efficient any time and ready to perform properly even in case of very high concentration of CO.

The dilution system also allows to extend the measurement range of the CO sensor as follows:

- up to 100,000 ppm for a CO sensor with 8000 ppm full scale
- up to 250,000 ppm for a CO sensor with 20,000 ppm full scale

In this way in addition to better manage the wearing of the sensor, it is also possible to continue sampling, without any work interruption.

4.5 Fuel types

The device is provided with the technical data of the most common types of fuels stored in its memory. By using the PC configuration program, available as an optional, it is possible to add fuels and their coefficients in order to define up to a maximum of 32 fuels, other than the default ones.

For more details see [Annex B](#).

4.6 Sample treatment

The gas sample to be analyzed must be delivered to the measuring sensors properly dried and cleaned of solid residues of combustion; actually for this reason it is usually named 'dry analysis'.

For this purpose CHEMIST 900 accepts two different modules for sample treatment:

- Peltier module condensation assembly (Cooler)
- Water trap

4.6.1 Peltier module condensation assembly (Cooler) - Option

This is an integrated system for the conditioning of the gas sample.

The condensation assembly with Peltier module has the goal of cooling as fast as possible the gas sample down to the temperature of 5° C.

The cooler causes the moisture contained in the gas to condensate thus allowing the gas to reach the sensors without undergoing significant changes in its composition. This system is particularly useful when water-soluble components have to be analyzed (eg. SO₂, NO₂, etc.).

In order to raise the efficiency of the Peltier module condensation assembly, it is advisable to use, for the sampling of gas, a special probe with heated head and/or heated hose.

This probe includes in its interior a thermoresistance for the automatic control of the temperature, which must be maintained above the dew point any time, to prevent unwanted condensation at the probe level.

The heated hose allows the gas to reach Peltier module condensation assembly unchanged in its chemical characteristics.

In conditions of extreme ambient temperature (+45° C) it is possible that the internal temperature of the cooler is not maintained at +5° C but tends to move up to +10° C /+15° C, this internal temperature is still sufficient to obtain the drying of the gas, in these conditions it is possible to lose about a 10% efficiency of drying.

4.6.2 Water trap - Optional

Consisting of a cylinder in transparent polycarbonate it is positioned along the pneumatic circuit inside the body of the analyzer.

Its purpose is to decrease the speed of the air so that it will be no longer able to carry the heavy particles of dust and water which, consequently, will fall into the cylinder.

The bottom of the water trap's body is connected to a peristaltic pump, controlled directly by the microprocessor, for the emptying thereof. The condensation water is expelled through the condensation drain positioned at the bottom of the analyzer. The peristaltic pump is activated in an intermittent manner in order to preserve the life of the hose, which is an integral part of the pump itself.

The hose has an average life of about 500 hours; the diagnosis menu features a timer which countdowns the residual life of the hose. When the hose is replaced, it is mandatory to manually reset the timer [see section 9.9.2](#)).

4.7 Remote condensate drain

On the bottom side of the instrument suitcase is located the output of the condensation water.

By properly connecting an appropriate silicone hose it is possible to move the output point of the condensation water.

4.8 External dust filters

In order to protect the pneumatic circuit and the gas sensors, two protecting filters are placed inside the analyzer. These two filters are in series with each other: the first is the lowest one, the second is at the top.

Consisting of a cylinder in transparent polycarbonate, these are located on the left side of the analyzer protected from impacts with a protection bar.

A replaceable, low-porosity filter is positioned within each cylinder with the purpose of retaining solid particles suspended in the flue gas. The filter has an efficiency of 99% for 20um solid particles.

It is recommended to replace the filters any time they are significantly dirty (see section ['MAINTENANCE'](#)).

4.9 Dust filter for the NDIR bench protection

For further protection of the NDIR bench, an additional dust filter has been inserted into the analyzer. Located aside of the cells, it is made of a cylinder in transparent polycarbonate with a replaceable, low-porosity filter inside, with the purpose of retaining solid particles suspended in the flue gas. We recommend to check the filter once a year during periodic maintenance.

4.10 Air filter

A further dust filter is located inside the analyzer with the purpose to protect the circuit that samples air from the environment during the autozero cycle. We recommend to check the filter once a year during periodic maintenance.

4.11 Remote air intake

The top panel of the analyzer is a pneumatic connector labelled as 'ZERO CAL'. This connector is the air intake used to perform the auto-zero for the gas sensors.

In particular conditions, where the instrument is placed in a closed and potentially polluted environment, it is possible to move the air intake of the instrument to an environment with clean air, through the use of a hose with an appropriate male fitting connected to the 'ZERO CAL' input.

4.12 Pressure sensor, piezoelectric, temperature compensated

The instrument is internally provided with a piezoresistive differential pressure sensor, temperature compensated, for measuring pressure or draft.

This sensor is differential type thus, thanks to the second measurement port, can be used for measuring the draft (depressure) in the chimney, for the leak test of the pipes, for differential pressure measurement, for measuring the velocity of the flue gas using a Pitot tube, for flow measurement, and possibly for other measurements (pressure of gas in the piping, pressure loss across a filter, etc.).

The measurement range is -1,000 Pa .. +20,000 Pa.

Any potential drift of the sensor are nulled thanks to the autozeroing system which in this instrument can be operated with the flue gas probe inserted in the chimney, because the instrument is equipped with an electrovalve that switches the pressure measurement to the ambient, thus allowing to zero the sensor in air.

4.13 Suction pump

This diaphragm pump, located inside the instrument, is operated with a DC engine powered by the instrument in order to obtain the optimal suction flow rate of the flue gas for the ongoing analysis; an internal sensor measuring the flow allows to:

- Maintain a constant flow rate of the pump
- Check the state of efficiency of the pump
- Check the level of filter clogging



WARNING

ANY PRESSURE APPLIED TO THE SENSOR GREATER THAN ± 300 hPa MAY CAUSE A PERMANENT DEFORMATION OF THE MEMBRANE, THUS DAMAGING IRREVERSIBLY THE SENSOR ITSELF.

4.14 Simultaneous measurement of pressures, O₂, pollutants

The instrument, in order to obtain the best boiler's combustion performance parameters, allows to measure simultaneously the input and output pressure of the gas valve, the level of O₂, the levels of pollutants and all the calculated parameters needed to obtain the correct value of yield.

[See section 13.1.3.](#)

4.15 Peristaltic pump

The peristaltic pump has the purpose to automatically empty the condensation water and it is controlled directly by the microcontroller with alternating intervals of on/off in order to preserve the life of the neoprene hose.

While the interval of ignition is not user controllable, and it is equal to 30 seconds, the duration of the interval is configurable by the user in the range 30..3600 seconds.

4.16 Draft measurement with sensor automatic autozero

CHEMIST 900 performs the draft pressure measurement. The auto-calibration of the sensor is carried out through the switching of an internal valve that allows to perform the zeroing procedure without removing the probe from the chimney.

This feature is particularly useful when the analysis is taken in 'data logger' mode.

4.17 Smoke measurement

It is possible to enter the smoke values measured according to the smoke index scale. The instrument will calculate the average and print the results in the analysis report.

The measurement must be performed with the appropriate probe head heated to measure the carbon black or an external pump which may be required as an accessory .

4.18 Temperature measurements

CHEMIST 900 can measure several types of temperatures taking advantage of dedicated probes.

4.19 Auxiliary measurements

This analyzer also features a connection to optional external sensors for draft measurement according to the UNI10845 standard as well as for the measurement of the ionization current in the boilers.

4.20 Tightness test

The instrument can perform the tightness test of a piping according to the Italian standards UNI 7129-1: 2015 and UNI 11137: 2019.

4.21 Bluetooth® connection

The CHEMIST 900 analyzer is internally equipped with a Bluetooth® module, which allows the communication with the following remote devices:

- Remote Bluetooth® printer
- Smartphone or tablet with installed the OS Google Android v.4.1 (Jelly Bean) or later and the proper APP 'Seitron Smart Analysis' (available on Google Play Store) installed.
- PCs running Microsoft Windows 7 or later and Bluetooth® interface upon installation of the specific software 'Seitron smart analysis' supplied together with the instrument.

The maximum transmission range in open field is 100 meters (Class 1 Bluetooth® module), provided that also the communication companion is equipped with a Class1 Bluetooth® interface.

This solution allows greater freedom of movement for the operator who is no longer bound directly to the instrument for acquisition and analysis, with significant advantages for many applications.





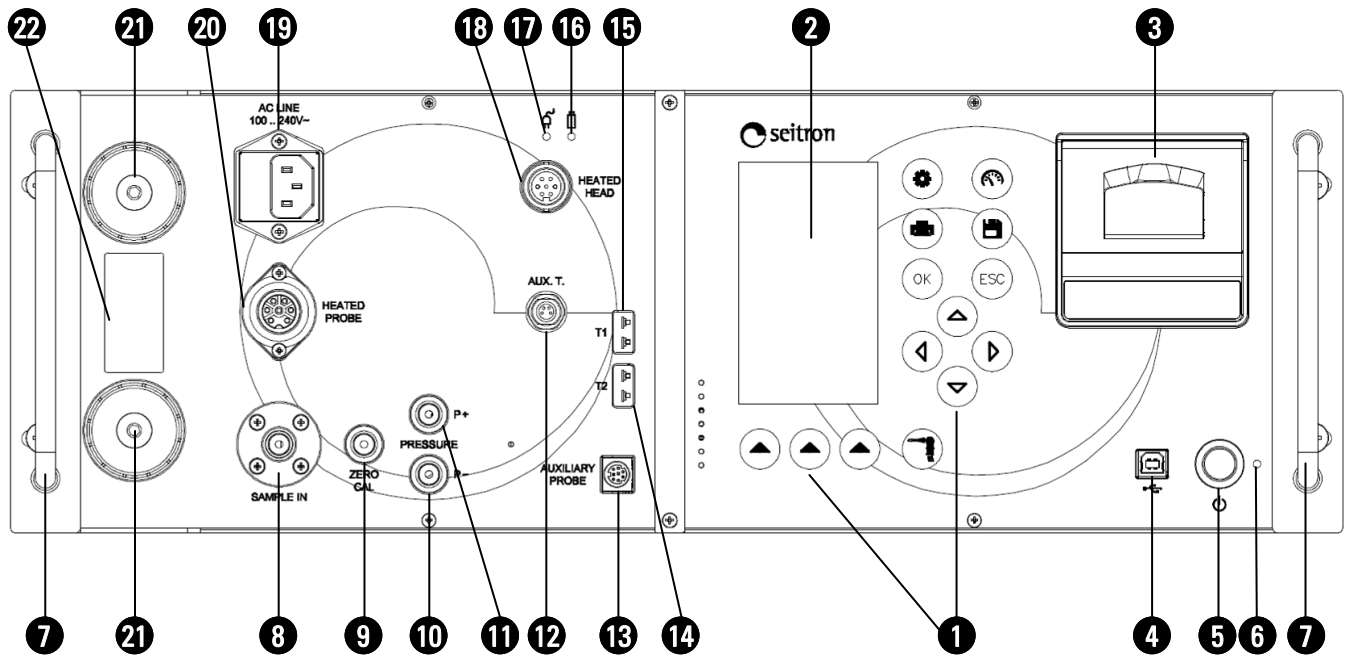

5.0 DESCRIPTION OF COMPONENTS





5.1 Front panel



DESCRIPTION:

1 Polycarbonate touch keypad and relevant main functions:

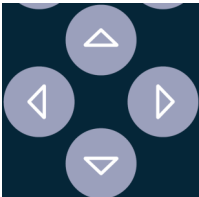
KEY	FUNCTION
	Activates the context keys shown on the display
	Performs the combustion analysis
	Access to the Configuration menu
	Access to the Measurements menu
	Access to the Printing menu
	Access to the Memory menu

KEY	FUNCTION
	Confirm settings
	Quits the current screen
	Select and/or Modify
	Turns off the display backlight

2 Display



TFT 272 x 480 pixel backlit color display with 21 characters available and 8 lines. Allows the user to view the measured parameters in the most comfortable format; a Zoom function displays the measured values in magnified form.

CAUTION:

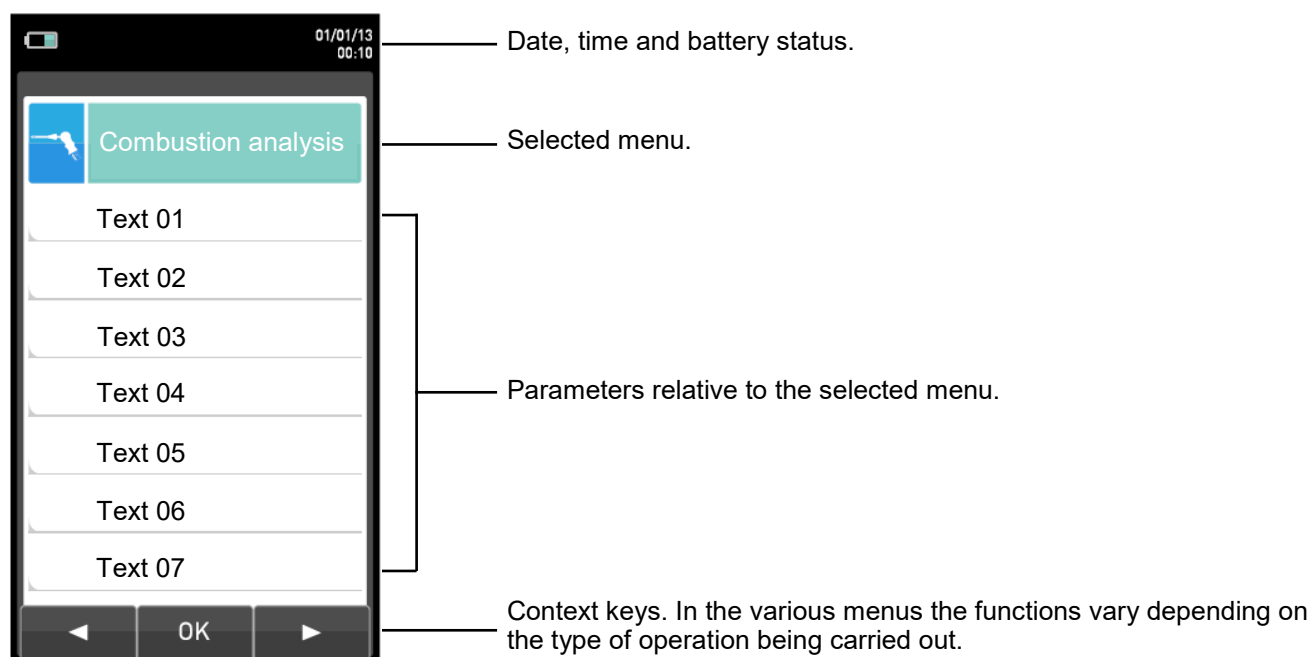
If the instrument is exposed to extremely high or extremely low temperatures, the quality of the display may be temporarily impaired. Display appearance may be improved by acting on the contrast key.



Backlight:

The backlight can be turned off with the simultaneous pressure on keys  + .

The backlight is turned on when any key is pressed, except the 'On-Off' key.

3 Printer

Thermal printer on non-fading paper.

By pressing the print button you get access to the corresponding menu from which, in addition to printing the receipt, you can choose the print settings and manually feed the paper in order to simplify the replacement of the paper roll.

4 USB connector (type B)

Used to connect the instrument to a personal computer running Microsoft Windows 7 or later upon installation of the specific software 'Seitron smart analysis', supplied with the instrument.

5 ON / OFF key

To turn on or off the analyzer hold this key down for a few seconds.

6 Programming LED

This LED provides important information during the firmware update procedure. For further details please refer to [section 15.9 'Firmware Update'](#).

7 Handles for the extraction of the instrument from its case

8 'SAMPLE IN' pneumatic connector

Input for connecting the gas sample probe.

9 'ZERO CAL' pneumatic connector

Input for the connection of a hose to remote air source to properly perform the autozero. If the instrument is placed in a closed and potentially polluted environment, the user can remote the air intake for the instrument to a clean air environment using the 'ZERO CAL' connector.

- 10 'P-' pneumatic connector**
Pressure negative input (P-): used for measuring draft according to the standard UNI10845; it connects to the second hose (with the larger pneumatic connector) of the sample probe for simultaneous measurement of draft and combustion analysis.
- 11 'P+' pneumatic connector**
Positive input (P+): used for measuring the pressure in general as well as for the leakage test.



Inputs 'P+' and 'P-' are respectively the positive and negative inputs of the internal differential pressure sensor, piezoresistive, temperature compensated; therefore these can be simultaneously used to measure the differential pressure.

- 12 'AUX. T.' Auxiliary Temperature Connector**
M8 4-pole connector for an external temperature sensor (Pt100).
- 13 'AUXILIARY PROBE' connector**
Serial connector, Mini Din 8-pin, for connection of an external probe such as:
- Probe for measurement of the ionization current
- Micromanometer
- 14 'T2' Connector**
Used to connect the Tc-K plug of the incoming combustion air temperature probe.
- 15 'T1' Connector**
Used to connect the Tc-K male connector of the gas temperature probe.
- 16 Battery-charging indicator**
This LED, while the batteries are charging, provides the following information:
On (red): Battery charging
Off: Fully charged batteries
Once recharging is started the display is turned on and shows the charging status.
- 17 Mains power indicator**
On (green): The instrument is powered directly from the mains.
Off: The instrument is not powered from the mains.
- 18 'HEATED HEAD' connector**
7-pin DIN connector used to power the heated head.
- 19 'AC LINE - 100..240V ~' connector**
IEC C14 socket for the power cable, supplied with the instrument. On the socket is located a fuse-holder drawer for 2 5x20 4A T type fuses .
- 20 'HEATED PROBE' connector**
Used to connect the relevant connector of the heated probe thus powering the heated hose.
- 21 Two external dust filters**
- 22 Instrument data label**

5.2 Parts external to the instrument

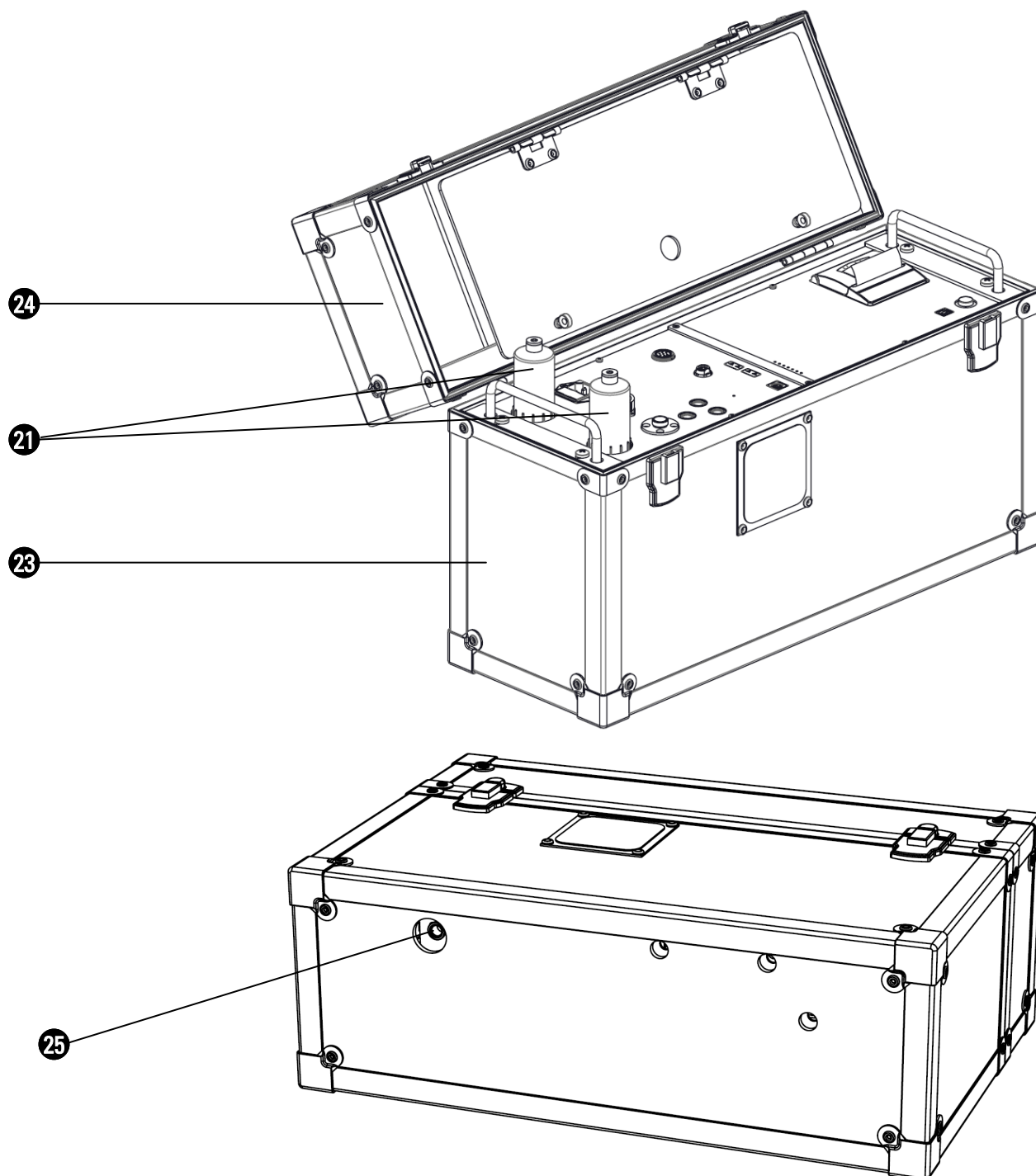

DESCRIPTION:

- 21 Two external dust filters
- 23 Case
- 24 Case - accessories compartment
- 25 Condensate drain

5.3 Access to internal parts

To access the internal parts of the analyzer the instrument has to be removed from the case, as shown in the following pictures:

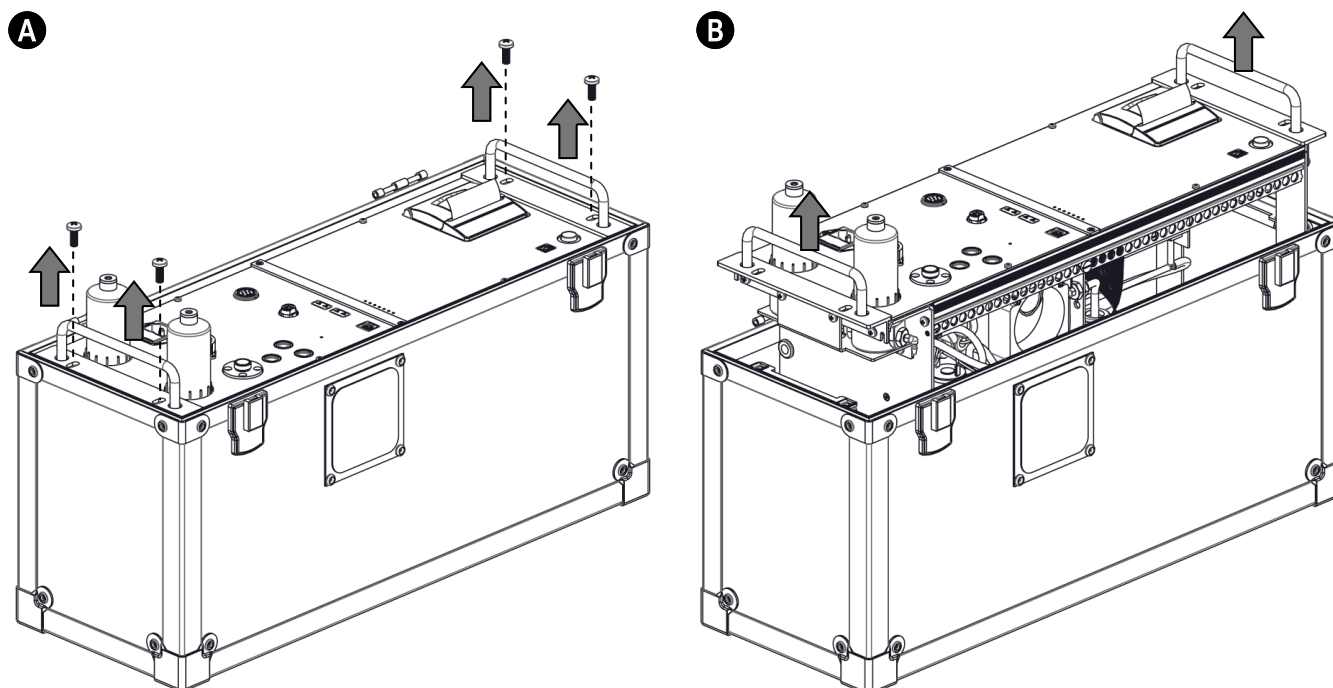

5.4 Instrument internal parts - sensors side

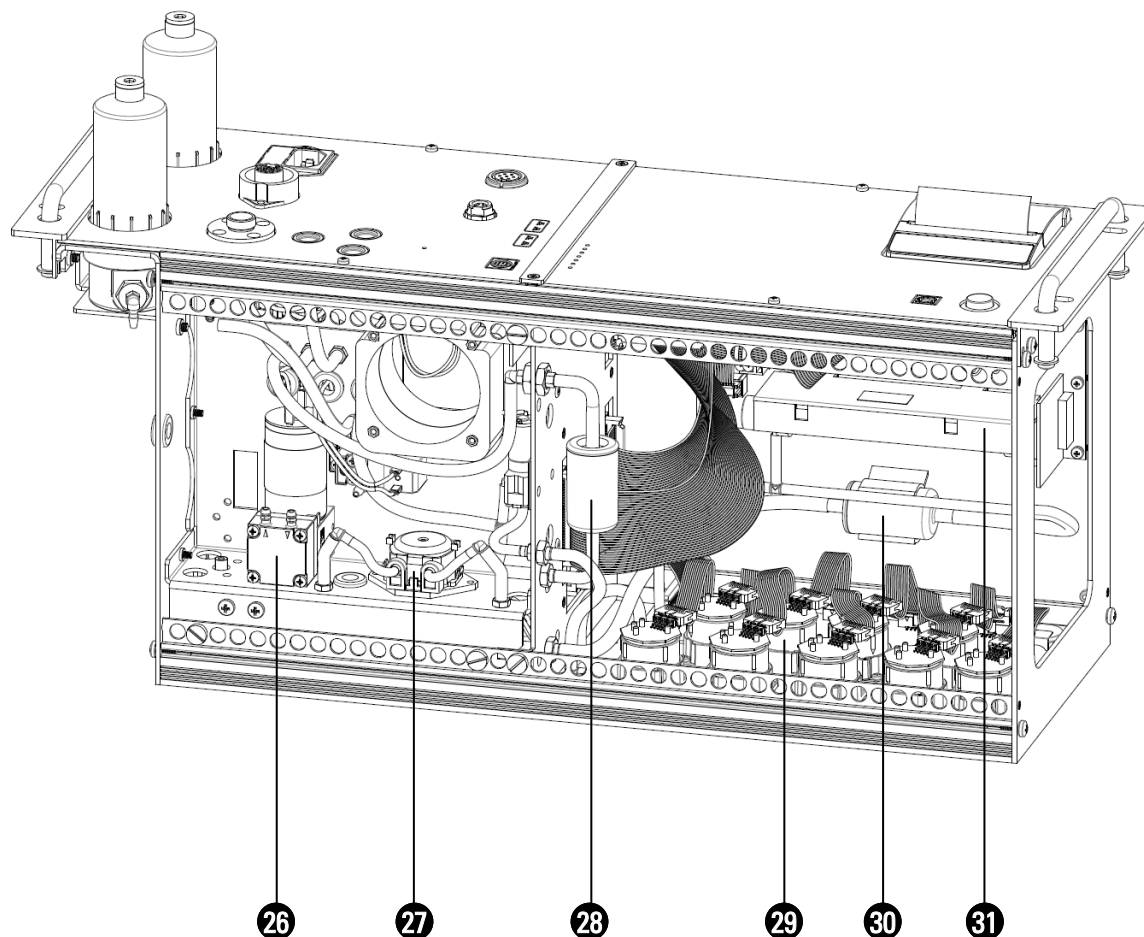

DESCRIPTION:

- 26** Gas suction pump
- 27** Peristaltic pump
- 28** Air filter
- 29** Sensors manifold
- 30** Dust filter for NDIR (infrared) bench protection
- 31** NDIR (infrared) bench

5.5 Instrument internal parts - sample treatment side and condensate trap

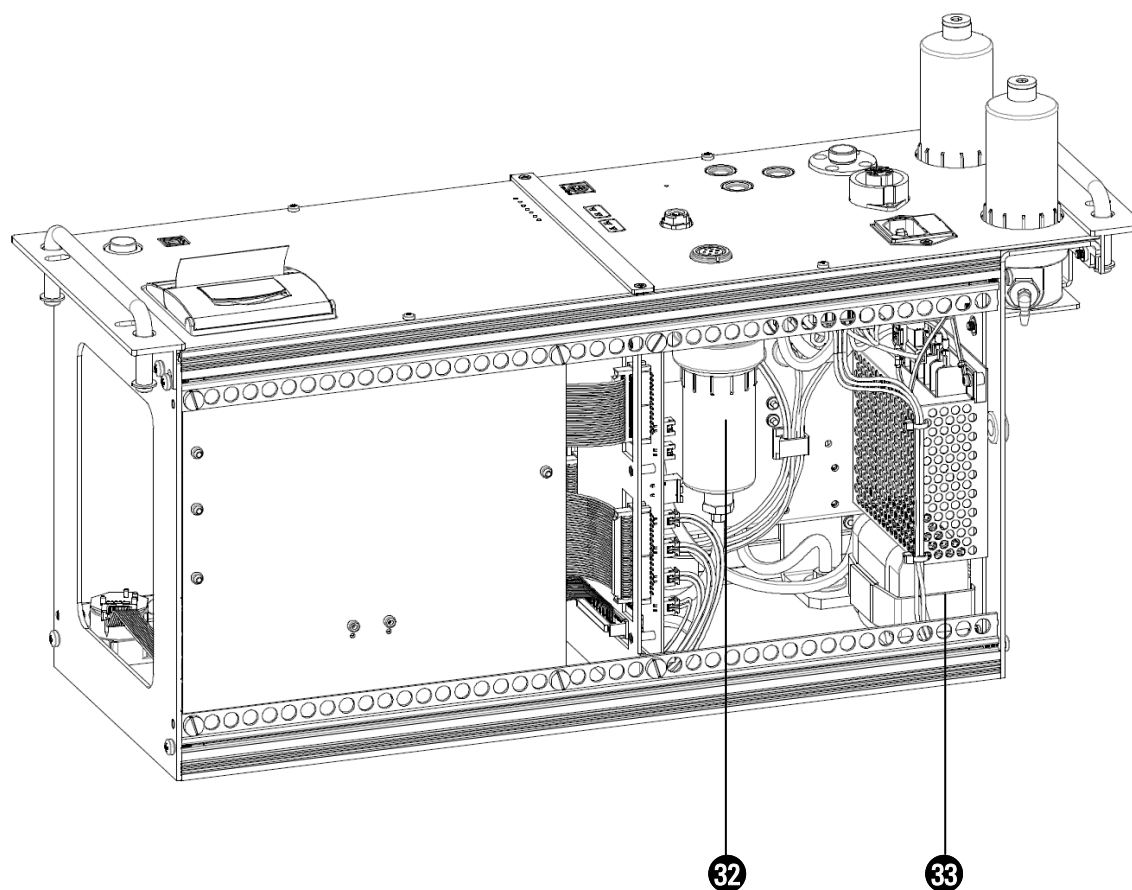

DESCRIPTION:

32 Condensate trap

33 Battery pack

Instrument internal parts - sample treatment side and Peltier module cooler

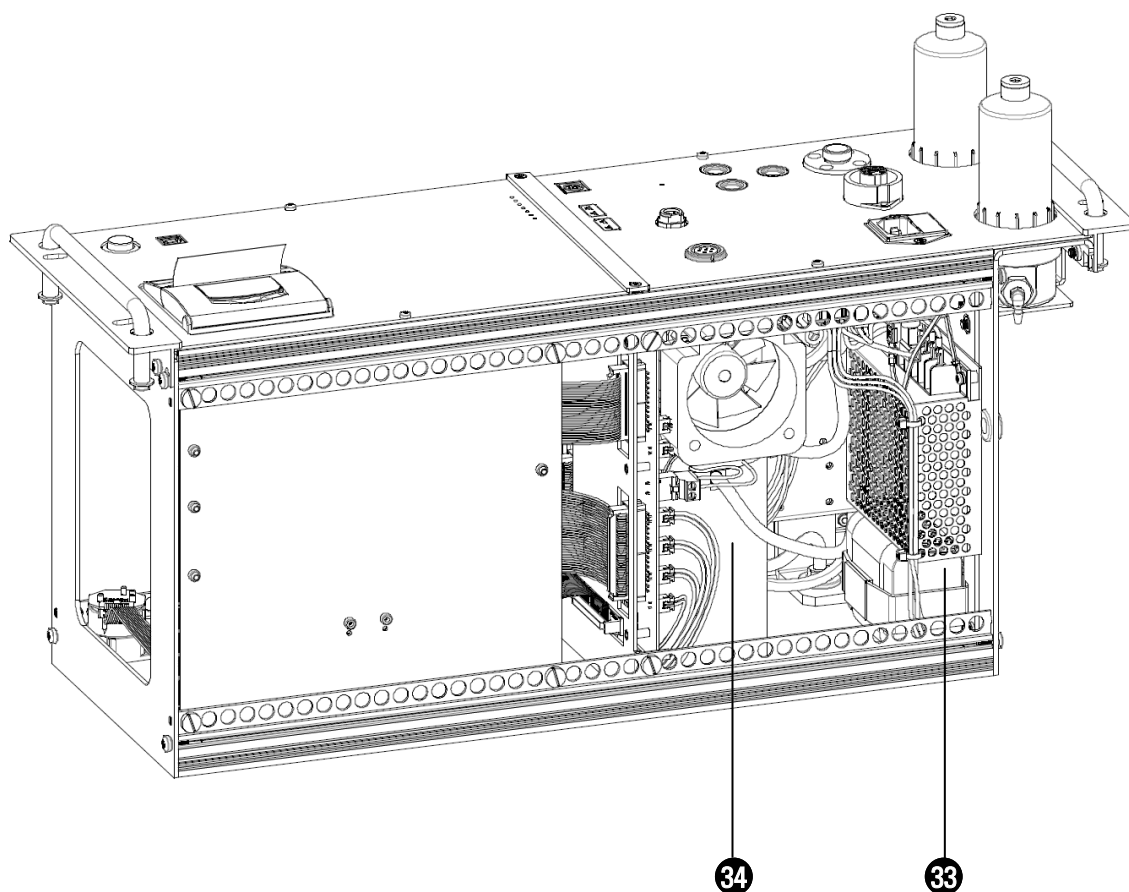

DESCRIPTION:

- 34** Condensing assembly with Peltier module (Cooler)
- 33** Battery pack

6.0 TECHNICAL FEATURES

6.1 Technical features

Power supply:	90 .. 264Vac or Li-Ion battery pack with internal protection circuit, rechargeable.
Battery charger:	With power cable with IEC C14 socket.
Charging time:	8 hours for charging from 0% to 90%
Instrument operating time:	10 hours of continuous operation (without printing and Peltier module cooling assembly operation). 2 hours with cooler active.
Display:	4.3" TFT 272x480 pixels graphic color with backlight
<u>Connectivity:</u>	
Communication port:	USB connector type B.
Bluetooth®:	Class 1. Communication distance <100 meters (in open field)
Autozero:	Automatic autozero cycle with the probe inserted in the chimney.
Dilution:	Widens the CO sensor measurement range up to 100,000ppm (10.00%). Programmable as simple protection of the CO sensor with the intervention level set by the user.
Gas measurement sensors:	Up to 9 configurable sensors: electrochemical, NDIR (single cell) and pellistor.
Infrared bench:	NDIR bench for 3-gases: CO, CO2, CxHy.
Programmed fuels:	15 factory pre-set plus 32 user-programmable.
Self-diagnosis:	Checks all functions and internal sensors and reports any abnormal operation.
Temperature measurement:	Two K-type thermocouple inputs with mini connector (ASTM E 1684-96) for differential temperature measurement (supply and return).
Room temperature measurement:	With internal sensor or through T2 thermocouple input and remote sensor.
Printer:	Integral thermal printer with 'easy loading paper' system and paper presence sensor.
Printer power supply:	With the analyzer batteries.
Printer autonomy:	Up to 40 reports with fully charged batteries.
Internal data memory:	16,000 complete data analyses, also storing time and name of the customer.
User Data:	8 programmable user names.
Print header:	6 lines x 24 characters user-customized.
Line filter:	Replaceable cartridge, 99% efficiency with 20um particles.
Suction pump:	2.0 l/min head at the chimney up to 300 hPa.
Flow measurement:	Internal sensor.
<u>Sample treatment</u>	
<u>Cooler</u>	
Drying system:	Quick moisture condensation with cyclone
Type:	Peltier module
Cooler set-point temperature:	+5° C
Max temp. deviation from the set-point:	+10° C
Condensate drainage:	With peristaltic pump 38 ml/min
Peristaltic pump duty cycle:	30 sec On + 30 sec Off
Warm up time:	15..20 minutes
Operating temperature:	-5° C .. + 45° C
<u>Water trap:</u>	
Type:	Integral to the instrument
Condensate drainage:	With peristaltic pump 38 ml/min
Operating temperature:	-5° C .. + 45° C

Smoke: With external hand pump; input and printing of the smoke index
 Leakage test (if applicable): Performed with AAKT04 accessory: separated report print.
 According to UNI7129-1: 2015 (new systems) or UNI 11137: 2019 (existing systems), with automatic calculation of the piping volume.
 Condensing boiler efficiency: Automatic detection condensing boiler, with efficiency calculation and printout (>100%) based on PCI according to UNI10389-1.
 Ambient gas: Measurement and separate report for ambient CO.
 Draft measurement: According to UNI 10845.
 Performed with the internal sensor connected to port P-.
 0.1 Pa resolution, 0.5 Pa accuracy.

Operating temperature: -5 °C .. +45 °C
 Storage temperature: -20 °C .. +50 °C
 Humidity limit: 20% .. 80% RH
 IP rating: IP42
 Air pressure: Atmospheric
 External dimensions: 50 x 36 x 20 cm (W x H x D)
 50 x 46 x 13 cm (W x H x D)
 with the intermediate tray for transportation of probe and heated head .
 Weight: ~ **12 Kg** (Typical configuration: nine sensors - Cooler - IR bench - flue gas sampling probe - power supply cable - USB cable - shoulder strap - two paper rolls - USB flash drive - condensate drain tube - remote air intake tube - combustion air temperature sensor).
 ~ **13 Kg** (Typical configuration with additional accessories: gas probe 3 mt extension - auxiliary air temperature probe - 300 mm Pitot tube - draft gauge probe).
 ~ **16,7 Kg** (Typical configuration with additional accessories and a middle drawer containing a heated head probe with 300 mm tip and heated tube).

Compliant with European Standards EN 50379-1 and EN 50379-2: See the declaration of conformity (ANNEX E)

6.2 Measurement and Accuracy Ranges

MEASUREMENT	SENSOR	RANGE	RESOLUTION	ACCURACY	
O ₂	Electrochemical sensor	0 .. 25.0% vol	0.1% vol	±0.2% vol	
CO with H ₂ compensation	Electrochemical sensor	0 .. 8000 ppm	1 ppm	±10 ppm	0 .. 200 ppm
				±5% measured value	201 .. 2000 ppm
diluted	Electrochemical sensor	10.00% vol	0.01% vol	±10% measured value	
CO Low range with H ₂ compensation	Electrochemical sensor	0 .. 1000 ppm	0.1 ppm	±2 ppm	0 .. 40.0 ppm
				±5% measured value	40.1 .. 1000.0 ppm
diluted	Electrochemical sensor	100000 ppm	10 ppm	±20% measured value	
CO Mid range	Electrochemical sensor	0 .. 20000 ppm	1 ppm	±100 ppm	0 .. 2000 ppm
				±5% measured value	2001 .. 4000 ppm
diluted	Electrochemical sensor	25.00% vol	0.01% vol	±10% measured value	
CO Hi range	Electrochemical sensor	0 .. 10.00% vol	0.01% vol	±0.02% vol or ±5% m.v.	0 .. 2.00 %
				±5% measured value	2.01 .. 10.00 %
NO	Electrochemical sensor	0 .. 5000 ppm	1 ppm	±5 ppm	0 .. 100 ppm
NO Low range	Electrochemical sensor	0 .. 500 ppm	0.1 ppm	±5% measured value	101 .. 5000 ppm
				±2 ppm	0 .. 40.0 ppm
NO _x	Calculated				
SO ₂	Electrochemical sensor	0 .. 5000 ppm	1 ppm	±5 ppm	0 .. 100 ppm
				±5% measured value	101 .. 5000 ppm
SO ₂ Low range	Electrochemical sensor	0 .. 500 ppm	0.1 ppm	±2 ppm	0 .. 40.0 ppm
				±5% measured value	40.1 .. 500.0 ppm
NO ₂	Electrochemical sensor	0 .. 1000 ppm	1 ppm	±5 ppm	0 .. 100 ppm
				±5% measured value	101 .. 1000 ppm
NO ₂ Low range	Electrochemical sensor	0 .. 500 ppm	0.1 ppm	±2 ppm	0 .. 40.0 ppm
				±5% measured value	40.1 .. 500.0 ppm
C _x H _y	Pellistor sensor	0 .. 5.00% vol	0.01% vol	±0.25% vol	
H ₂ S	Electrochemical sensor	0 .. 500 ppm	0.1 ppm	±5 ppm	0 .. 100.0 ppm
				±5% measured value	100.1 .. 500.0 ppm
NH ₃	Electrochemical sensor	0 .. 500 ppm	0.1 ppm	±10 ppm	0 .. 100.0 ppm
				±10% measured value	100.1 .. 500.0 ppm
H ₂	Electrochemical sensor	0 .. 2000 ppm	1 ppm	±10 ppm	0 .. 100.0 ppm
				±10 % measured value	100 .. 2000.0 ppm
H ₂	Sensore Elettrochimico	0 .. 40000 ppm	10 ppm	±100 ppm	0 .. 1000 ppm
				±10 % valore misurato	1001 .. 40000 ppm
CO ₂	Calculated	0 .. 99.9% vol	0.1% vol		
CO ₂	NDIR sensor	0 .. 20.0% vol	0.01% vol	±0.3% vol	0.00 .. 6.00 %
				±5% measured value	6.1 .. 20 %
CO ₂	NDIR bench	0 .. 50.0% vol	0.1% vol	±0.3% vol	0.00 .. 8.00 %
				±5% measured value	8.01 .. 40.00 %
CO	NDIR Bench	250000 ppm (0 .. 25.0% vol)	1 ppm	±50ppm	0.00 .. 2500 ppm
			10 ppm	±3% measured value	2501 .. 100000 ppm
			10 ppm	±5% measured value	100001 .. 250000 ppm
CH ₄	NDIR Bench	0 .. 1000000 ppm (100% vol.)	1 ppm	±50 ppm	0 .. 200 ppm
				±2% measured value	201 .. 50000 ppm
				±3% measured value	50001 .. 1000000 ppm
CO ₂	NDIR Bench	0 .. 50.0% vol	0.1% vol	±0.3% vol	0.00 .. 8.00 %
				±5% measured value	8.01 .. 40.00 %
				±10% measured value	40.01 .. 50.00 %
CO	NDIR Bench	250000 ppm (0 .. 25.0% vol)	1 ppm	±50ppm	0.00 .. 2500 ppm
			10 ppm	±3% measured value	2501 .. 100000 ppm
			10 ppm	±5% measured value	100001 .. 250000 ppm
HC	NDIR Bench	100000 ppm (0 .. 10.0% vol)	1 ppm	±10% measured value	0 .. 300 ppm
				±3% measured value	301 .. 4000 ppm
				±5% measured value	4001 .. 100000 ppm

MEASUREMENT	SENSOR	RANGE	RESOLUTION	ACCURACY
Air temperature	TcK sensor	-20.0 .. 1250.0 °C	0.1 °C	±1 °C ±1% measured value 0 .. 100 °C 101 .. 1250 °C
Flue gas temperature	TcK sensor	-20.0 .. 1250.0 °C	0.1 °C	±1 °C ±1% measured value 0 .. 100 °C 101 .. 1250 °C
Auxiliary temperature probe	Pt100	-20.0 .. 200.0 °C	0.1 °C	±0.5 °C
Pressure (draft and differential)	Piezoelectric	-10.00 .. 200.00 hPa	0.01 hPa	±1% measured value -10.00 .. -2.01 hPa ±0.02 hPa -2.00 .. +2.00 hPa ±1% measured value +2.01 .. +200.00 hPa
Differential temperature	Calculated	0 .. 1250.0 °C	0.1 °C	
Air index	Calculated	0.00 .. 9.50	0.01	
Excess air	Calculated	0 .. 850 %	1 %	
Stack loss	Calculated	0.0 .. 100.0 %	0.1 %	
Efficiency	Calculated	0.0 .. 100.0 %	0.1 %	
Efficiency (condensing)	Calculated	0.0 .. 120.0 %	0.1 %	
Smoke index	External instrument	0 .. 9		
P ¹ (CO/CO ₂ ratio)	Calculated		0.01%	

Note:

¹: The Poison Index ratio (P.I.) is a reliable indicator of a boiler or burner good operation. It only takes a simple flue gas test to determine whether or not a service is needed to fix the system.

7.0 STARTUP

7.1 Preliminary operations

Remove the instrument from its packing and check it for damage. Make sure that the content corresponds to the items ordered. If signs of tampering or damage are noticed, notify the SEITRON service center or distributor immediately and keep the original packing. A label applied on the instrument carries the model and the serial number. **Both these data should always be stated when requesting technical assistance, spare parts or clarification on the product or its use.**

Seitron maintains an updated database for each and every instrument. Before using for the first time we recommend you charge the batteries completely.

7.2 WARNING

- Use the instrument with an ambient temperature between -5° and +45° C.



IF THE INSTRUMENT HAS BEEN KEPT AT VERY LOW TEMPERATURES (BELOW OPERATING TEMPERATURES) WE SUGGEST WAITING A WHILE (1 HOUR) BEFORE SWITCHING IT ON TO HELP THE SYSTEM'S THERMAL BALANCE AND TO PREVENT CONDENSATE FORMING IN THE PNEUMATIC CIRCUIT.

- After use and before turning the instrument off remove the probe and let ambient clean air through it for at least 30 seconds in order to purge the pneumatic path from all residues of gas.
- Do not use the instrument if the filters are clogged or damp.
- Before placing the measuring probe back in its case after use, make sure it is has cooled down enough and there is no condensate in the tube. It might be necessary to periodically disconnect the filter and the condensate separator and blow compressed air inside the tube to empty all residues.
- Remember to have the instrument checked and calibrated once a year in order to comply with the existing standards.

7.3 Analyzer power supply



STARTING FROM 30 DAYS BEFORE THE DUE DATE OF THE INSTRUMENT CALIBRATION, THE DISPLAY WILL SHOW A MESSAGE REMINDING THE USER TO SEND THE INSTRUMENT TO THE SERVICE CENTER.

Example:



Press and hold for a few seconds

27/10/15
11:51

 **Reminder Calibration**

Annual calibration reminder

Expiration date: 15/07/16

F1: Info service

F2: Ignore

F3: Ignore forever

F1
F2
F3

CONTEXT KEY	FUNCTION
F1	Shows all information relevant to service center.
F2	Temporarily ignores the message. At next turn-on of the instrument the reminder will be shown again.
F3	Permanently ignores the message .

The instrument contains a high-capacity Li-Ion rechargeable battery. The battery feeds the instrument, built-in printer and any other probes or remote devices that may be connected. The instrument runs for approximately 10 hours if the printer is not used or 2 hours with the Cooler active. Should the battery be too low to effect the necessary measurements, the instrument can be hooked up to the mains via the power pack provided, allowing operations (and analysis) to proceed. The battery will be recharged whilst the instrument is being used.

The battery full charging cycle takes up to 8/10 hours. This cycle is automatically ended; the end of the charging cycle is displayed with the turn-off of the red LED located on the front panel as well as with the display which will show the battery and the number '100%'.

WARNING: If the instrument is not going to be used for a long time (e.g. summer) it is advised to store it after a complete charging cycle; furthermore, perform a complete charging cycle once every 4 months.

7.3.1 Checking and replacing the batteries

The state of the internal battery can be displayed during the auto-calibration of the device and possibly later via the information menu.

In the menu, the remaining battery power is displayed.

If battery charge appears to be low, let it discharge completely and then carry out a full 100% charge cycle by connecting the instrument to the mains for 8/10 hours.

If the problem persists, replace the battery pack with a SEITRON original or contact the SERVICE CENTER to carry out the necessary repairs.

The average life of the battery pack is 500 charging/discharging cycles. To exploit this characteristic to the full it is advisable to always use the instrument powered by the internal batteries and to charge it only when it gives the battery flat message.



THE INSTRUMENT IS SHIPPED WITH A BATTERY LEVEL LOWER THAN 30% AS REQUIRED BY CURRENT AIR TRANSPORTATION STANDARDS. BEFORE USE PERFORM A COMPLETE CHARGING CYCLE OF 8 HOURS.

IT IS ADVISABLE TO CHARGE THE BATTERY AT AN AMBIENT TEMPERATURE RANGING BETWEEN 10°C AND 30°C.

The instrument can be left in stock for a period of time depending on the charging level of the battery; below there is a table showing the correlation between stock time and charging level.

BATTERY LEVEL	STOCK TIME
100%	110 days
75%	80 days
50%	45 days
25%	30 days

7.3.2 Use with power supply cord

This instrument can operate even with batteries fully discharged provided it is connected to the mains power through the IEC C14 power cord (supplied).



**THE POWER SUPPLY/BATTERY CHARGER IS SWITCHING TYPE.
THE APPLICABLE INPUT VOLTAGE RANGES BETWEEN 90Vac AND 264Vac.
INPUT FREQUENCY: 50-60Hz.
LINE PROTECTION: 2 FUSES 4A T 5x20 SIZE**

IN CASE OF PROLONGED USE CONNECT THE INSTRUMENT TO MAINS.

7.4 Connection diagram

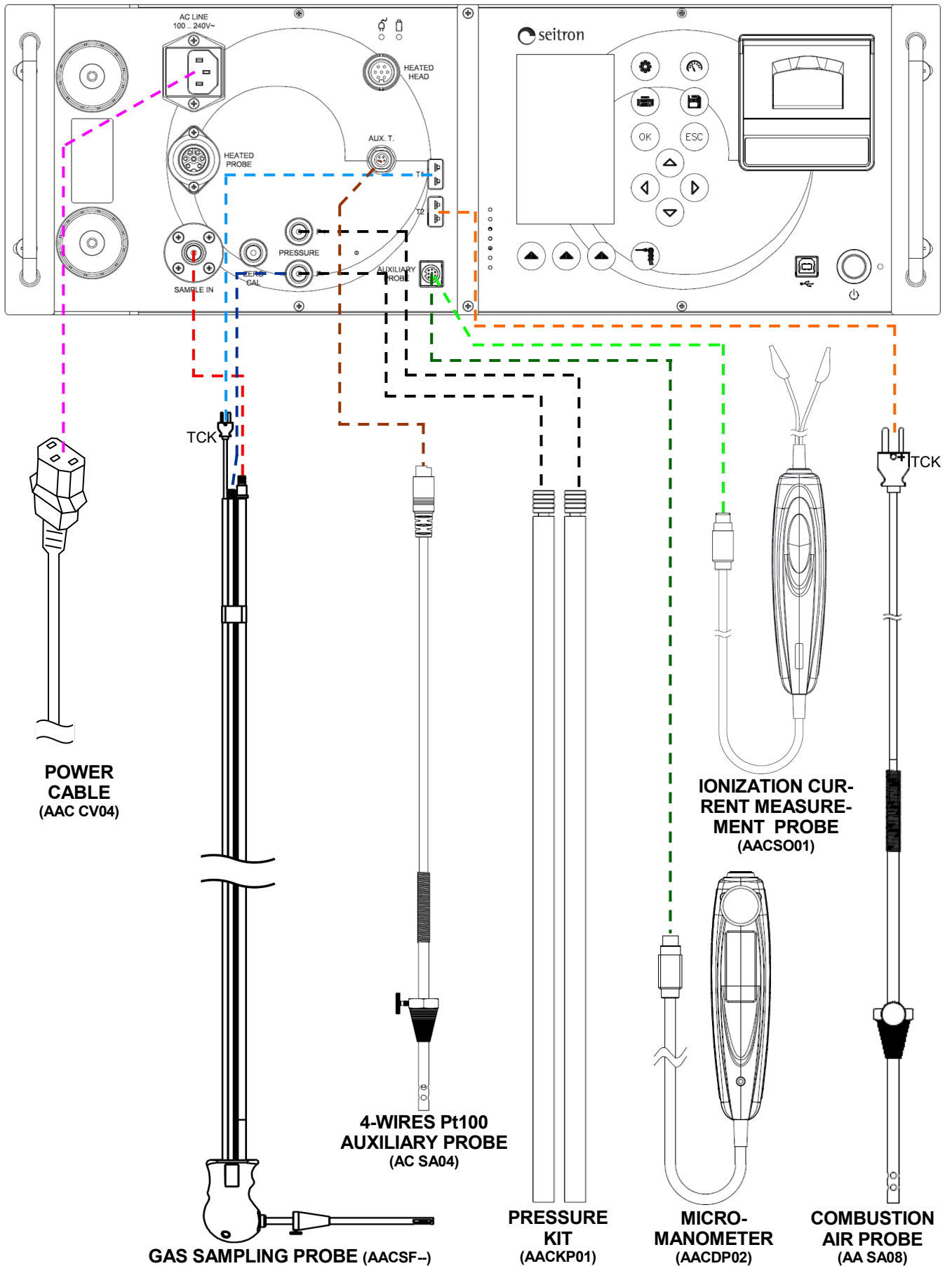

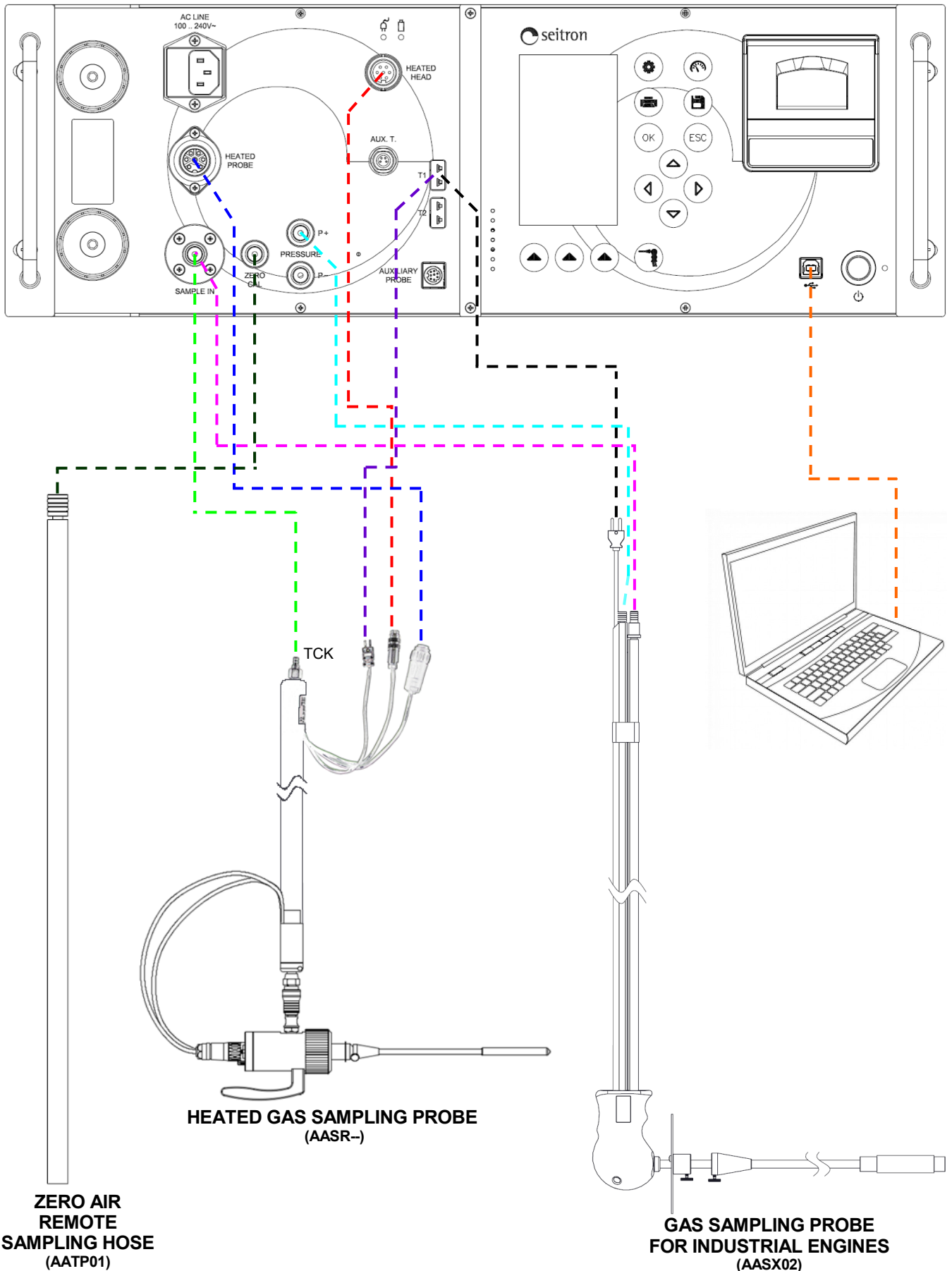

7.4.1 Heated gas sampling line (hose + head with internal AISI 316L stainless steel filter for NOx - SOx measurement)

This optional type of probe is used for applications where the measurement of NOx/SOx is required for long periods of time. This probe can be connected only to combustion analyzers equipped with integrated cooler.

A heated tube allows to keep the gas temperature above the dew point up to the integrated cooler. The Peltier cell conditioning unit allows the drying of the sample thus preventing the dilution of NO2 and SO2 into the condensate water.

The heated gas sampling line (temperature > 90°) allows to sample the gases to be analysed and carry them into the analyzer without condensation occurring on the way in order to avoid that gases like NOx and SOx dissolve in the condensate water making them not measurable by the sensors in the measuring chamber.

The gas, kept warm by the heated line, flows in the instrument passing through an efficient Peltier module cooler which reduces very quickly the gas temperature down to 5°C. This quick thermal shock creates an immediate condensation of the water in a dedicated tank; the gas, now dried, is therefore carried to the measuring chamber. The condensation water resulting from the combustion process is then extracted from the analyzer with a peristaltic pump. Applications that have very dirty fumes require a pre-filtration system right after the point where the samples are taken: for this purpose the head is equipped with a filter made of Synthesized stainless steel (1257 cartridge 95% eff. 40µm). In order to avoid condensation and therefore the dissolution of NOx and SOx in the water, the filter is heated up to a temperature higher than 90° C.

This filter can be cleaned in an ultrasonic bath or using solvents and steel brushes.

Technical features:

Tip: Material: AISI 304 stainless steel
 Diameter: 8 mm
 Length: 300mm
 1000mm

Heated head:

Material: Anodised aluminium (black)
 Synthesized AISI 316L stainless steel internal filter (95% eff. with 40µm particles)
 Power supply: From the instrument with round DIN 7 poles connector
 Temperature control: TcK thermocouple
 Temperature set-point: Adjustable from 90°C to 130°C

Heated hose:

Material: Internal measurement hose: Teflon
 External insulation: water-repellent
 Length: 3 m
 Bending radius: 140 mm
 Power per meter: 65 Watt
 Power supply: From the instrument with special R24 connector
 110Vac - 230Vac automatic voltage switching
 Temperature control: NTC 10k
 Temperature set-point: Adjustable from 90°C to 130°C

Temperature sensor:

Type K thermocouple (Ni-NiCr) - IEC584 - class 1 500mm
 Type K thermocouple (Ni-NiCr) - IEC584 - class 1 1000mm

Available probes:

WARNING: The heated probe and heated head can only be used if the analyzer is connected to the mains, with AC voltage between 90 V and 264 V.

Connection:

Code:	Heated head with Synthesized filter	Type K thermocouple	300 mm tip	1000 mm tip	3 m electrically heated hose
AASR03	✓	✓	✓		✓
AASR04	✓	✓		✓	✓

For the gas sampling heated line [see section 7.4.](#)

7.4.2 Gas probe for industrial engines

This type of probe is typically used in processes where the fumes sampled are very dirty and must be filtered out before reaching the measurement instrument. To preserve the internal system it is mandatory to filter the dust out of the gas directly on the probe tip, using an AISI 316L stainless steel filter. Condensate and fumes are then separated inside the instrument using the internal separation assembly. The probe tip is provided with a flange that acts as a heatsink to make sure that, in case of very high temperature at the chimney, the handle is not damaged by a temperature that might exceed 100 .. 120° C (max. allowed temperature).

Technical features:

Tip:	Material:	AISI 304 stainless steel
	Diameter:	8 mm
	Length:	750mm rigid tip + flange, insertion depth 600 mm
Handle:	Material:	Nylon
	Color:	Black
Hose:	Material:	EPDM
	Length:	3 m
Filter:	AISI 316L Syntherized stainless steel, washable with ultrasonic bath or with solvents and steel brush.	
Temperature sensor:	Type K thermocouple (Ni-NiCr) - IEC584 - Class 1	
Pneumatic connectors:	Male - 8.9 mm diameter Male - 8.0 mm diameter	
Temperature sensor connector:	TcK mignon size	
Operating temperature:	max. 800°C	

7.4.3 Probe with heated head for carbon black measuring.

This kind of probe, optionally available, is used for the carbon black measuring. The heated head (temperature > 90°) avoid the formation condensation that might be deposited on the filter paper.

Technical features

Tip:	Material:	AISI 316L stainless steel
	Diameter:	8 mm
	Length:	300mm rigid 750mm rigid
Adapter for wells:	Material:	Galvanized steel
	External diameter:	10.. 20 mm
Handle:	Material:	Nylon
	Color:	Black
Hose:	Material:	EPDM
	Length:	3,5 meters
Temperature sensor:	Type K thermocouple (Ni-NiCr) - IEC584 - Class 1	
Pneumatic connectors:	Male - 8.9 mm diameter pressure connections Male - 8.0 mm diameter gas input connection	
Electric signals connectors:	for pressure measuring and heater power.	
Operating temperature:	AA SX04:	max. 600°C immersion depth 160mm
	AA SX05:	max. 800°C immersion depth 500mm



USING THE PROBE WITH HEATED HEAD FOR THE MEASUREMENT OF THE CARBON BLACK REDUCES THE INSTRUMENT'S BATTERY AUTONOMY.

Connection:

For the wiring connection of the fumes heating sampling line [see section 12.3.2](#).

7.4.4 Combustion air temperature sensor

This probe is used to measure the temperature of the combustion air.

Use: to be used when the sampling site of the combustion air is located in a different area than the boiler room or the heating plant; when the combustion air sampling site is located in a different place than the boiler room, the temperature of the combustion air can be very different compared with the temperature of the air in the boiler room, generating a less accurate efficiency calculation.

Technical features:

Tip:	Material:	AISI 304 stainless steel
	Diameter:	6 mm

	Length:	200 mm rigid tip
Adapter for thermowells:	Material:	AISI 303 stainless steel
	External diameter:	7,5 .. 17 mm
Temperature sensor:	Sensing element:	Type K thermocouple (Ni-NiCr) - IEC584 - Class 1
	Cable length:	2 m
Connector:	TcK mignon size	
Measurement range:	-25.0°C .. +125.0°C	

Connection

As shown in [section 7.4](#) the probe must be connected to the instrument as follows:

- ◆ The polarized male connector of the thermocouple must be connected to the **T2** plug. The improper insertion of the same is not possible thanks to the different length of the tips.

7.4.5 Tc-K temperature measurement probe

Using the same input as for the Tc-K thermocouple 'T1' (i.e. the one used for gas temperature), it is possible to measure the supply and return water temperature. If this temperature is taken on the pipe itself, it is suggested to use contact probes with diameter matching as close as possible the pipe diameter.

Connection

As shown in [section 7.4](#) the probe must be connected to the device as follows:

- ◆ The polarized male connector of the thermocouple must be connected to the '**T1**' plug. The improper insertion of the same is not possible thanks to the different lengths of the tips.

7.4.6 Auxiliary temperature measurement probe

Input for 4-wires Pt100 temperature probe.

Connection

As shown in [section 7.4](#) the probe must be connected to the device as follows:

- ◆ The 4-poles M8 type connector must be connected to the '**AUX T**' plug on the analyzer.

7.4.7 Ionization current measurement probe

This special probe has been developed to extend the functions of the analyzer to check the quality of the combustion flame.

This probe allows the combustion analyzer to measure the current that is created within the combustion chamber between the chamber metal body and the measurement electrode.

Connection

As shown in [section 7.4](#) the probe must be connected to the device as follows:

- ◆ The 8-poles mini-DIN type connector must be connected to the '**AUXILIARY PROBE**' serial port on the analyzer.

7.4.8 Draft measurement gauge

This device has been designed to extend the functions of the combustion analyzer to the draft measurement in compliance with the UNI 10845 standard. It enables the combustion analyzer to measure the draft and generally the pressure with an higher accuracy and resolution than the internal sensor of the instrument.

Connection

As shown on the [section 7.4](#) the probe shall be connected to the instrument as follows:

- ◆ The draft gauge is provided with a female connector (ø 9mm) of the same type of the one for the pressure inputs on the combustion analyzer. Thanks to this connector the draft gauge can be connected directly to the shorter male connector (ø 9mm) of the flue gas sampling probe supplied.
- ◆ The 8-pole MiniDin connector shall be connected to the "**AUXILIARY PROBE**" serial port of the analyzer.

7.4.9 Pressure Test Kit

Two types of pressure measurement kit are available:

- 1st Kit includes two 1mt hoses and two ø 9mm fittings; to be used for the differential pressure measurement.
- 2nd Kit includes one 1mt hose and one ø9mm fitting for pressure measurement.

Connection

As shown on [section 7.4](#) the kits shall be connected to the instrument as follows:

- 1st hose connector shall be connected to the P+ connector, while the other hose connector shall be connected to the analyzer P- connector.
- 2nd The hose connector shall be connected to the analyzer P+ or P- connector.

7.4.10 Burner pressure verification probe

This probe must be used to measure the burner pressure of the gas-powered boiler so it can be regulated in real time. It is made of a silicone tube, 8x4mm and 1 metre long, complete with connector for connecting to the analyzer.

7.4.11 Hose for remote zero air suction

It consists of one 2mt tube and one \varnothing 9mm male fitting to be used to move the clean air suction point to perform the instrument autozeroing.

Connection

As shown on [section 7.4](#) the tube shall be connected to the instrument as follows:

- ♦ The tube fitting shall be connected to the analyzer " **ZERO CAL** " pneumatic connector.

8.0 POWER ON - OFF

8.1 Starting the device

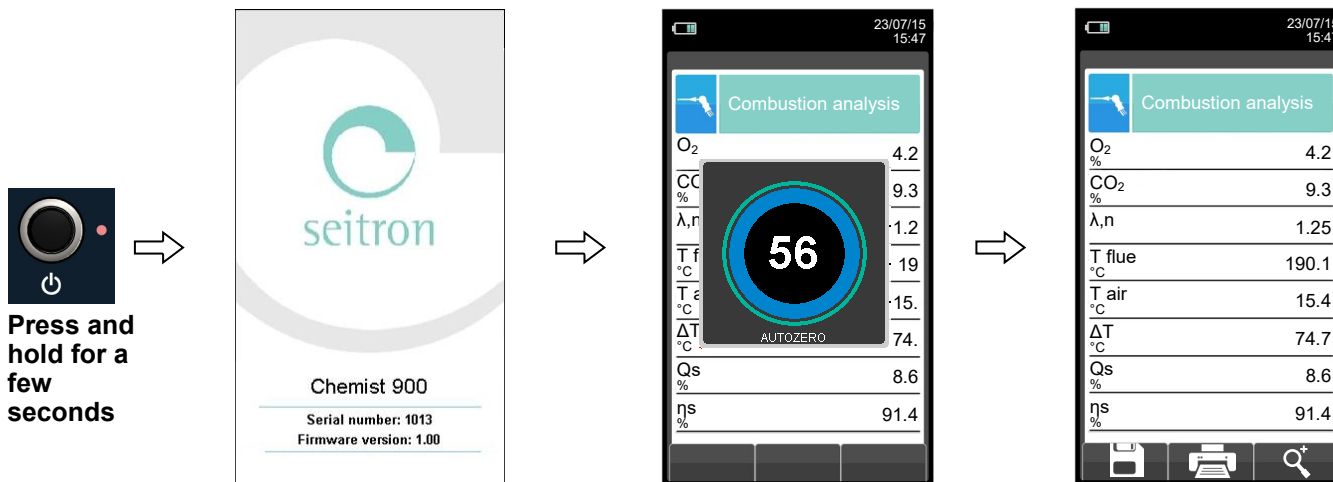

During autozero, you can only use the menus that do not require autozero.

ERROR

Autozero failed.
Repeat?

F1: Autozero
F2: Analysis
F3: Diagnostic

This error message is displayed if the autozero of the device is not successfully completed.

KEY	FUNCTION
	Activate the context keys shown on the display.
	Goes through the measurements available.
	Activates the context key located in the left side of the display.
	Returns to the previous screen.

CONTEXT KEY	FUNCTION
	Repeats autozero (is shown in the case of an error).
	The device will suspend autozero and display the screen "Combustion Analysis"; it is possible to carry out the analysis of combustion (displayed in the case of an error).
	The device displays the screen "Sensor Diagnostics" (displayed in the case of an error).
	Save analysis.
	Print the test paper print-out according to the settings.
	Zoom. By pressing this interactive key repeatedly, the device displays the following sequence: AAA → AAA → AAA → AAA

9.1 Configuration menu

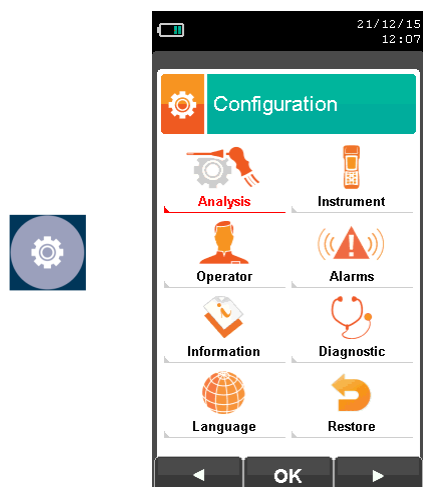

KEY	FUNCTION
	Activate the context keys shown on the display.
	Returns to the previous screen.

CONTEXT KEY	FUNCTION
	Selects the available parameters.
	Enters in the selected parameter setting.
	Selects the available parameters.

PARAMETER	DESCRIPTION
Analysis	Through this menu the user can configure the available parameters for a proper combustion analysis. SEE SECTION 9.2.
Instrument	This menu is used to configure the instrument's reference parameters. SEE SECTION 9.3.
Operator	In this sub menu you can enter or change the name of the operator that will carry out the analysis. Up to 8 lines are available. Also, you can select the name of the operator that will carry out the analysis and this will be printed on the analysis report. SEE SECTION 9.4.
Alarm	This submenu allows the user to set and memorize 10 alarms, defining the monitored parameter for each (gas, pressure, Ta, Tf), the alarm threshold and relevant measurement unit and whether it is a low or high-level alarm. Low-level alarms are triggered when the reading drops below the defined threshold, whereas high-level alarms are triggered when the reading rises above the defined threshold. SEE SECTION 9.5.
Information	This menu provides information regarding instrument status. SEE SECTION 9.6.
Diagnostic	The user, with this menu, can check any anomalies of the device. SEE SECTION 9.7.
Language	Set the desired language for the various menus and the test paper print-out. SEE SECTION 9.13.
Restore	Restore factory settings. SEE SECTION 9.14.

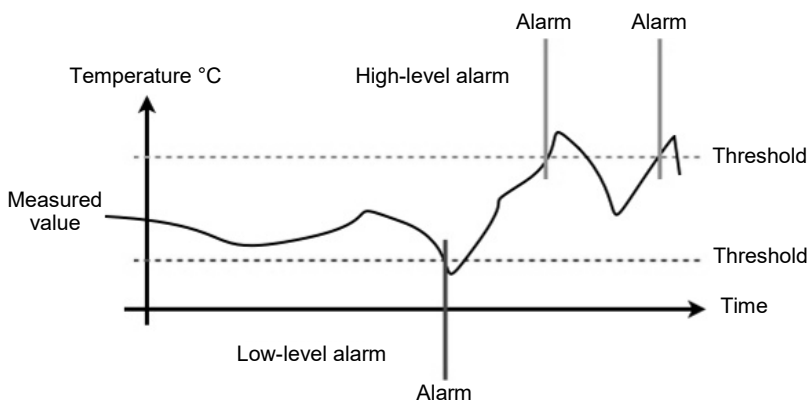

9.2 Configuration → Analysis

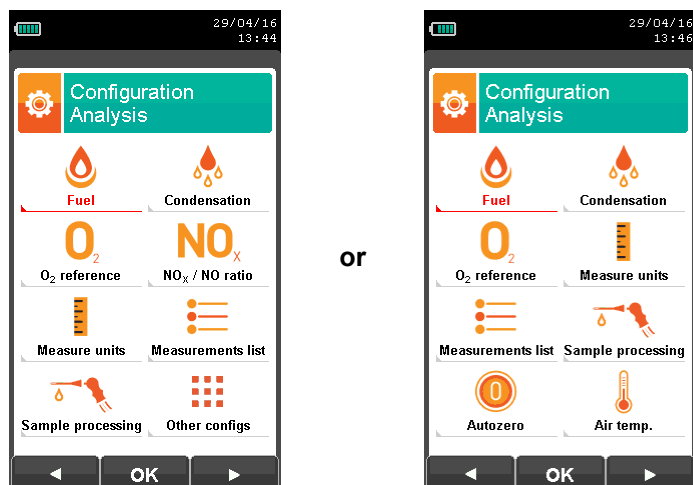







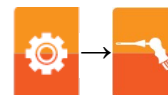

KEY	FUNCTION
	Activate the context keys shown on the display.
	Returns to the previous screen.

CONTEXT KEY	FUNCTION
	Selects the available parameters.
	Enters in the selected parameter setting.
	Selects the available parameters.

PARAMETER	DESCRIPTION
Fuel	Lets the user select the type of fuel to be used during analysis. Fuel selection can be done either from this menu or during the analysis itself. By selecting the sub menu Fuel coefficients the user can view the characteristics of the fuels used in the calculation of performance. SEE SECTION 9.2.1.
Condensation	The burner efficiency figure when condensation takes place is influenced by atmospheric pressure and humidity of the combustion air. As the atmospheric pressure is hardly precisely known, the operator is asked to enter a related parameter, i.e. the altitude of the place above the sea level, from which the pressure is then derived once the dependency from atmospheric conditions is neglected. In calculations the value of 101325 Pa is assumed as atmospheric pressure at sea level. Further the air relative humidity input is allowed, being this calculated at the combustion air temperature as measured from the instrument; in case this value is unknown the operator is recommended to enter 50% for this value. SEE SECTION 9.2.2.
O ₂ reference	In this mode the user can set the oxygen percentage level to which pollutant emission values detected during analysis will be referenced. SEE SECTION 9.2.3.
NO _x /NO ratio	NO _x /NO: all the nitrogen oxides which are present in the flue emissions (Nitrogen oxide = NO, Nitrogen dioxide = NO ₂); total nitrogen oxides = NO _x (NO + NO ₂). In the combustion processes, it is found out that the NO ₂ percentage contained in the gas is not far from very low values (3% or above); hence it is possible to obtain the NO _x value by a simple calculation without using a direct measurement with a further NO ₂ sensor. The NO ₂ percentage value contained in the gas can be however set at a value other than 3% (default value). This menu is only available when the NO ₂ sensor is not installed. SEE SECTION 9.2.4.



PARAMETER	DESCRIPTION
 <p>Measure units</p>	<p>Through this submenu the user can modify the measurement units for all the analysis parameters, depending on how they are used. SEE SECTION 9.2.5.</p>
 <p>Measures list</p>	<p>In this sub menu the user can see the list of measurements that the device can perform. With the interactive keys, the user can add, delete or move a selected measurement. SEE SECTION 9.2.6.</p>
 <p>Sample processing</p>	<p>In this mode the user can activate/deactivate the whole operating system of the heated probe. The user can also set the required temperature of the heated tube and the heating head. The activation of the Cooler system is indicated on the display with the icon "  ".</p> <div style="border: 1px solid black; padding: 5px; margin: 10px 0;">  <p>WHEN THE INSTRUMENT COOLER SYSTEM IS TURNED ON, THE BATTERY LIFE IS REDUCED DOWN TO 2 HOURS.</p> </div> <p>SEE SECTION 9.2.7.</p>
 <p>Other config.</p>	<p>If the ' NOx/NO Ratio ' parameter is provided, the instrument shall display this icon which represents the ' Autozero ' and ' Air Temperature ' menus described below.</p>
 <p>Autozero</p>	<p>In this sub menu the user can change the length of the autozero cycle of the analyzer and start it manually. SEE SECTION 9.2.8.</p>
 <p>Air temp.</p>	<p>This submenu allows to acquire or enter manually the combustion air temperature. SEE SECTION 9.2.9.</p>

9.2.1 Configuration → Analysis → Fuel

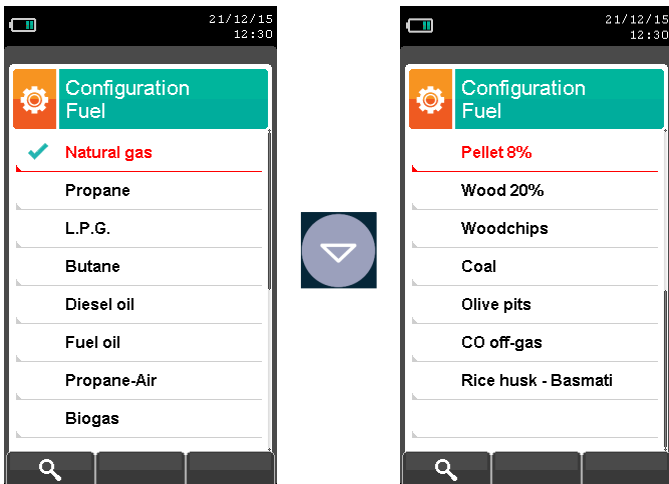
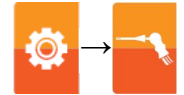

KEY	FUNCTION
	Activate the context keys shown on the display.
	The arrows select each line displayed.
	Confirms the choice of fuel to be used during the analysis.
	Returns to the previous screen.

CONTEXT KEY	FUNCTION
	Shows the details of the selected fuel (see example below).
	Returns to the previous screen.

Example:

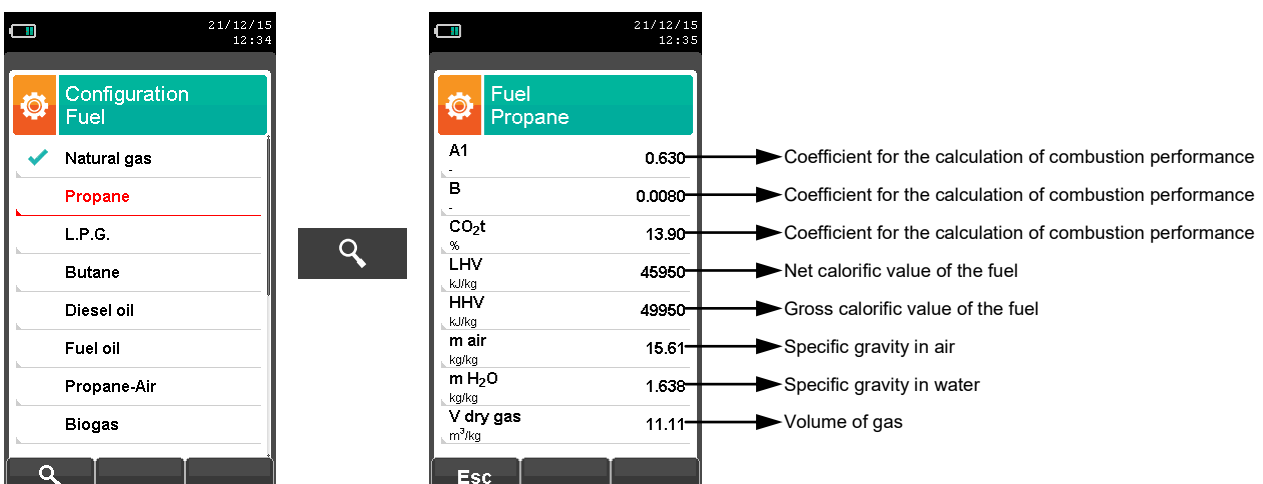

9.2.2 Configuration → Analysis → Condensation

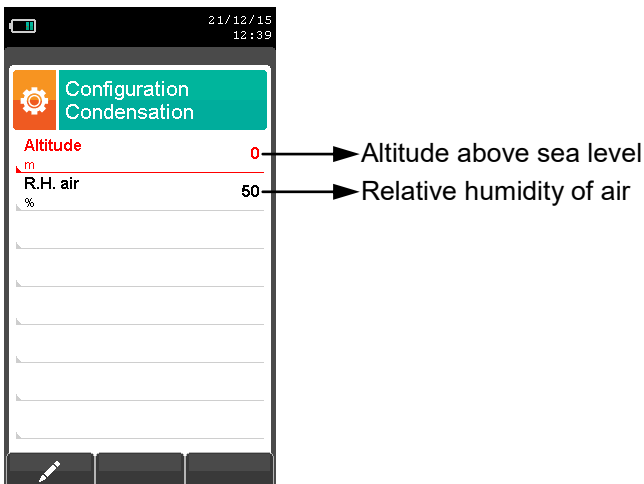
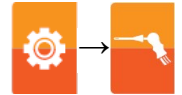

KEY	FUNCTION
	Activate the context keys shown on the display.
	The arrows select each line displayed (the selected line is red). In edit mode, it scrolls through the suggested values.
	Enters the modify mode for the selected parameter, then confirms the modification.
	When pressed in modify mode cancels the selection made, otherwise returns to the previous screen.

CONTEXT KEY	FUNCTION
	Enters the modification mode for the selected parameter.
	Confirms the modification.

Example:

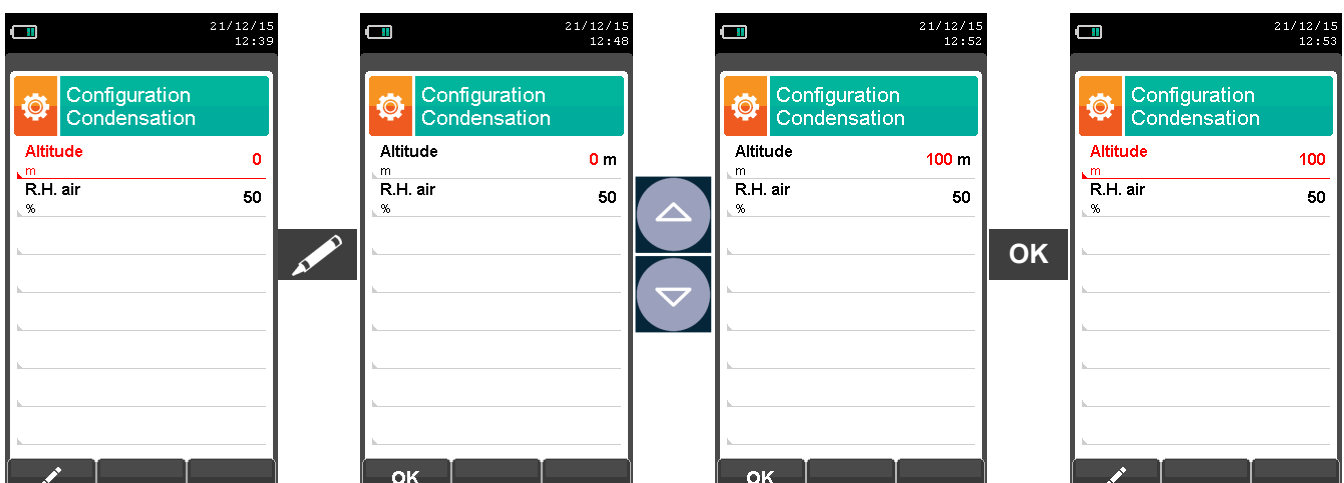

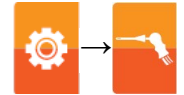

9.2.3 Configuration → Analysis → Reference O₂

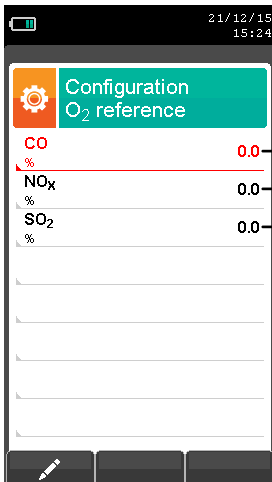

- Oxygen Reference Level for the CO measurement.
- Oxygen Reference Level for the NO_x measurement.
- Oxygen Reference Level for the SO₂ measurement.

KEY	FUNCTION
	Activate the context keys shown on the display.
	Keys '▲' and '▼' select any line shown on the display (the selected line is displayed in red). When in modify mode, sets the desired value.
	Enters the modify mode for the selected parameter, then confirms the modification.
	When pressed in modify mode cancels the selection made, otherwise returns to the previous screen.

CONTEXT KEY	FUNCTION
	Enters the modify menu for the selected parameter.
	Confirms the modification.

Example:

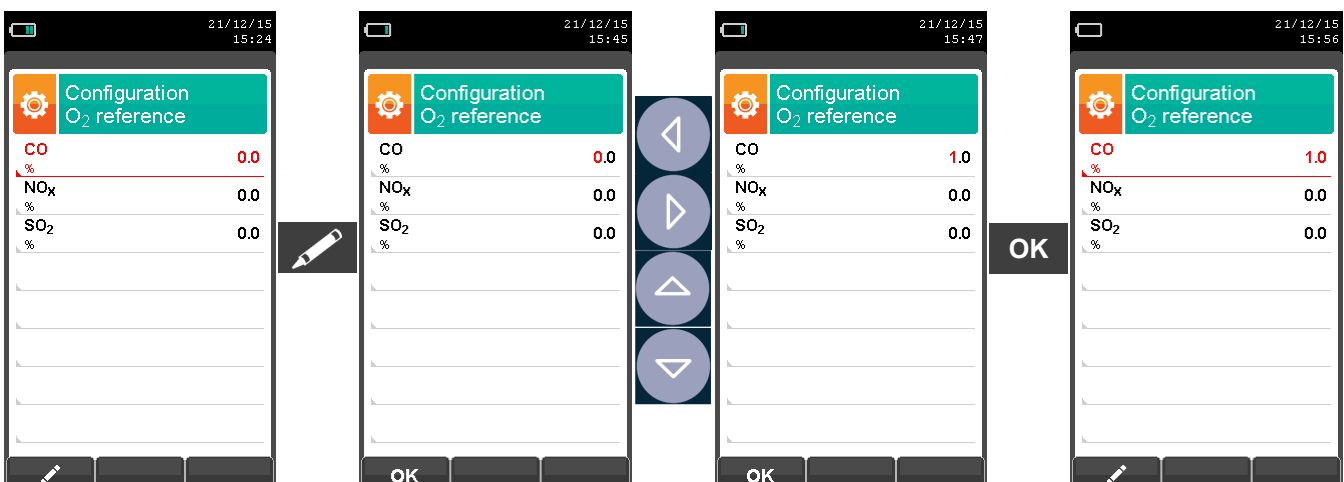

9.2.4 Configuration → Analysis → NO_x/NO ratio

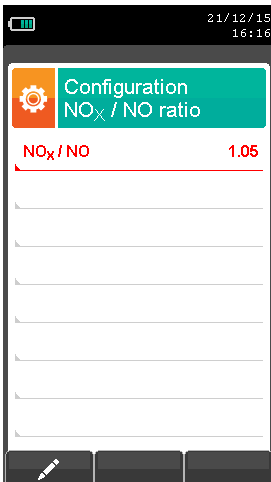
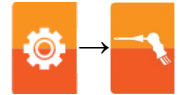

KEY	FUNCTION
	Activate the context keys shown on the display.
	When in modify mode, sets the desired value.
	Enters edit mode of the selected element and then confirms the change.
	When pressed in modify mode cancels the selection made, otherwise returns to the previous screen.

CONTEXT KEY	FUNCTION
	Enters edit mode.
	Confirms the modification.

Example:

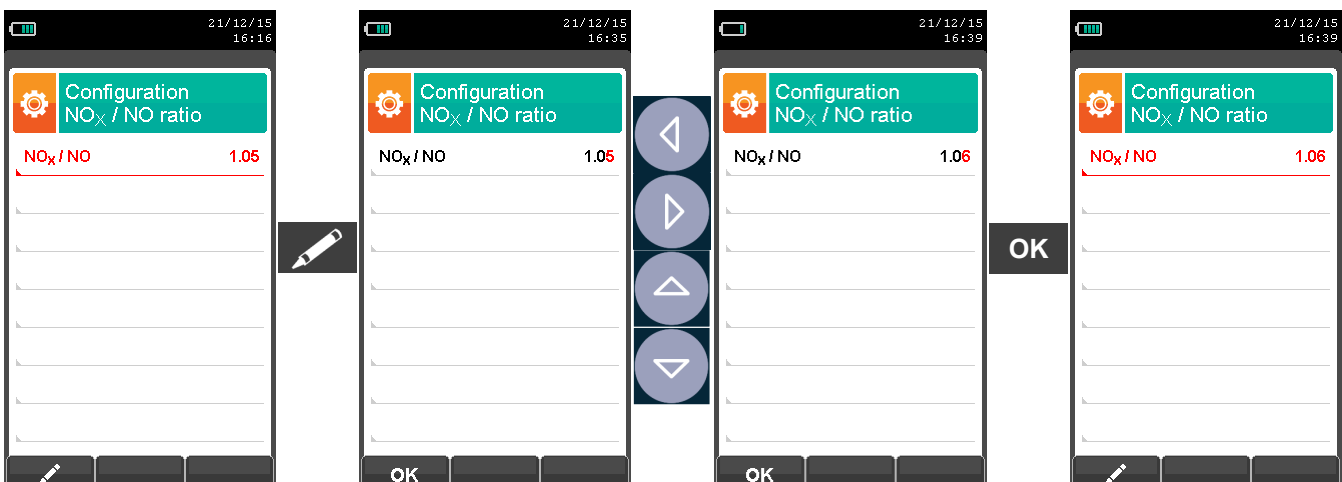

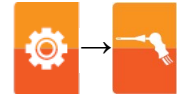

9.2.5 Configuration → Analysis → Measurement units

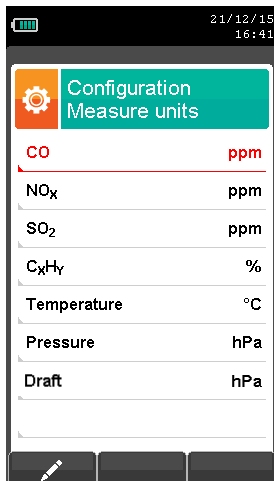

- Measurement unit can be set as: ppm - mg/m³ - mg/kWh - g/GJ - g/m³ - g/kWh - % - ng/J
- Measurement unit can be set as: ppm - mg/m³ - mg/kWh - g/GJ - g/m³ - g/kWh - % - ng/J
- Measurement unit can be set as: ppm - mg/m³ - mg/kWh - g/GJ - g/m³ - g/kWh - % - ng/J
- Measurement unit can be set as: ppm - mg/m³ - mg/kWh - g/GJ - g/m³ - g/kWh - % - ng/J
- Measurement unit can be set as: °C - °F
- Measurement unit can be set as: hPa - Pa - mbar - mmH₂O - mmHg - inH₂O - psi
- Measurement unit can be set as: hPa - Pa - mbar - mmH₂O - mmHg - inH₂O - psi



The measurement units mg/m³ and g/m³ are referred to Normal pressure and temperature conditions, P = 101325 Pa and T = 0 °C.

KEY	FUNCTION
	Activate the context keys shown on the display.
	Keys '▲' and '▼' select any line shown on the display (the selected line is displayed in red). When in modify mode, sets the desired value.
	Enters edit mode of the selected element and then confirms the change.
	When pressed in modify mode cancels the selection made, otherwise returns to the previous screen.

CONTEXT KEY	FUNCTION
	Enters the modification mode for the selected parameter.
	Confirms the modification.

Example:

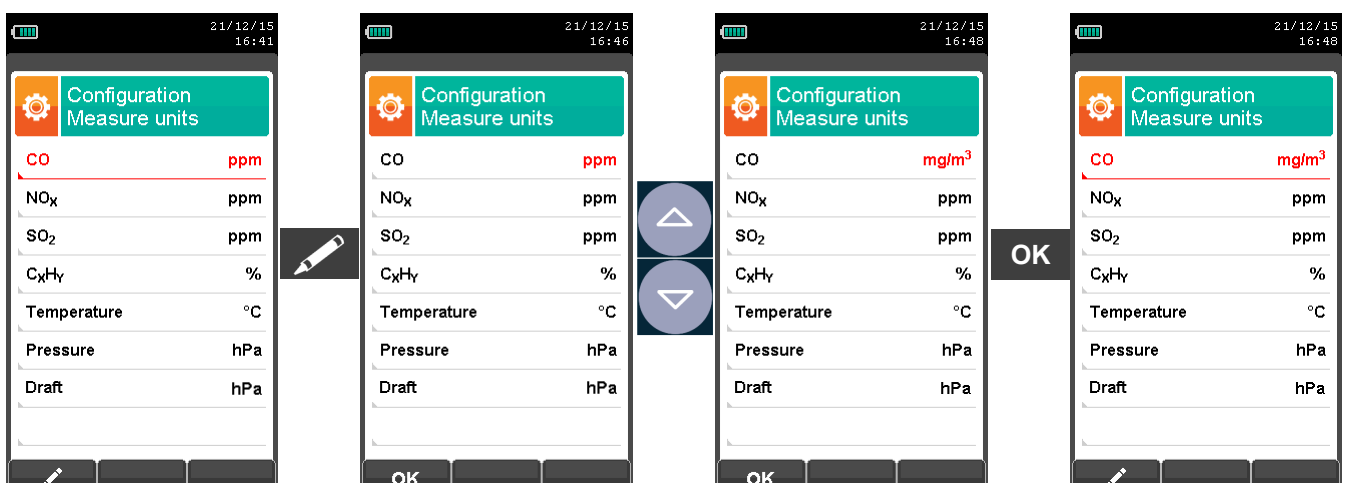





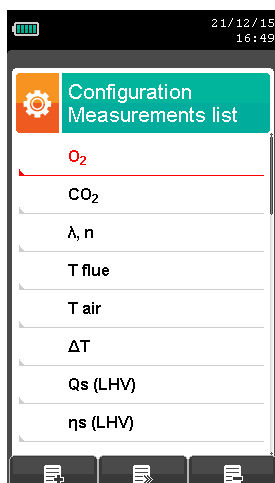







9.2.6 Configuration→Analysis→Measures list



 FOR FURTHER DETAILS SEE THE [ANNEX D](#)

KEY	FUNCTION
	Activate the context keys shown on the display.
	Select each line displayed (the line selected is red). In edit mode, it sets the desired value.
	When pressed in modify mode cancels the selection made, otherwise returns to the previous screen.

CONTEXT KEY	FUNCTION
	Adds a line to the list of available measurements.
	Activates the movement of a measurement from its current position.
	Deletes a measurement from the list of available measurements.
	After the activation of the function '  ': It scrolls through the available measurements. After the activation of the function '  ': It moves the element from its current position.
	Confirms the operation.
	Cancels the operation.



OTHER THAN THE MEASUREMENT LIST ABOVE, IT IS POSSIBLE TO VISUALIZE THE MEASURE OF THE DETECTED GAS ALSO IN PPM, DEPENDING ON THE KIND OF MEASUREMENT CELL IN THE INSTRUMENT. IF IT IS NECESSARY TO MEASURE THE VALUE OF GAS WITH TWO DIFFERENT MEASUREMENT UNITS, SELECT IN THE MEASUREMENTS LIST THE DESIRED GAS IN PPM AND CHANGE THE MEASUREMENT UNIT FOR THE SAME GAS IN THE "CONFIGURATION->ANALYSIS->MEASUREMENT UNIT" SCREEN. NOW THE INSTRUMENT ACQUIRES THE MEASURE WITH TWO DIFFERENT UNITS (PPM AND THE ONE PREVIOUSLY SET)

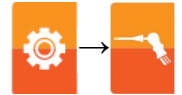

Example:

1. Add a measurement to the list - example

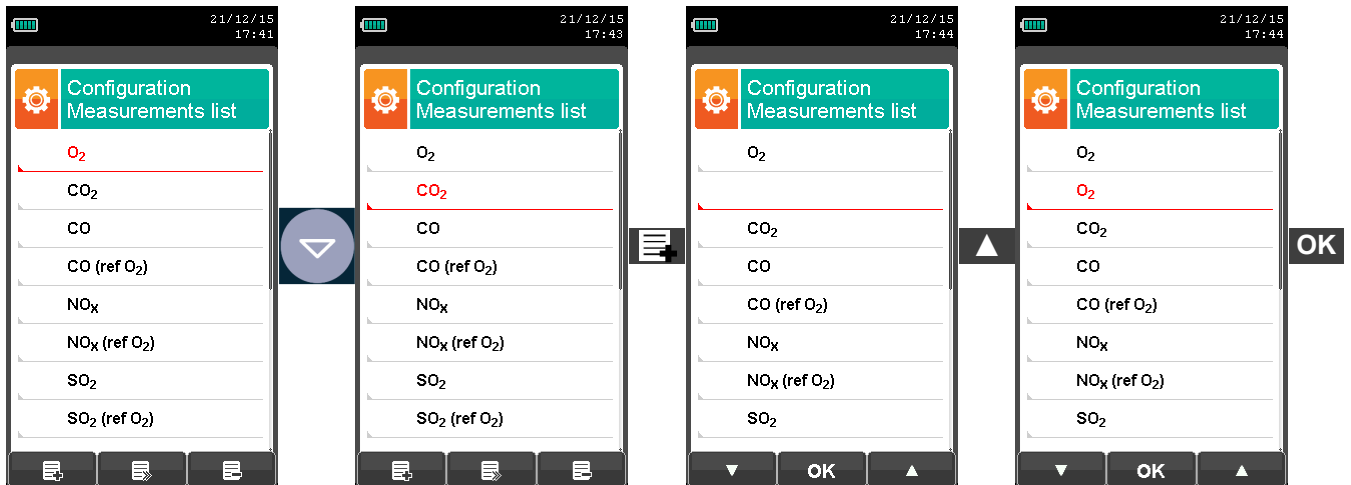

2. Change the position of a measurement - example

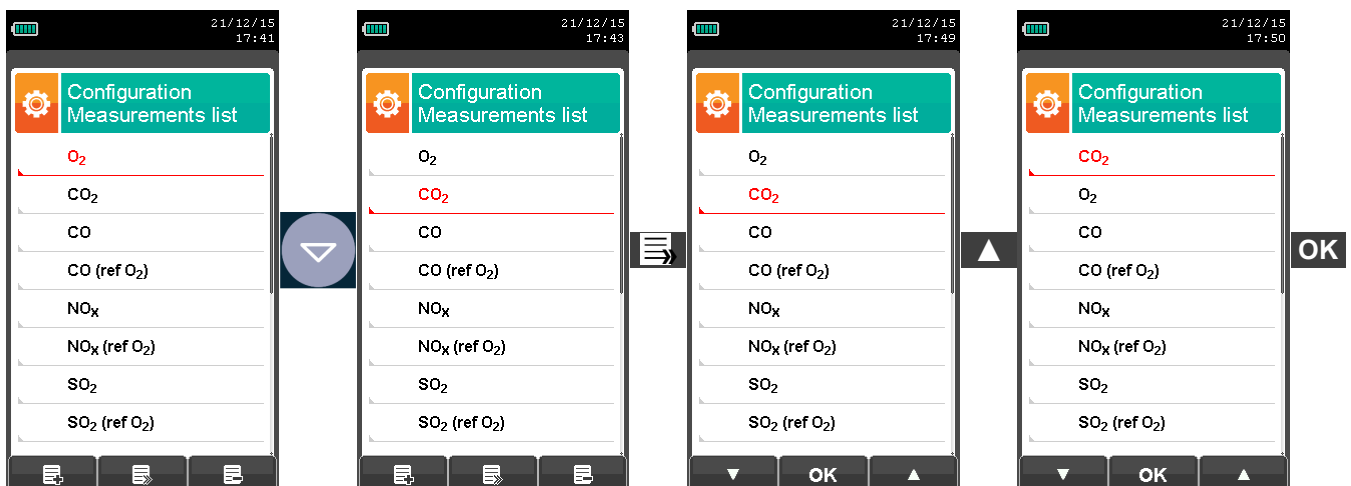

3. Delete a measurement from the list - example

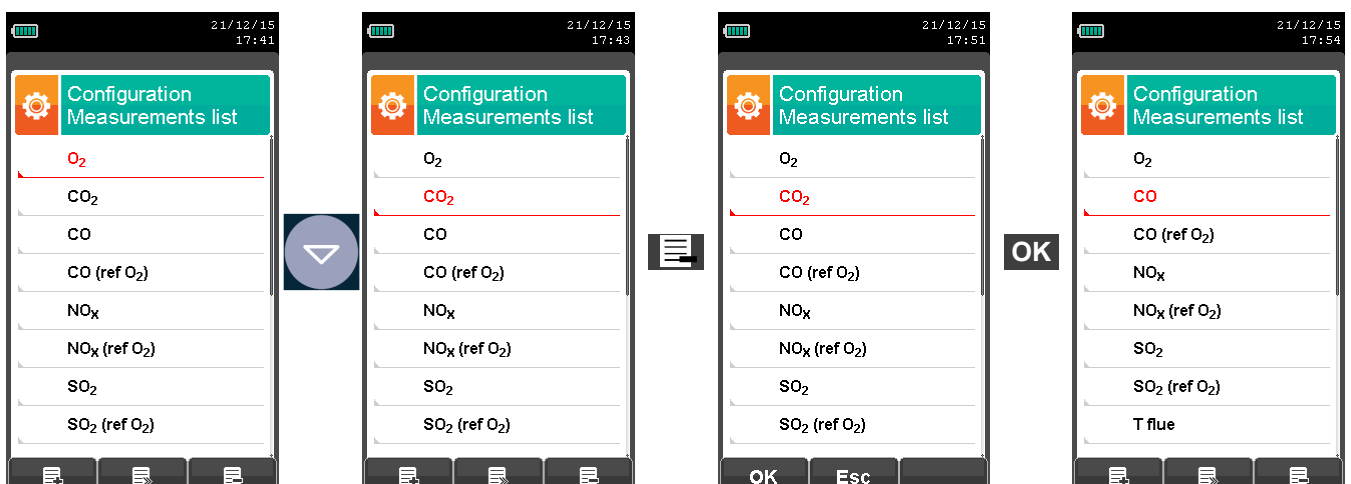

9.2.7 Configuration → Analysis → Sample processing

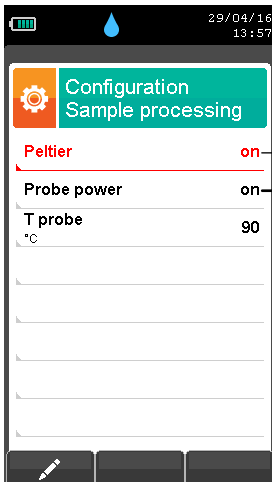
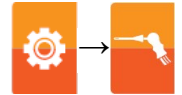

- Available settings: on (Cooler is switched on) or off (Cooler is switched off).
- Available settings: on (Heated Tube and Probe are switched on) or off (Heated Tube and Probe are switched off).
- Heated tube and heated head probe temperature: 90°C .. 130°C.

WARNING

The activation of the Cooler system is indicated on the display with the icon “”

KEY	FUNCTION
	Activate the context keys shown on the display.
	The arrows '▲' and '▼' select each line displayed (the selected line is highlighted in red). When in modify mode, sets the desired value.
	Enters the modify mode, then confirms the modification.
	When pressed in modify mode, it cancels the selection made or returns to the previous screen.

CONTEXT KEY	FUNCTION
	Enters the modification mode for the selected parameter.
	Confirms the modification.

Example:

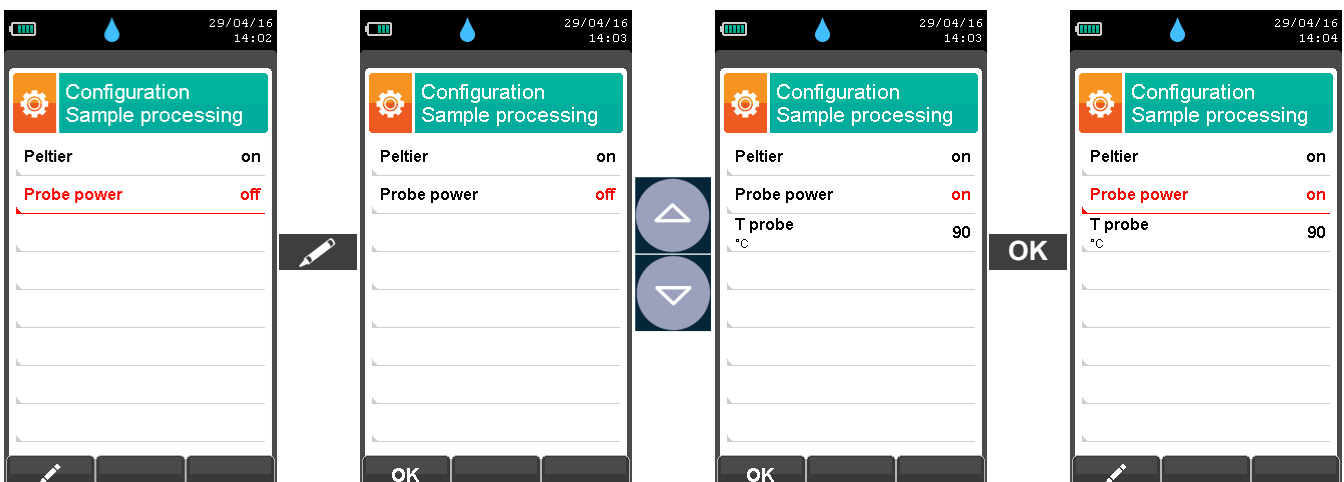

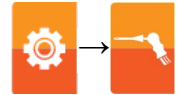

9.2.8 Configuration → Analysis → Autozero



- Duration of autozero, expressed in seconds.
- Duration of the cleaning cycle, expressed in seconds.

KEY	FUNCTION
	Activate the context keys shown on the display.
	The arrows '▲' and '▼' select each line displayed (the selected line is highlighted in red). When in modify mode, sets the desired value.
	Enters edit mode of the selected element and then confirms the change.
	When pressed in modify mode cancels the selection made, otherwise returns to the previous screen.

CONTEXT KEY	FUNCTION
	Enters the modify menu for the selected parameter.
	Confirms the modification.
	Starts autozero for the selected duration.

Example:

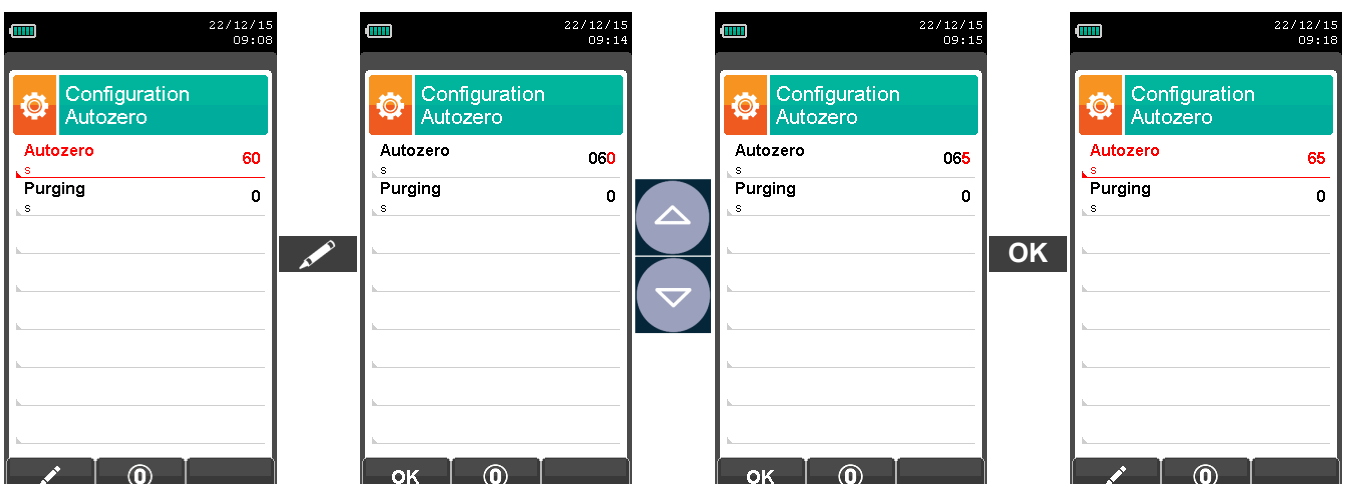

9.2.9 Configuration→Analysis→Air temperature

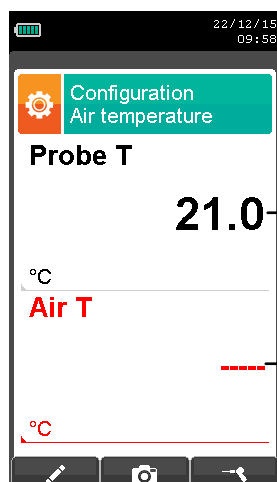
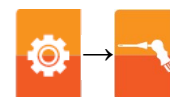

21.0 → Combustion air temperature detected by the Tc-K probe connected to the T1 connector. If the probe is not connected, a sensor error is displayed.

----- → Combustion air temperature entered manually or detected by the Tc-K probe.

KEY	FUNCTION
	Activate the context keys shown on the display.
	When in modify mode, sets the desired value.
	Activates the context key located in the left side of the display.
	Returns to the previous screen without saving the changes made.

CONTEXT KEY	FUNCTION
	Enters the modify mode for the "Air T" parameter: the user can set the required air temperature value to be used during the combustion analysis.
	Saves the value acquired or entered in the "Air T" parameter.
	Acquires the temperature value detected by the flue gas sampling probe. This value is shown on the "Air T" parameter.
	Confirms the modification .

Example:

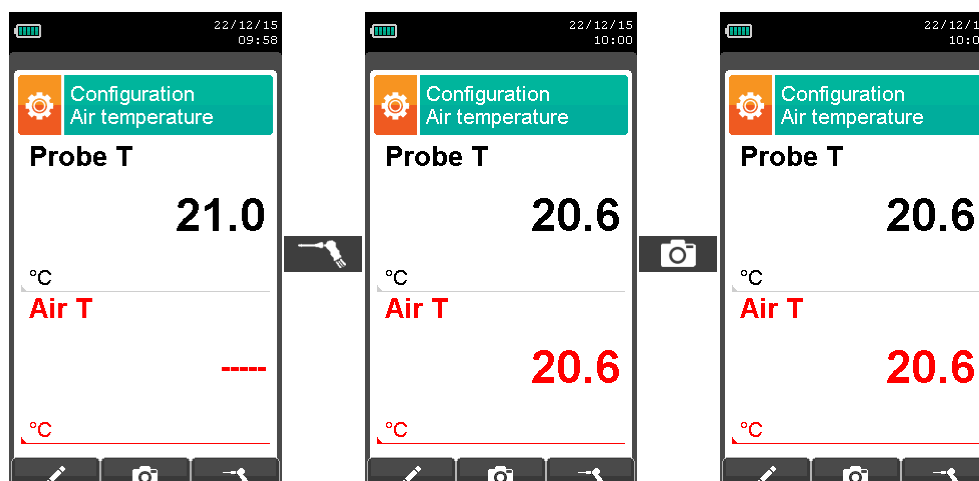

9.3 Configuration→Instrument

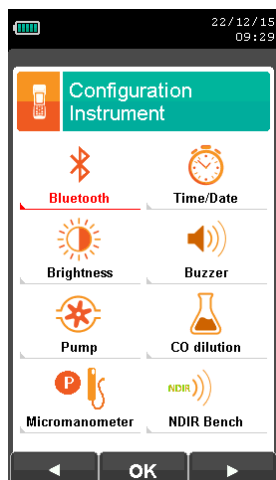



KEY	FUNCTION
	Activate the context keys shown on the display.
	Returns to the previous screen.

CONTEXT KEY	FUNCTION
	Selects the available parameters.
	Enters in the selected parameter setting.
	Selects the available parameters.

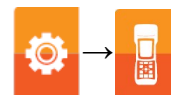
PARAMETER	DESCRIPTION
 Bluetooth	Through this sub menu the user can turn on and off the instrument Bluetooth® wireless communication with a PC or PDA. SEE SECTION 9.3.1.
 Time/Date	This allows the current time and date to be set. The user can select the date and hour format either in EU (European) or USA (American) mode. SEE SECTION 9.3.2.
 Brightness	The display brightness may be increased or decreased by acting on cursor keys. This operation may be performed even when the introductory screen is active. SEE SECTION 9.3.3.
 Buzzer	The instrument is fitted with an internal buzzer which is mainly used to signal any faults and/or alarms. In this submenu you can enable or disable the buzzer or enable it and mute the key tones. SEE SECTION 9.3.4.
 Pump	In this submenu you can access the settings of the fumes suction pump and the peristaltic pump. SEE SECTION 9.3.5.
 CO dilution	The CO sensor is protected by a pump which, in case of need, can inject clean air in the gas path in order to dilute the gas concentration measured by the sensor. This function can be either triggered by the overcoming of a CO concentration threshold which can be set by the user or, in case it is known that the flue gases contain high CO concentration, kept enabled any time, independently of CO concentration. The activation of the dilution pump is shown on the display by the icon " ". <div style="border: 1px solid black; padding: 5px; margin-top: 10px;"> THE MAIN PURPOSE CO AUTO-DILUTION FEATURE IS FOR PROTECTION OF THE CO SENSOR AGAINST OVER-SATURATION. THE ACCURACY AND RESOLUTION OF THE CO MEASUREMENT IS NOT AS GREAT WHEN THIS FEATURE IS ENABLED.</div> SEE SECTION 9.3.8.



PARAMETER	DESCRIPTION
 <p>Micromanometer</p>	<p>Allows to configure the micromanometer input (optional) as P+ or P- port. In case P- is selected, the sign of pressure is inverted. SEE SECTION 9.3.9.</p>
 <p>NDIR bench</p>	<p>Allows to enable (on) or disable (off) the NDIR bench. SEE SECTION 9.3.10.</p>

9.3.1 Configuration → Instrument → Bluetooth®

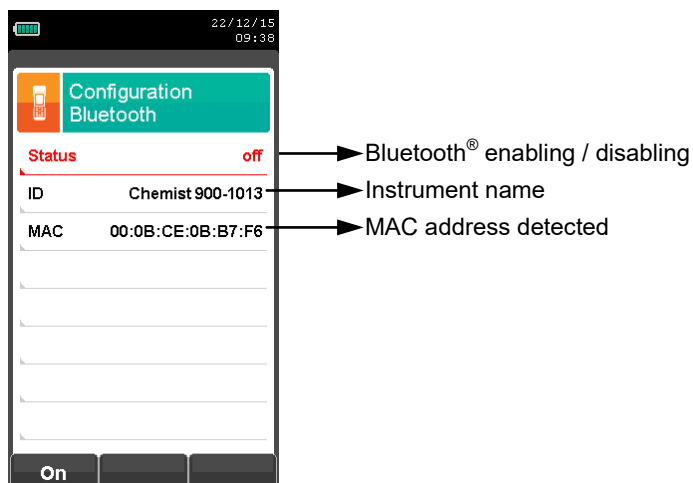

KEY	FUNCTION
	Activate the context keys shown on the display.
	Also activates the context key shown on the display.
	Returns to the previous screen.

CONTEXT KEY	FUNCTION
	Turns on Bluetooth® communication.
	Turns off Bluetooth® communication.

9.3.2 Configuration→Instrument→Time/Date

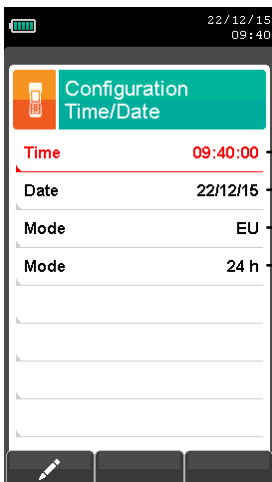





- Time, in the chosen format
- Date, in the chosen format
- Date format: EU (Europe) or USA (America)
- Time format: 24h or 12h

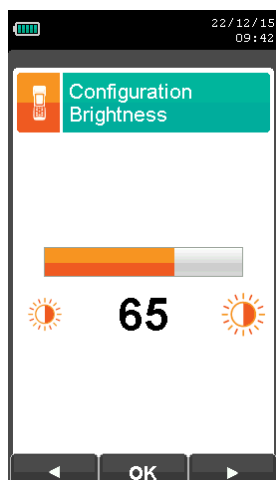

KEY	FUNCTION
	Activate the context keys shown on the display.
	The arrows '▲' and '▼' select each line displayed (the selected line is highlighted in red). When in modify mode, sets the desired value.
	Enters edit mode of the selected element and then confirms the change.
	When pressed in modify mode cancels the selection made, otherwise returns to the previous screen.

CONTEXT KEY	FUNCTION
	Enters edit mode of the selected parameter.
	Confirms the modification.

9.3.3 Configuration→Instrument→Brightness

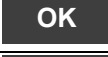

KEY	FUNCTION
	Activate the context keys shown on the display.
	Increases or decreases the brightness of the display.
	Confirms the modification.
	When pressed in modify mode cancels the selection made, otherwise returns to the previous screen.



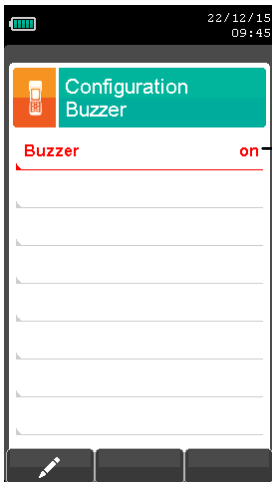

CONTEXT KEY	FUNCTION
	Decreases the brightness of the display.
	Confirms the setting.
	Increases the brightness of the display.



9.3.4 Configuration→Instrument→Buzzer



Available settings:



- on:** the buzzer is enabled (key tones and signalling of faults/alarms are enabled).
- limited:** the buzzer is enabled in a limited mode (key tones are disabled, while signalling of faults/alarms is enabled).
- off:** the buzzer is disabled.



KEY	FUNCTION
	Activate the context keys shown on the display.
	When in modify mode, sets the desired value.
	Enters edit mode of the selected element and then confirms the change.
	When pressed in modify mode cancels the selection made, otherwise returns to the previous screen.

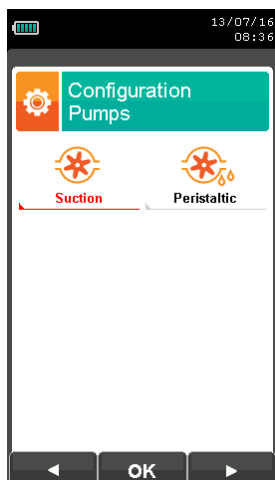

CONTEXT KEY	FUNCTION
	Enters edit mode of the selected parameter.
	Confirms the modification.

9.3.5 Configuration→Instrument→Pumps



KEY	FUNCTION
	Activate the context keys shown on the display.
	Back to the previous screen.

CONTEXT KEY	FUNCTION
	Select the available parameters.
	Enter the selected parameter.
	Select the available parameters.

PARAMETER	DESCRIPTION
 Suction	In this submenu you can turn on and off the gas suction pump. Also, if the pump is on, it is possible to view and modify the pump flow measured in liters per minute. It will not be possible to turn off the pump if the auto-zero cycle is currently running. SEE SECTION 9.3.6.
 Peristaltic	In this submenu it is possible to set the off interval of the peristaltic pump. SEE SECTION 9.3.7.

9.3.6 Configuration → Instrument → Pumps → Suction

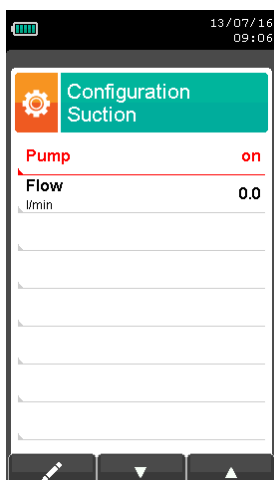

- ▶ Available options: on (pump switched on) or off (pump switched off).
- ▶ Display of the pump's flow, expressed in Litres per minute. The data is modifiable in the range (1.4 .. 2.2).

KEY	FUNCTION
	Activate the context keys shown on the display.
	When in modify mode, sets the desired value.
	Enters edit mode of the selected element and then confirms the change.
	When pressed in modify mode cancels the selection made, otherwise returns to the previous screen.

CONTEXT KEY	FUNCTION
	Activates edit mode: it is possible to turn on / off the fumes suction pump.
	Confirm the option selected.
	Holding down the key, decreases the pump flow.
	Holding down the key, increases the pump flow.

9.3.7 Configuration→Instrument→Pumps→Peristaltic



Power-off time configurable in the range 30 .. 3600 seconds.

KEY	FUNCTION
	Activate the context keys shown on the display.
	When in modify mode, sets the desired value.
	Enters edit mode of the selected element and then confirms the change.
	When pressed in modify mode cancels the selection made, otherwise returns to the previous screen.



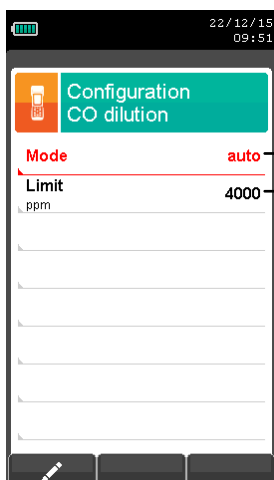

CONTEXT KEY	FUNCTION
	Edit mode: it is possible to set the range of time while the peristaltic pump remains disabled.
	Confirms the modification.



9.3.8 Configuration → Instrument → CO dilution



Available settings: auto, on or off.
 Threshold that activates the dilution pump (available only if the "Mode" parameter is set to "auto").

WARNING
 The activation of the dilution pump is shown on the display by the icon "  ".

KEY	FUNCTION
	Activate the context keys shown on the display.
	Select each line displayed (the line selected is red). In edit mode, it sets the desired value.
	Enters edit mode of the selected element and then confirms the change.
	When pressed in modify mode cancels the selection made, otherwise returns to the previous screen.

CONTEXT KEY	FUNCTION
	Enters edit mode of the selected parameter.
	Confirms the modification.

9.3.9 Configuration → Instrument → Micromanometer

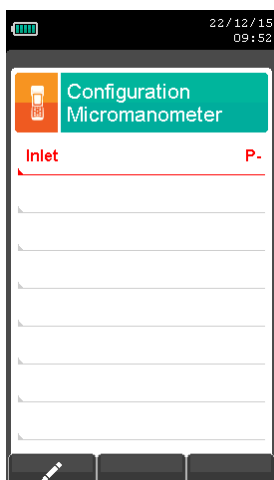
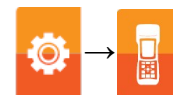

Sets the input used for the test: P+ or P-

KEY	FUNCTION
	Activate the context keys shown on the display.
	In edit mode, it sets the desired input.
	Enters edit mode of the selected element and then confirms the change.
	When pressed in modify mode cancels the selection made, otherwise returns to the previous screen.

CONTEXT KEY	FUNCTION
	Enters edit mode of the selected parameter.
	Confirms the modification.

9.3.10 Configuration→Instrument→NDIR bench

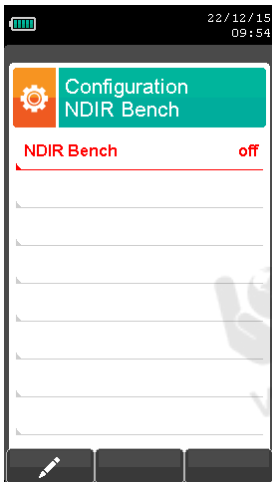

Available settings: **on**: NDIR bench is enabled - **off**: NDIR bench is disabled.

WARNING:
In order to make effective the new configuration, please turn the instrument off and then on again.

KEY	FUNCTION
	Activate the context keys shown on the display.
	In edit mode, it sets the desired input.
	Enters edit mode of the selected element and then confirms the change.
	When pressed in modify mode cancels the selection made, otherwise returns to the previous screen.

CONTEXT KEY	FUNCTION
	Enters edit mode of the selected parameter.
	Confirms the modification.

9.4 Configuration → Operator

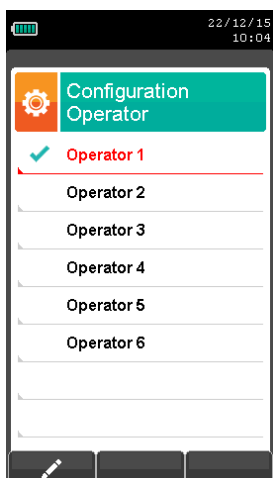

KEY	FUNCTION
	Activate the context keys shown on the display.
	In "edit text": Moves the cursor on the box corresponding to the letter or number required to form the word.
	In "Operator Configuration": Scrolls through the available operators.
	In "edit text": Confirms text input. In "Operator Configuration": selects the operator who will carry out the analysis; the operator is highlighted with the symbol "✓".
	Returns to the previous screen. In "edit text" mode returns to the previous screen without saving the changes.

CONTEXT KEY	FUNCTION
	Enters edit mode of the selected line: it is possible to enter the name of the operator (24 characters available).
	Confirms the selected letter or digit.
	Cancel the letter or digit before the cursor.
	Cycles through uppercase, lowercase, symbols and special characters.

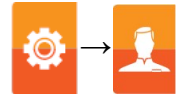

Example:

1. Edit text

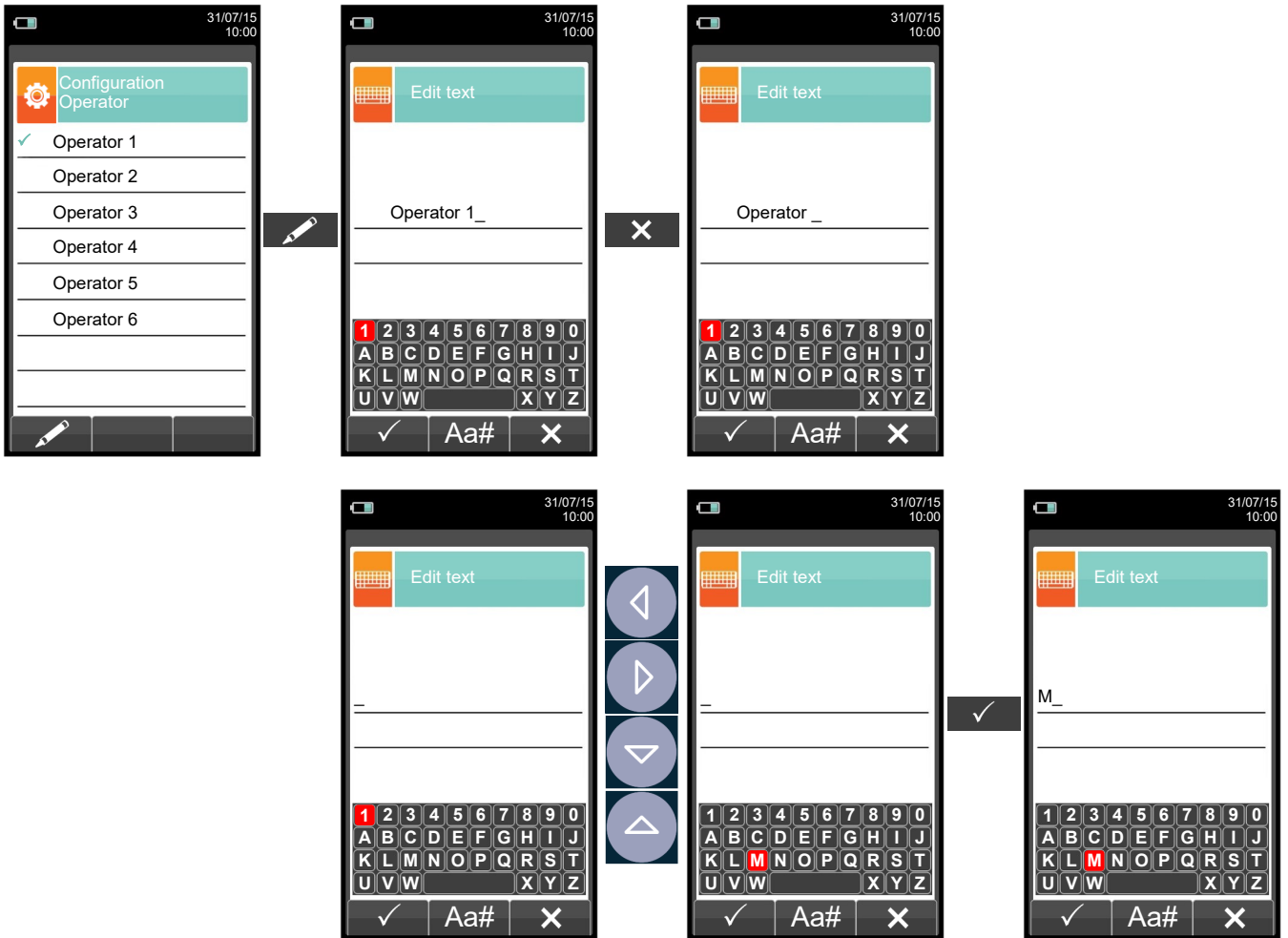

2. Select the operator who will carry out the analysis

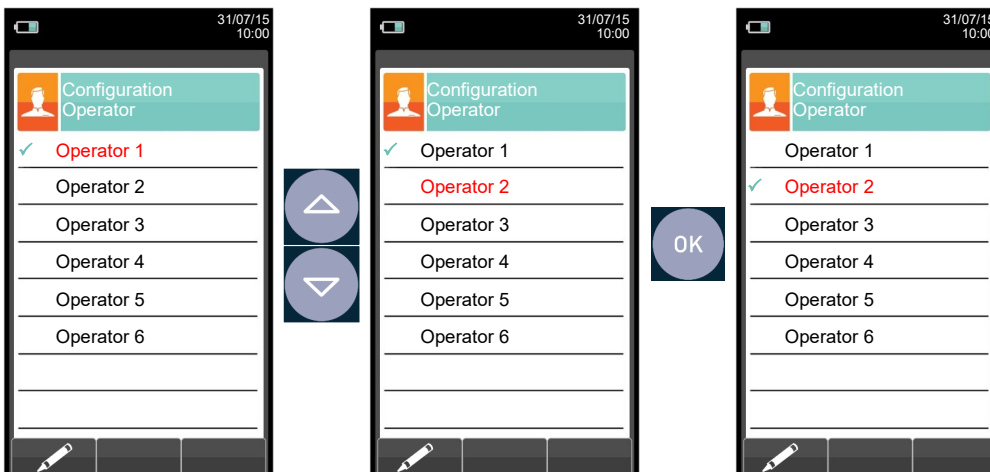

9.5 Configuration → Alarms

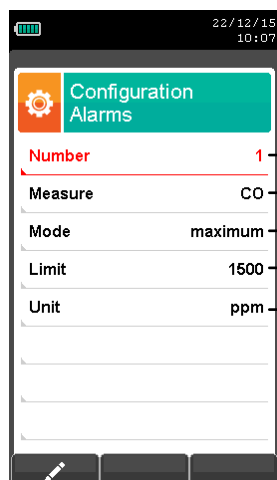

- Number of the alarm set
- Monitored parameter: O₂ - CO - NO - NO₂ - P diff - Plow - P ext - T1 - T2
- Type of alarm set: maximum - minimum - off
- Threshold setting for the alarm: ±999999.999
- Measurement unit for the threshold set: ppm, mg/m³, mg/kWh, g/GJ, g/m³, g/kWh, %, ng/J

KEY	FUNCTION
	Activate the context keys shown on the display.
	Keys '▲' and '▼' select any line shown on the display (the selected line is displayed in red). When in modify mode, sets the desired value.
	Enters the modify mode for the selected parameter, then confirms the modification.
	When pressed in modify mode cancels the selection made, otherwise returns to the previous screen.

CONTEXT KEY	FUNCTION
	Enters the modify menu for the selected parameter.
	Confirms the modification.

9.6 Configuration → Information

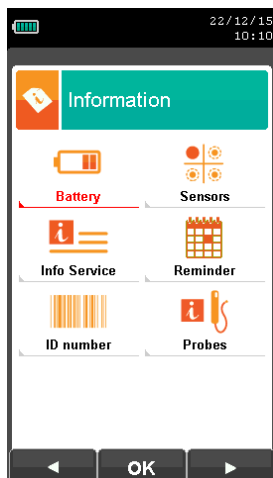



KEY	FUNCTION
	Activate the context keys shown on the display.
	Returns to the previous screen.

CONTEXT KEY	FUNCTION
	Selects the available parameters.
	Enters in the selected parameter setting.
	Selects the available parameters.

PARAMETER	DESCRIPTION
 Battery	Displays the current battery power status in percentage from 0 to 100%, both in text and graphically. SEE SECTION 9.6.1.
 Sensors	Allows to check which sensors are installed on the instrument, and in which position they are installed. The instrument automatically detects whether a sensor has been either added or removed. The screen page allows whether to accept the new configuration or ignore the change performed. SEE SECTION 9.6.2.
 Infoservice	This submenu contains details regarding the nearest Service Center to be contacted in the event of instrument fault or ordinary maintenance. The instrument model, serial number and firmware version are also displayed, thus allowing for a quick product identification. SEE SECTION 9.6.3.
 Reminder	In this menu the user can see the reminder of the instrument annual calibration that was entered in the factory or in the service center. The menu is protected by the following password: " 2908 ". SEE SECTION 9.6.4.
 ID number	Not available.
 Probes	Displays useful information about the probe connected to the serial cable shown in 13 in section 5.0 'Description of Components' . SEE SECTION 9.6.5.

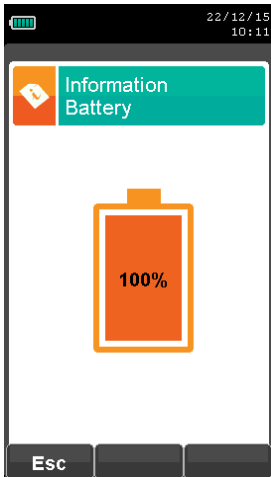
9.6.1 Configuration→Information→Battery



KEY	FUNCTION
	Activate the context keys shown on the display.
	Returns to the previous screen.

CONTEXT KEY	FUNCTION
	Returns to the previous screen.

9.6.2 Configuration→Information→Sensors

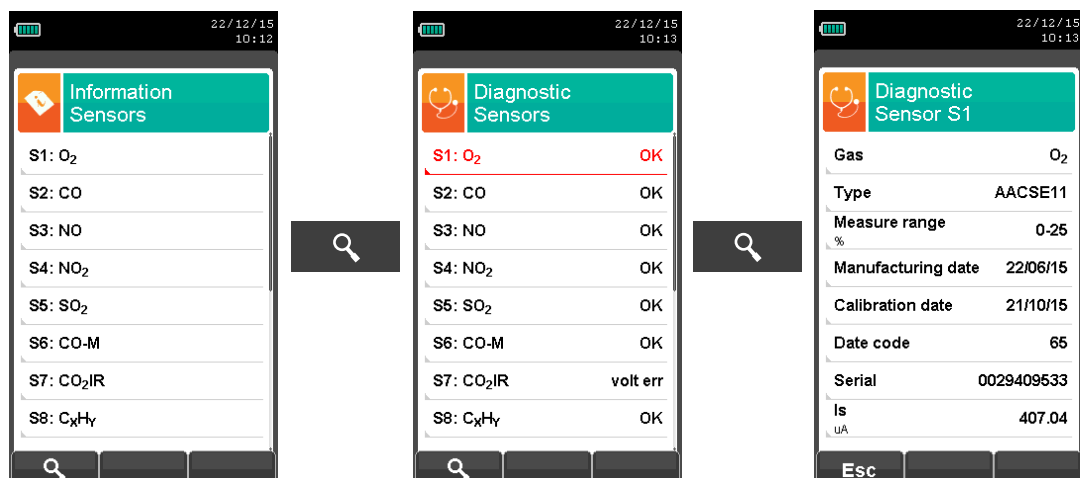

For further information see [section 9.7](#).

KEY	FUNCTION
	Activate the context keys shown on the display.
	Returns to the previous screen.

CONTEXT KEY	FUNCTION
	Displays the details of the main features of the sensors installed.
	Returns to the previous screen.

This screen displays, for each position, the following messages:

MESSAGE	DESCRIPTION
OK	Sensor configured OK (normal operation).
-----	Sensor is not communicating or has been removed. For sensors in positions 10, 11 and 12: NDIR bench is not installed or has been disabled .
<i>The name of the detected gas is flashing</i>	New sensor detected.
Pos err	Detected sensor in wrong position.
Volt err	Detected voltage is out of the normal operating range; repeat the autozero.
Curr err	Detected current is out of the normal operating range; repeat the autozero.
Err autozero	NDIR bench autozero failed.

Error messages displayed:

MESSAGE	DESCRIPTION
Cal err	Calibration error.
Data err	Sensor not recognized.
No cal	Sensor not calibrated.

9.6.3 Configuration → Information → InfoService

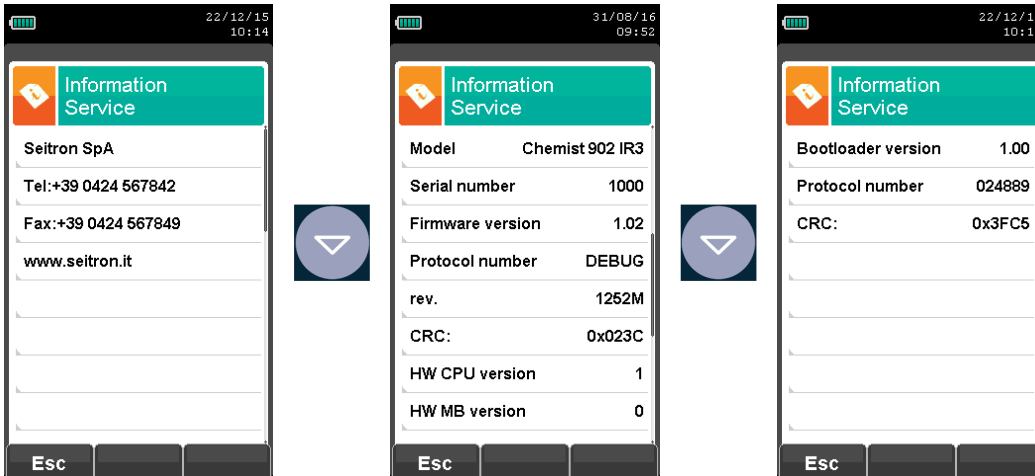
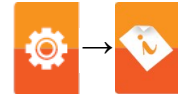

KEY	FUNCTION
	Activate the context keys shown on the display.
	Returns to the previous screen.

CONTEXT KEY	FUNCTION
	Returns to the previous screen.

9.6.4 Configuration→Information→Reminder

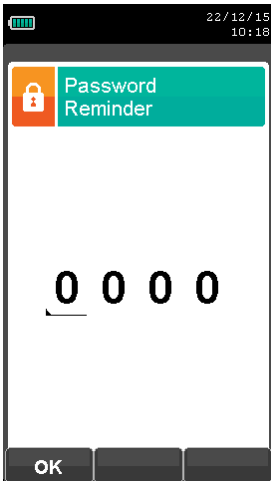
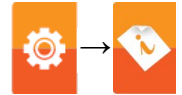

KEY	FUNCTION
	Activate the context keys shown on the display.
	Sets the password to access the remainder menu. The password is: 2908.
	Returns to the previous screen.

CONTEXT KEY	FUNCTION
	Shows details about the main features of the sensors installed.
	Returns to the previous screen.
	Shows all information relevant to service center.
	Temporarily ignores the message. At next turn-on of the instrument the reminder will be shown again.
	Ignores the message permanently.

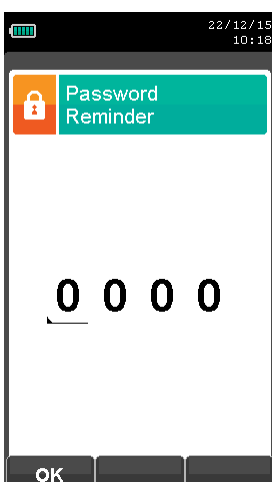



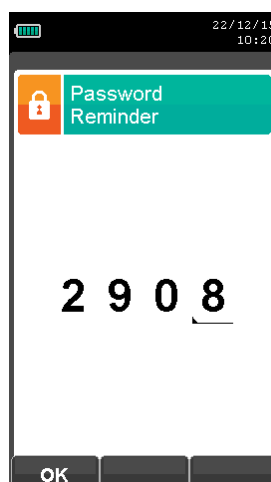

 Enter the password
 for the reminder
 menu ' 2908 '

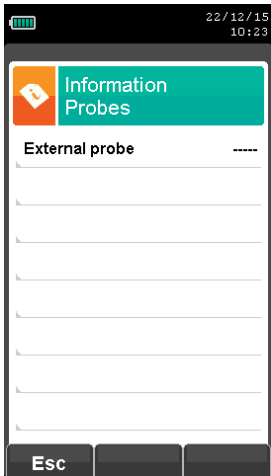

9.6.5 Configuration→Information→Probes



KEY	FUNCTION
	Activate the context keys shown on the display.
	Returns to the previous screen.

CONTEXT KEY	FUNCTION
	Returns to the previous screen.

9.7 Configuration → Diagnostic

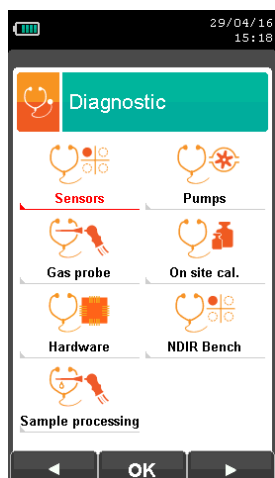

KEY	FUNCTION
	Activate the context keys shown on the display.
	Returns to the previous screen.

CONTEXT KEY	FUNCTION
	Selects the available parameters.
	Enters in the selected parameter setting.
	Selects the available parameters.

PARAMETER	DESCRIPTION
<p>Sensors</p>	<p>Displays information on the state and calibration of the electrochemical sensors:</p> <p>Ok No problem detected absent The sensor was not detected err data Memory data error of the sensor unknown It is necessary to update the FW of the device err pos The sensor has been installed in the wrong position err cal Calibration error (sensor not calibrated) err curr Currents outside the range err cfg Do not use this sensor as it has not been accepted on the screen "types of sensors".</p> <p>Also, from this screen the user can access the identification data of the sensor: type, serial number, date of manufacture and calibration. There are also the measured currents; in this way it is possible to perform a quick diagnosis in the event of a malfunction. SEE SECTION 9.8.</p>
<p>Pumps</p>	<p>The user can access to the management of the flue gas sampling pump and the peristaltic pump. SEE SECTION 9.9.</p>
<p>Gas probes</p>	<p>Allows to check the tightness of the flue sampling probe. SEE SECTION 9.10.</p>
<p>On site cal.</p>	<p>It is possible to make a recalibration of the instrument gas sensors with suitable known concentration gas cylinders. For the sensors sensible to other gases, called interfering gases (for example NH₃, H₂, H₂S, SO₂, ...) it is possible to perform the on site calibration also for the relevant interfering gases. The sensors recalibration procedure is protected with a password: inquire Seitron Customer Service in order to obtain it. SEE SECTION 9.11.</p>
<p>Hardware</p>	<p>At instrument turn on the firmware performs a full check on the physical efficiency of all types of HW memories installed on the instrument, as well as on the integrity of the data stored into them. Any issue is displayed in the screen 'Memories Diagnostics'. Should this happen it is advisable to turn the instrument off and then on again. In case the problem is permanent or frequently recurring, the user should contact the Service Center reporting the error code shown by the instrument. SEE SECTION 9.12.</p>
<p>NDIR Bench</p>	<p>The user can check the status of the infrared bench NDIR. SEE SECTION 9.13.</p>
<p>Sample processing</p>	<p>The user can check the status of the heated line (heated tube, heated head and Peltier cell unit). SEE SECTION 9.14.</p>

9.8 Configuration → Diagnostic → Sensors

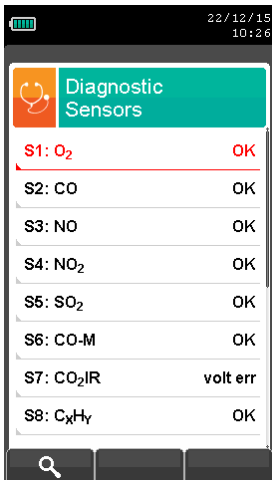
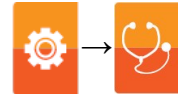

KEY	FUNCTION
	Activate the context keys shown on the display.
	Selects the fuel.
	Activates the context keys located in the left side of the display.
	Returns to the previous screen.



CONTEXT KEY	FUNCTION
	Displays the details of the selected sensor (see example below).
	Returns to the previous screen.

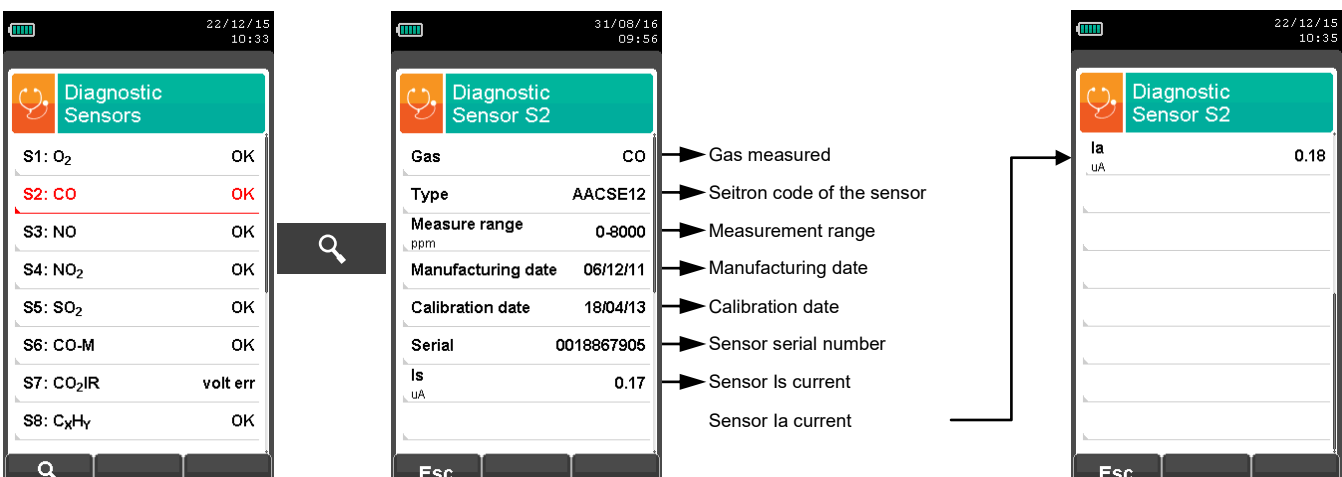

Example:

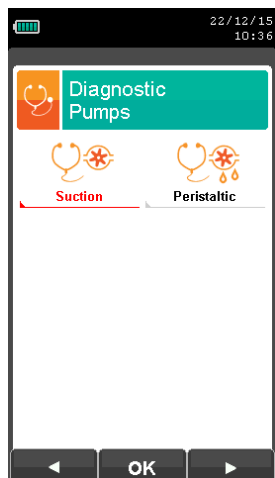



9.9 Configuration → Diagnostic → Pump



KEY	FUNCTION
	Activate the context keys shown on the display.
	Returns to the previous screen.

CONTEXT KEY	FUNCTION
	Selects the available parameters.
	Enters in the selected parameter setting.
	Selects the available parameters.

PARAMETER	DESCRIPTION
 <p>Suction</p>	In this submenu the user can temporarily turn the gas suction pump on or off. Also, it is possible to view the actual flow rate of the pump in liters per minute. It will not be possible to turn off the pump during an autozero cycle. SEE SECTION 9.9.1.
 <p>Peristaltic</p>	In this submenu the remaining useful lifetime of the tube of the peristaltic pump is displayed. After replacing the tube of the peristaltic pump, perform a reset to restart the countdown of the hours of use of the tube. SEE SECTION 9.9.2.

9.9.1 Configuration→Diagnostic→Suction

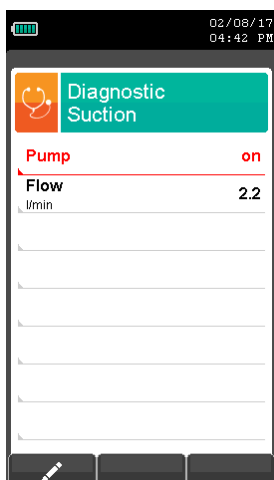







KEY	FUNCTION
	Activate the context keys shown on the display.
	Selects the fuel.
	Activates the context keys located in the left side of the display.
	Returns to the previous screen.

CONTEXT KEY	FUNCTION
	Enters edit mode: it is possible to turn the gas suction pump on and off.
	Confirms the modification.

9.9.2 Configuration → Diagnostic → Peristaltic



KEY	FUNCTION
	Activate the context keys shown on the display.
	Enters in the modification mode then confirms the changes made.
	Activate the context keys shown on the display.

CONTEXT KEY	FUNCTION
	Enters the modify mode: you can reset the timer of the time left for replacing the tube of the peristaltic pump.
	Resets the timer.
	Cancels and returns to the previous screen.

9.10 Configuration → Diagnostic → Gas probe

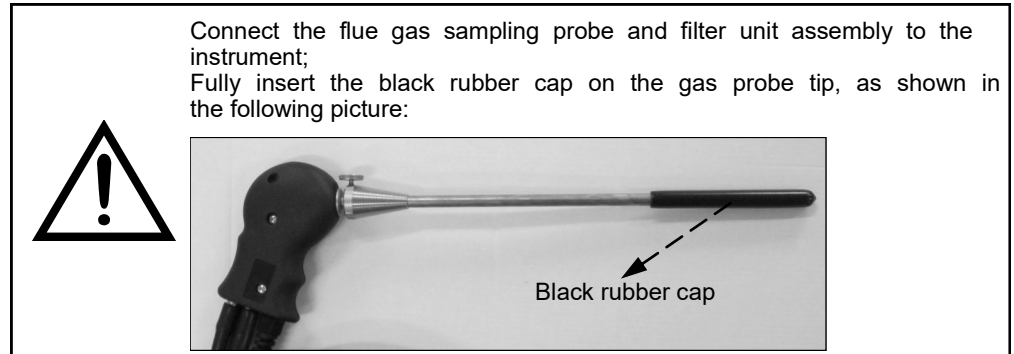

KEY	FUNCTION
	Activate the context keys shown on the display.
	Activates the context key located in the left side of the display.
	Returns to the previous screen.

CONTEXT KEY	FUNCTION
	Starts the test to check the tightness of the gas sampling probe.
	Starts the test of the gas sampling probe.

Tightness test of the probe.

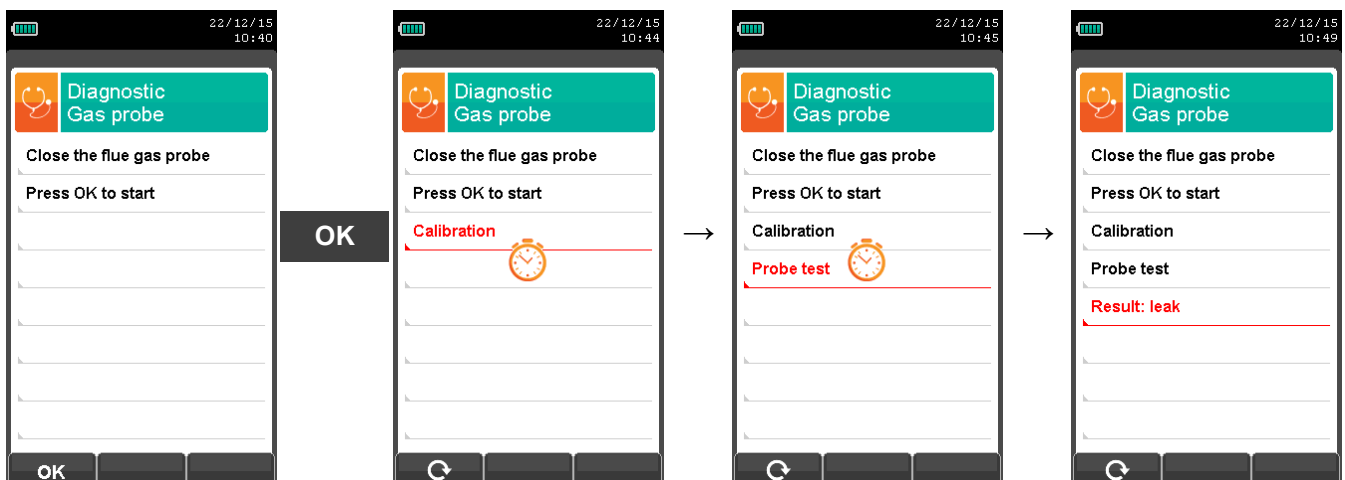







Results:

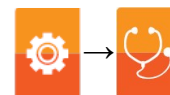



Tightness: The system is tight.

Error: Make sure that the probe is connected to the input P-, check the seals of the pneumatic connections and/or the seal of the condensation trap and check that the test cap is correctly inserted on the tip of the probe. **WARNING: a damaged probe tip may impair the test.**

9.11 Configuration → Diagnostic → On site cal.



KEY	FUNCTION
	Activate the context keys shown on the display.
	Sets the password.
	Selects line; the selected line is displayed in red. In modification sets the value or the desired mode.
	Activates the context key located in the left side of the display.
	Returns to the previous screen. When in modify mode cancels the modification just made.

CONTEXT KEY	FUNCTION
	Once password is entered, gives access to the 'On site calibration' menu.
	Shows details for the selected sensor.
	Zeroes the timer.
	Enters the modification mode for the selected parameter.

9.11.1 Calibration procedure



In order to perform the calibration, the following tools are needed:

- Calibration gas cylinder suitable for the sensor with known gas concentration, complete with a pressure regulator.

WARNING!

For the oxygen sensor on site calibration, the zero value calibration must be carried out with nitrogen or any other gas mixture which DOES NOT contain oxygen.

- Flow meter.
- Hose with ' T ' shaped junction, in order to connect the cylinder to the instrument and the flow meter.

1. Start the instrument

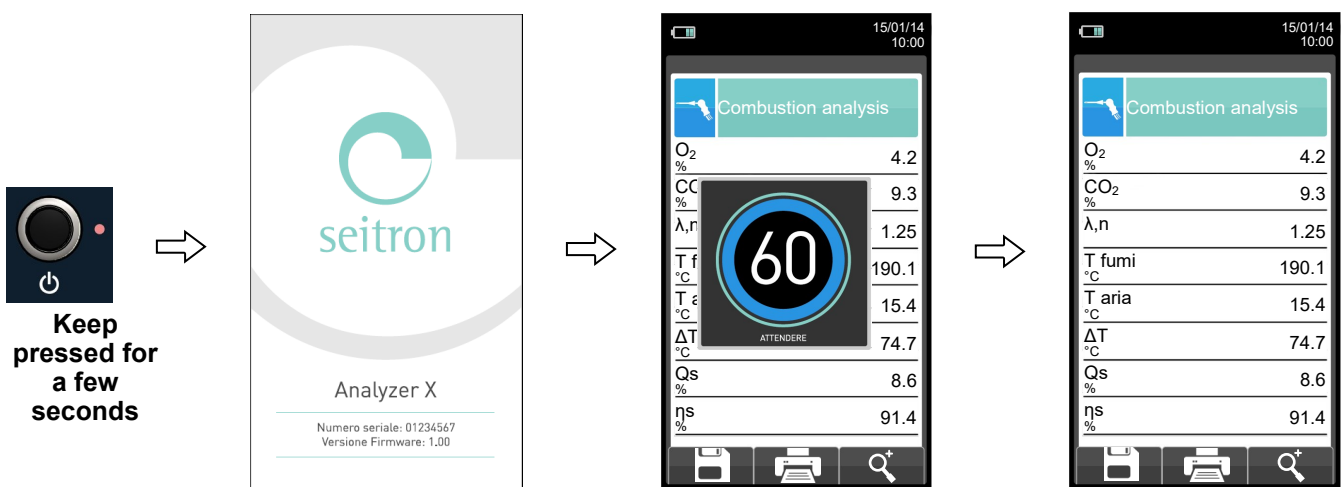

WARNING

- Make sure autozero is execute in clean air and terminates correctly.
- Do not connect the gas probe to the instrument.
- Check the battery charge level or connect the power adapter to avoid data loss during recalibration.

2. Once autozero is completed press the key and select the diagnostic icon.

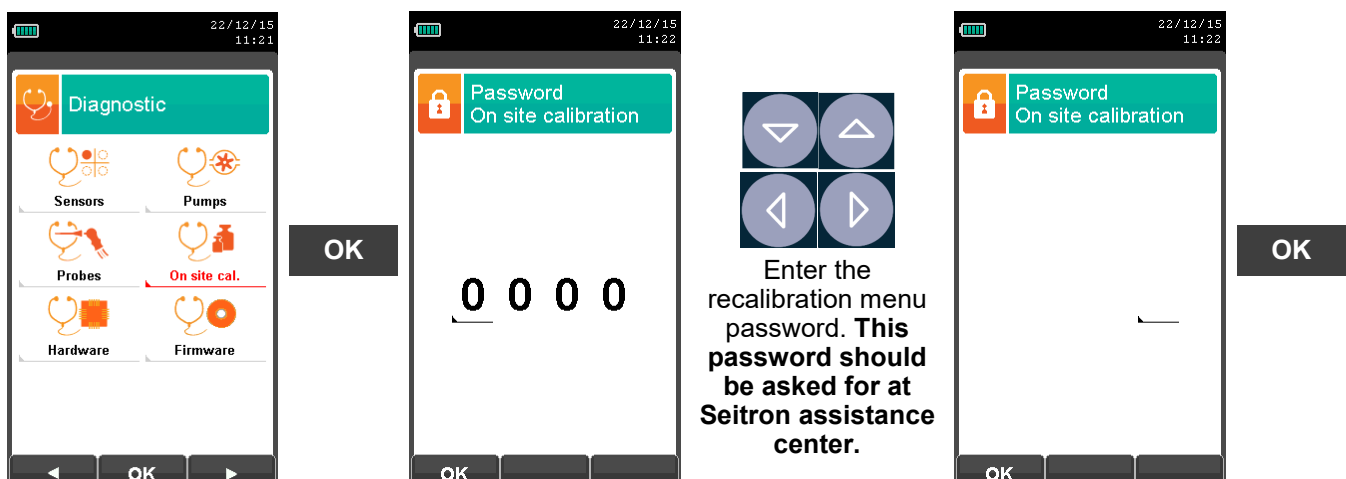

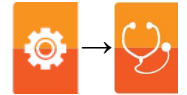

3. Once in the 'On site calibration' menu, the list of the installed sensors for which the recalibration is available is shown.

By selecting one sensor, in the recalibration screen all information related to the last performed calibration is shown.

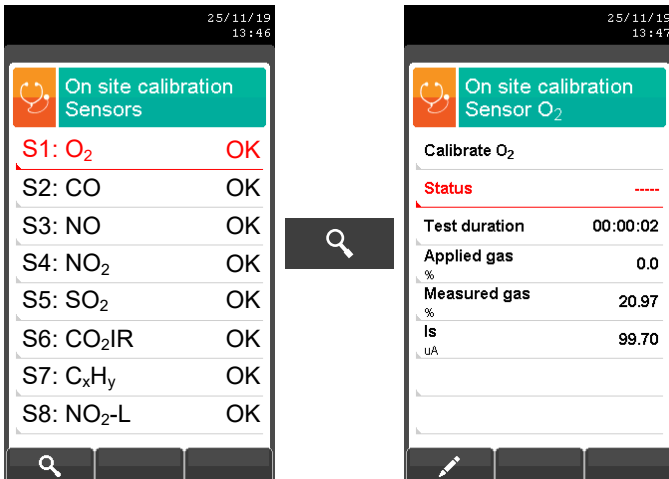

Calibrate: saves new calibration

Status: not active: returns to the factory calibration
active: returns to the last calibration made by the user
----: no 'on site calibration' has been previously stored

Test duration: timer

Applied gas: enters the concentration of the applied calibration gas

Measured gas: measures the concentration of the applied gas

Is: 'Is' current from the sensor

Ia: 'Ia' current from the sensor (CO only)

CHOOSE THE SENSOR TO BE CALIBRATED AND DO AS FOLLOWS

4. Connect the instrument to the gas cylinder suitable for the selected sensor, with known gas concentration, as shown in the following diagram.



WARNING!
Adequate ventilation must be provided when working with toxic gases, particularly the flow meter and instrument outputs must be evacuated by a ventilation system.

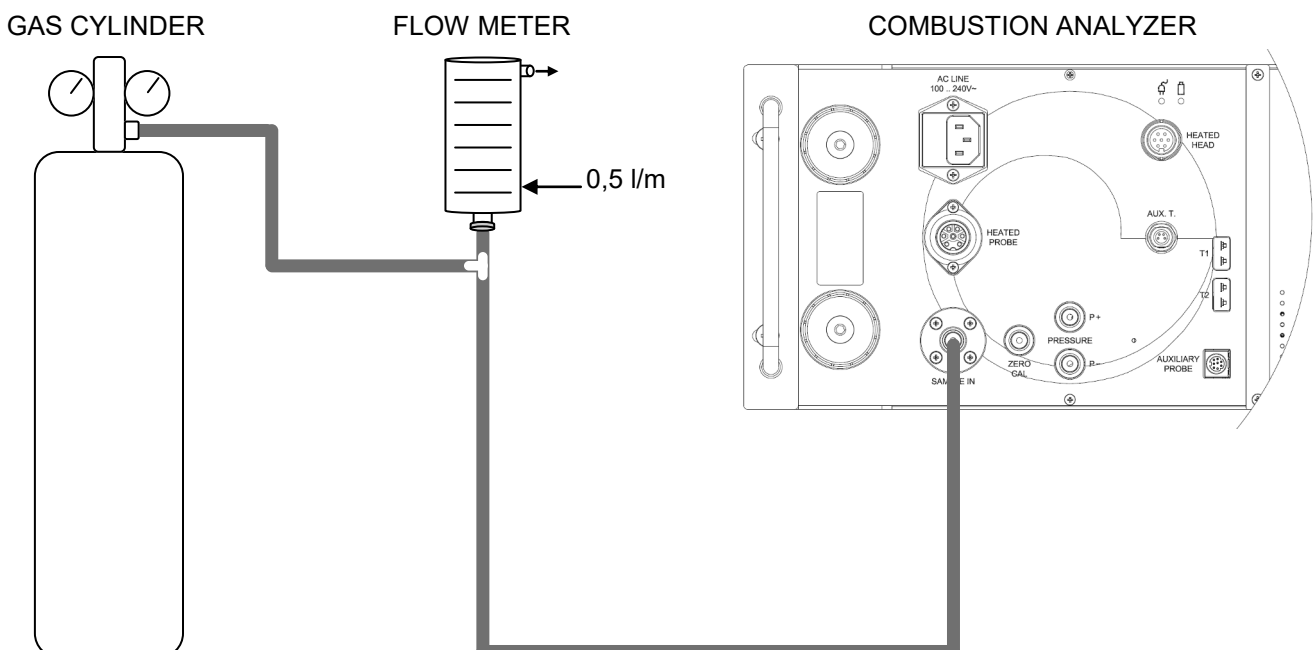

OXYGEN SENSOR (O₂) CALIBRATION DETAIL.

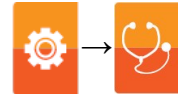

- The calibration will be possible only when the status is set to '----' (cells which never had an on-site calibration) or it is necessary to set the state to 'not active' (see example).

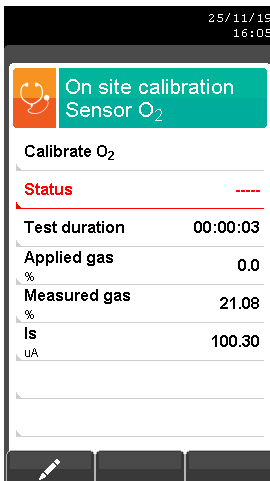

OR

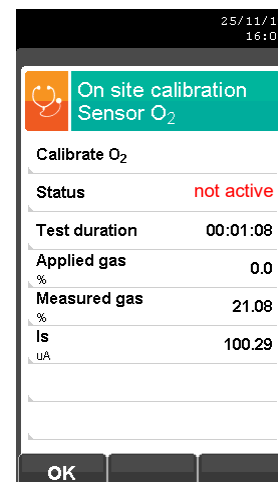
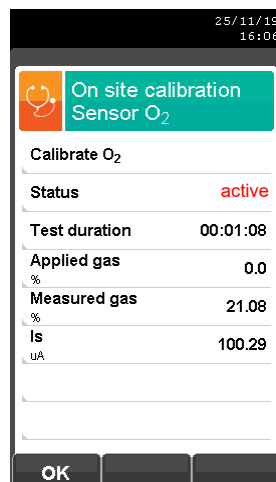
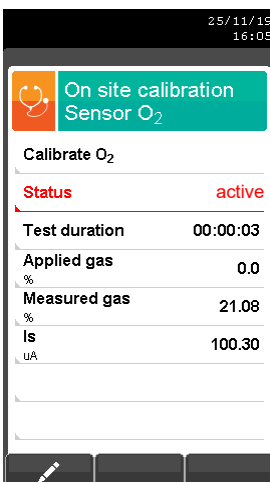

- Apply gas to the instrument** and adjust the output pressure of the gas from the cylinder so that the flow meter indicates a minimum flow of 0.5 l/m: this guarantees that the instrument is taking the exact amount of gas required by the internal pump.
- The instrument measures the concentration of gas applied; **wait at least 3 minutes to allow the reading to stabilize**. The reading is shown in line 'Gas measured'.

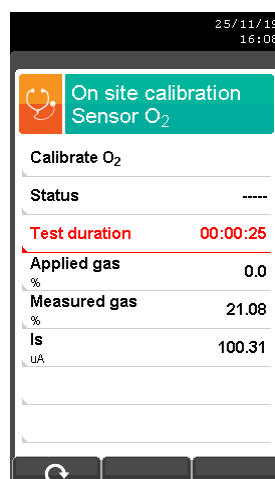
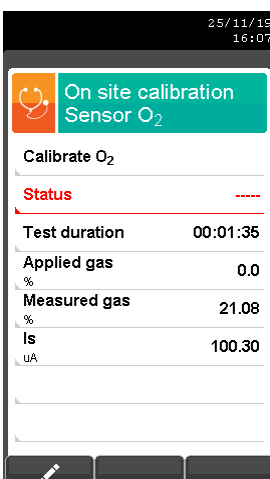

Zeroes the timer - helps to keep under control the time elapsing during the stabilization phase.

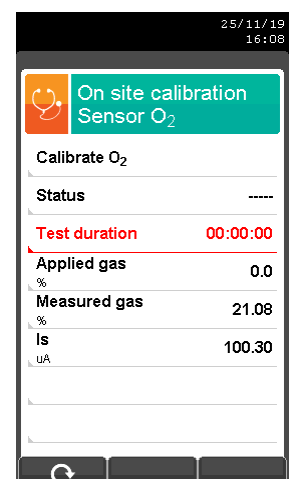

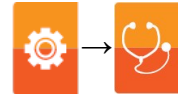

- When the stabilization time is over, select the 'Calibration' row and store the new calibration.

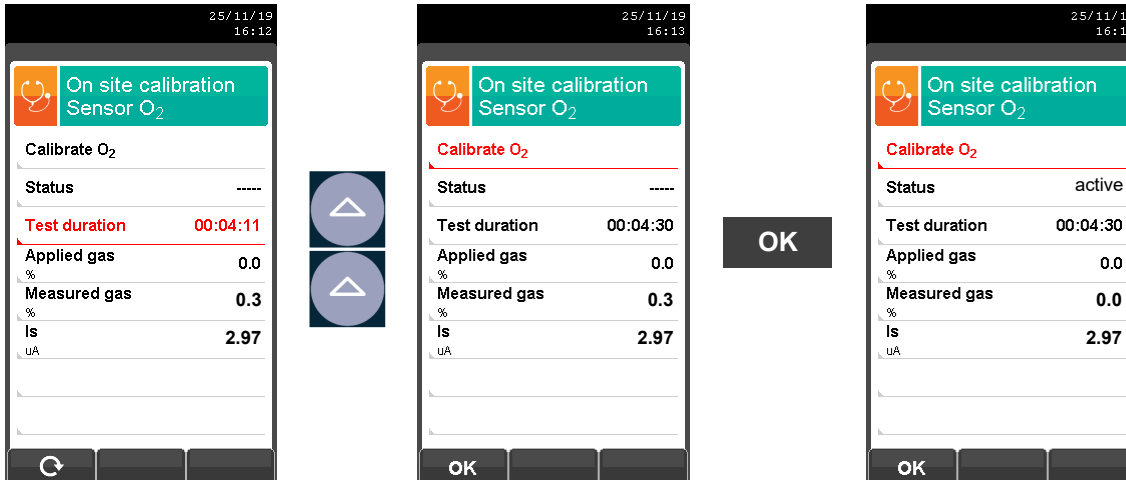

Once the new calibration has been stored, the possible temporary messages which can be seen on the row 'status' are the following:

saving: the instrument is saving the performed calibration

error: the sensor has NOT been recalibrated for any of the following reasons:

- The calibration gas cannot properly reach the instrument.
- The user didn't allow for the stabilization time to properly elapse.
- The sensor could be damaged or exhausted and must therefore be replaced.



WARNING

- At any time the user can restore the factory calibration in the instrument by setting the 'Status' line on 'not active'.
- The recommended stabilization time for the on-site calibration of the sensors is 3 minutes. This time can be up to 5 minutes for NO₂ and SO₂ sensors.

TOXIC GASES SENSOR CALIBRATION DETAIL (EXAMPLE REFERRED TO CO).

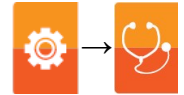

- The calibration will be possible only when the status is set to '----' (cells which never had an on-site calibration) or it is necessary to set the state to 'inactive' (see example).

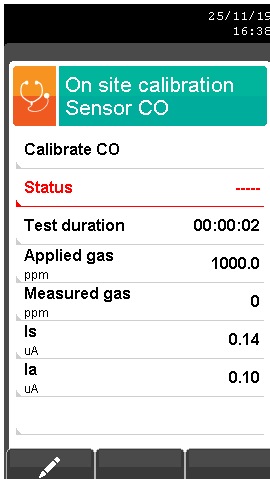

OR

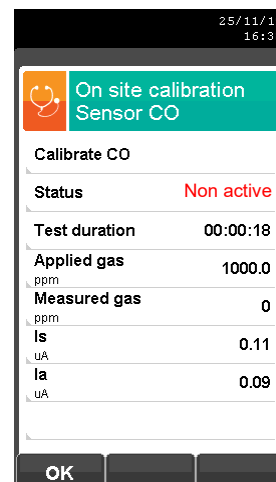
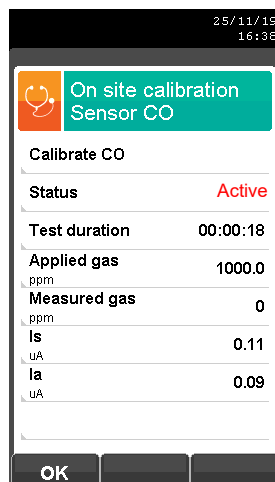
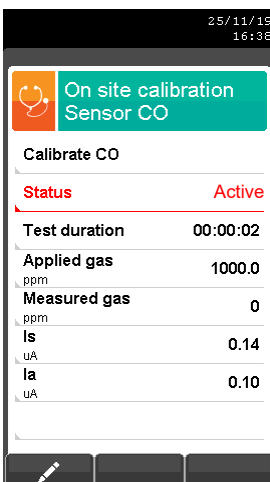

- Enter the concentration value of the applied gas.

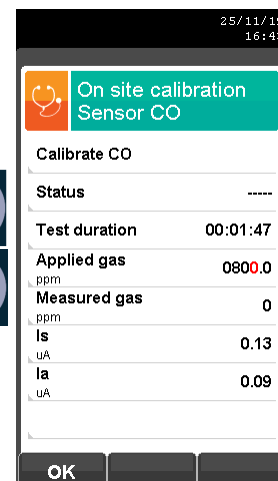
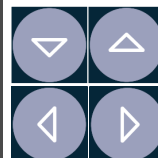
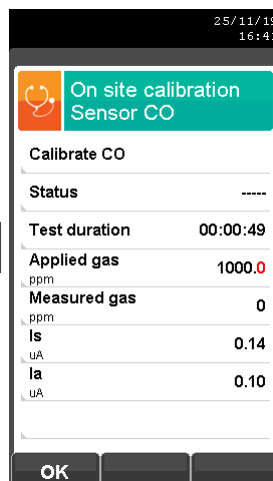
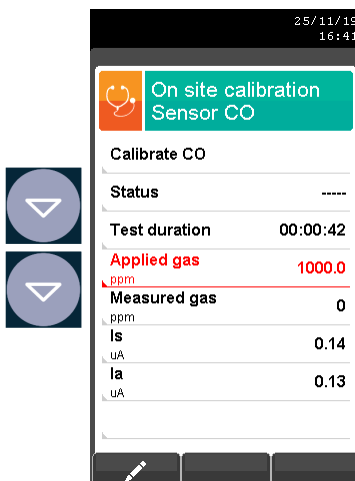

- Apply gas to the instrument and adjust the output pressure of the gas from the cylinder so that the flow meter indicates a minimum flow of 0.5 l/m: this guarantees that the instrument is taking the exact amount of gas required by the internal pump.

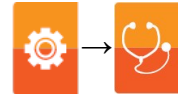

- The instrument measures the concentration of gas applied; **wait at least 3 minutes to allow the reading to stabilize**. The reading is shown in line 'Gas measured'.

Zeroes the timer - helps to keep under control the time elapsing during the stabilization phase.

- When the stabilization time is over, select the 'Calibration' row and store the new calibration.

OK

Once the new calibration has been stored, the possible temporary messages which can be seen on the row 'status' are the following:

saving: the instrument is saving the performed calibration

error: the sensor has NOT been recalibrated for any of the following reasons:

- The calibration gas cannot properly reach the instrument.
- Concentration for the calibration gas has not been set in the relevant line 'Applied gas'.
- The user didn't allow for the stabilization time to properly elapse.
- The sensor could be damaged or exhausted and must therefore be replaced.



WARNING

- At any time the user can restore the factory calibration in the instrument by setting the 'Status' line on 'not active'.
- The recommended stabilization time for the on-site calibration of the sensors is 3 minutes. This time can be up to 5 minutes for NO₂ and SO₂ sensors.

TOXIC GASES SENSOR CALIBRATION DETAIL WITH INTERFERING GASES



The toxic gases sensors with interfering gases are these sensors sensible to other gases. The on site calibration for these sensors also allows to calibrate the interfering gases.

The on site calibration procedure for these sensors is the same described in the previous pages regarding the toxic gases sensors and it can be performed for all the gases which interferes with the sensor itself.

On the following is described the mode to access the interfering gases with the sensor which must be calibrated on site (example referred to NH₃ sensor).

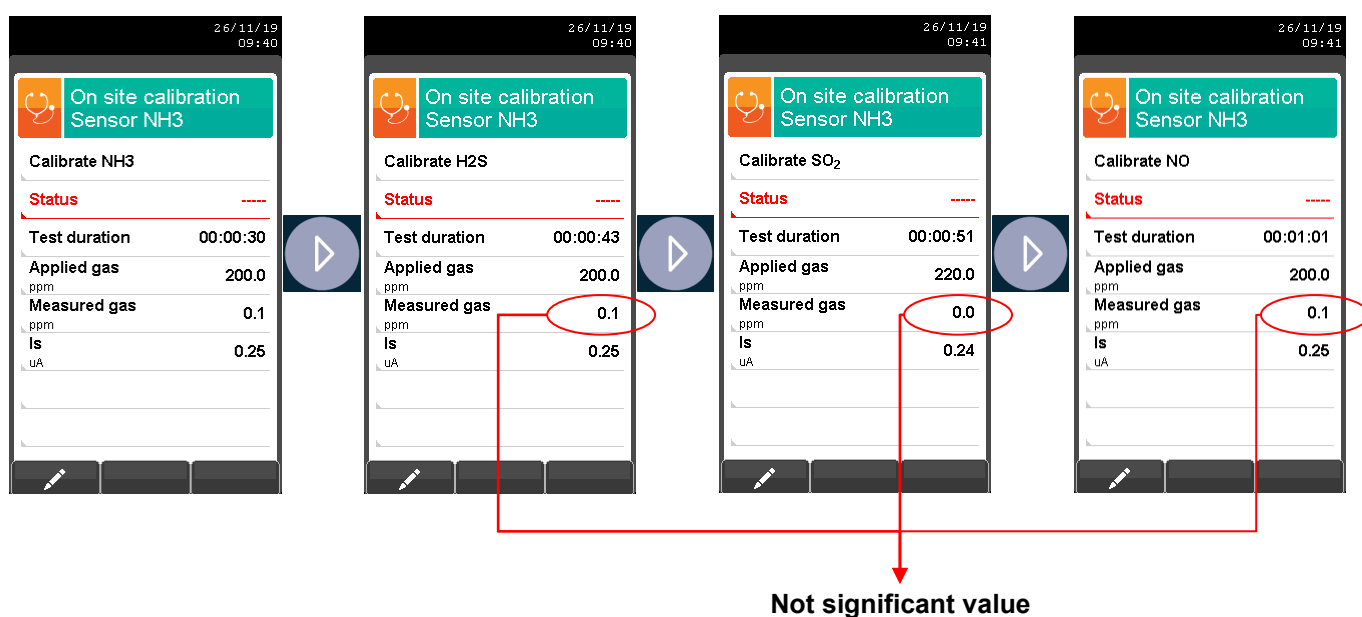

SENSOR	INTERFERING GASES		
NH ₃	H ₂ S	SO ₂	NO
SO ₂	CO	NO	NO ₂
H ₂ S	SO ₂	NO	NO ₂
H ₂	CO	NO	NO ₂

Tab. 1: Interfering gases table.

WARNING
The recommended stabilization time for the on-site calibration of these sensors is 5 minutes.

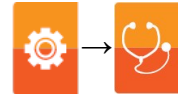

WARNING
During analysis, the influence of interfering gases is compensated only if the correspondent sensor is installed.



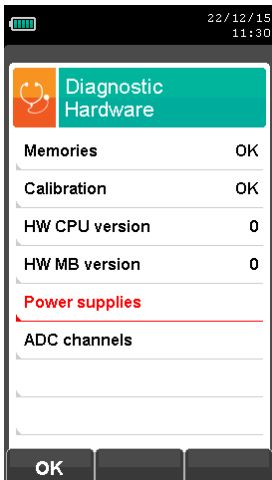

9.12 Configuration → Diagnostic → Hardware



- State of memory
- State of calibration
- Version of CPU board
- Version of motherboard
- Main power supplies
- ADC converter input signals





KEY	FUNCTION
	Activate the context keys shown on the display.
	Returns to the previous screen.

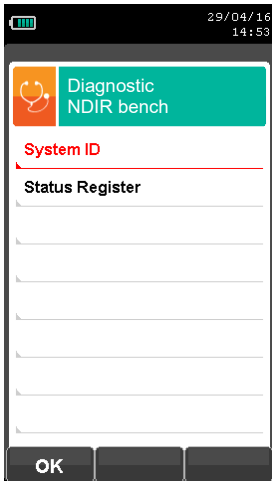

CONTEXT KEY	FUNCTION
	Returns to the previous screen.
	Shows values in mV
	Shows values in bits

9.13 Configuration → Diagnostic → NDIR bench







→ NDIR bench identification data.
 → NDIR bench information about operational status.

KEY	FUNCTION
	Activate the context keys shown on the display.
	Selects line; the selected line is displayed in red.
	Activates the context key located in the left side of the display.
	Returns to the previous screen.

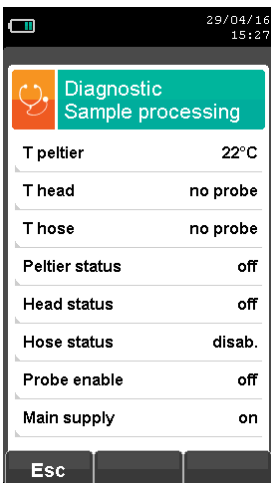
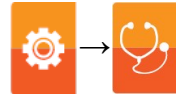
CONTEXT KEY	FUNCTION
	Enters in the selected data setting.
	Returns to the previous screen.

9.14 Configuration → Diagnostic → Sample processing



KEY	FUNCTION
	Activate the context keys shown on the display.
	Activates the context key located in the left side of the display.
	Returns to the previous screen.

CONTEXT KEY	FUNCTION
	Returns to the previous screen.

9.15 Configuration→Language

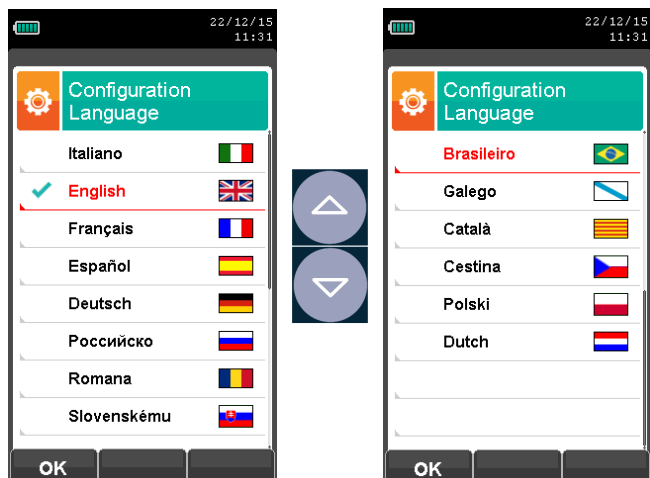





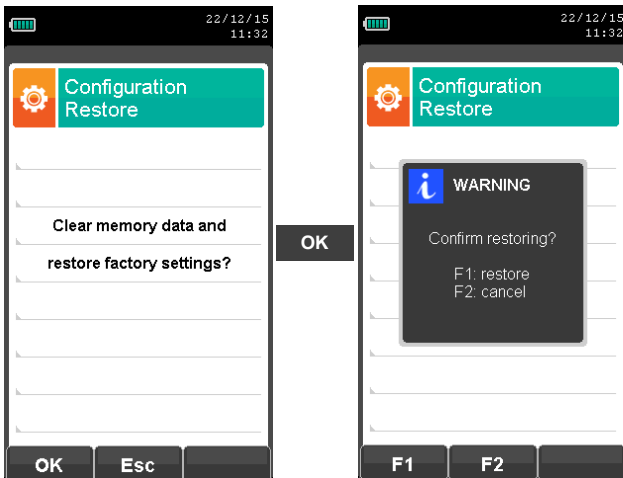

KEY	FUNCTION
	Activate the context keys shown on the display.
	Scrolls through the available languages.
	Sets the selected language.
	Returns to the previous screen.

CONTEXT KEY	FUNCTION
	Sets the selected language.

9.16 Configuration→Restore



KEY	FUNCTION
	Activate the context keys shown on the display.
	Starts the factory values reset phase.
	Exits the current screen without resetting to factory values.

CONTEXT KEY	FUNCTION
	Starts the factory data reset phase.
	Exits the current screen without resetting.
	Factory reset.
	Cancel the factory data reset phase and goes back to the previous screen.

10.1 Memory Menu

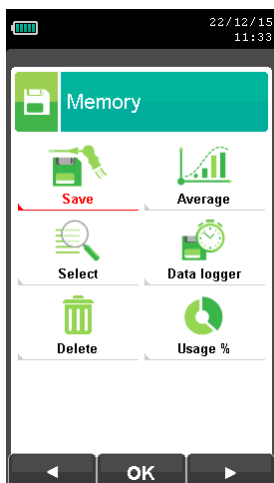



KEY	FUNCTION
	Activate the context keys shown on the display.
	Returns to the previous screen.

CONTEXT KEY	FUNCTION
	Selects the available parameters.
	Enters in the selected parameter setting.
	Selects the available parameters.

PARAMETER	DESCRIPTION
 Micromanometer	From this screen the user can start the combustion analysis. The data shown summarizes the mode of analysis and the selected memory. SEE SECTION 10.2.
 Average	Allows the user to see the average of the analyses contained in the selected memory. SEE SECTION 10.3.
 Select	<ul style="list-style-type: none"> - Allows the user to choose the memory position to be used to save the combustion analysis and/or the draft/pressure measurement. For each memory it is possible to enter the personal information of the customer (name of the customer, address, telephone number, type of combustion equipment, etc.). - Allows the user to see and print the stored analyses, individually or as an average. The analyses can be found (via the context key "find") by memory location or by the date they were saved; it is also possible to see the draft, carbon black and ambient CO. In the menu "Find Memory" the activation of the Print Memory is enabled only on the page where the analyses or the draft, carbon black and ambient CO data are displayed. SEE SECTION 10.4.
 Data logger	<p>This submenu allows the user to define the mode of analysis and of memory selection:</p> <p>Automatic analysis modes: UNI 10389 - See section '10.5.2 Details on UNI 10389 - BlmSchV - data logger' The factory settings of the device are in accordance with the Italian standard UNI 10389-1, which requires that you perform at least 3 samples spaced at least 120 sec. BlmSchV - See section '10.5.2 Details on UNI 10389 - BlmSchV - data logger' The factory settings of the device are in accordance with the German standard BlmSchV, which requires that you perform at least 30 samples spaced 1 sec. data logger - See section '10.5.2 Details on UNI 10389 - BlmSchV - data logger'</p> <p>This mode is entirely configurable by the user (it is necessary to set the number of samples to be acquired, the duration of acquisition of each sample and the printing mode). When the combustion analysis starts, the device will automatically carry out and store the number of samples set, spaced from one another according to the set time. After the combustion analysis (indicated by a beep), if the "Manual Print" mode has been selected, the device will display the average of the samples taken with the possibility to recall them individually; the user can then print them (total, complete, ...). On the contrary, if the user has selected the option "Automatic Print", the device will automatically proceed to print the analyses, according to the current printing settings, without displaying the average.</p>



 <p>Data logger</p>	<p>periodic - see section "10.5.3 Memory > Data logger > Data logger". This mode can be completely configured by the user and allows to monitor the emissions of pollutants at set intervals of time. The start of the analysis of the emissions can be set by the user (immediately or at a scheduled day and time). When the emission analysis begins, the instrument shall automatically acquire and store the set number of samples. During the acquisition it is possible to monitor the performance.</p> <p>NOTE: IN THIS ANALYSIS MODE THE ANALYZER MUST BE CONNECTED TO THE MAINS SUPPLY. THE INSTRUMENT AUTO-ZEROING IS PERFORMED AT THE BEGINNING OF EVERY ANALYSIS CYCLE AND IN ANY CASE ON AN HOURLY BASIS; THE DURATION SHALL BE SET BY THE USER. At the end of the analysis of emissions (an audible alarm will be emitted) the instrument shall display the average acquired samples. The stored tests can be displayed and individually printed directly from the instrument or transferred to the PC for further processing. Warning: in automatic mode, the measurements of carbon black, draft and ambient CO must be taken before starting the combustion analysis.</p> <p>Manual analysis mode - See section '10.5.1 Details on manual mode'. If the user chooses the manual mode, he will perform the combustion analysis manually; in this case, the settings regarding printing and duration of the automatic analysis will not be considered. At this point the user can start the manual analysis after waiting for the measured displayed to stabilize. Then he can proceed to save or directly print the data, which will be prepared in accordance with the previously configured settings. At the end of the three analyses, the screen with the average can be displayed, which also contains all the data necessary to fill in the booklet of the system or plant.</p> <p>Memory selection mode Manual: the memory will have to be selected manually via the parameter "Select" Auto: the memory, to which the measurements and combustion analyses will be saved, will be suggested automatically when the device is turned on. SEE SECTION 10.5.</p>
 <p>Delete</p>	<p>Allows the user to delete the contents of each memory or of all memories. SEE SECTION 10.6.</p>
 <p>Usage %</p>	<p>The user, through this menu, can view the percentage of memory usage. SEE SECTION 10.7.</p>

10.1.1 Memory Organization

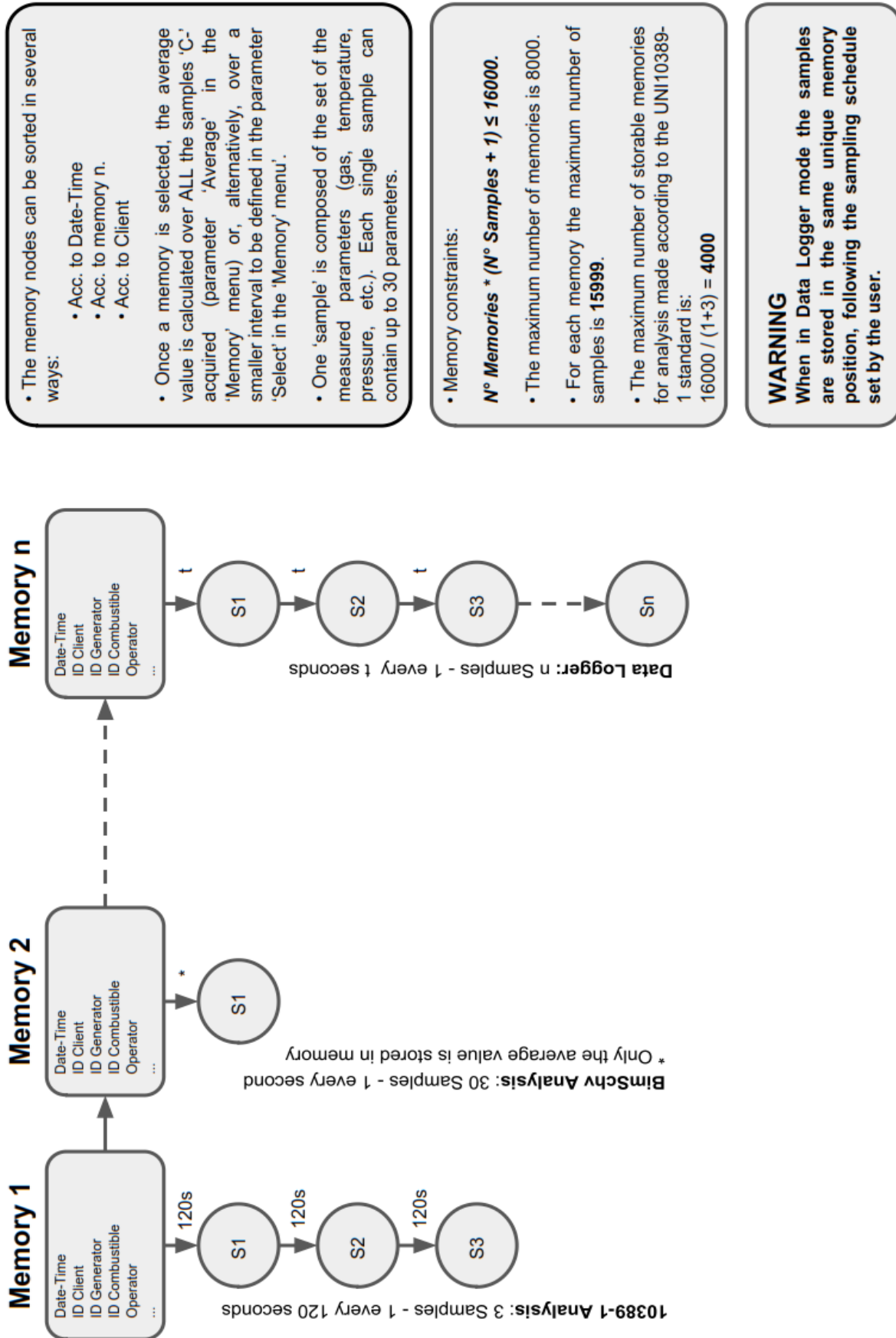

10.2 Memory Menu → Save

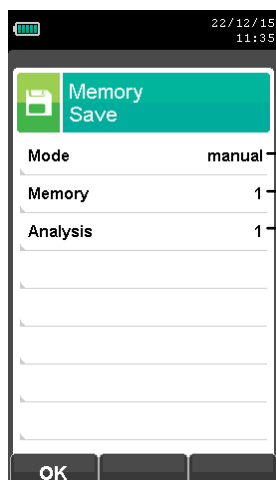

Manual analysis mode
 Number of selected memory
 Number of analyses carried out

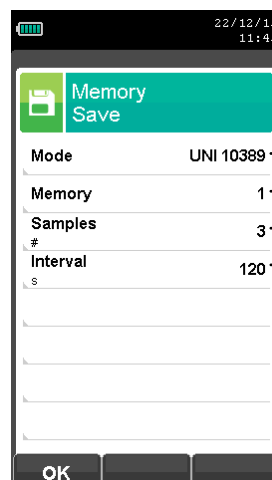

Automatic analysis mode
 Number of selected memory
 Number of samples to take
 Interval between samples

KEY	FUNCTION
	Activate the context keys shown on the display.
	Starts saving the combustion analysis according to the mode set in the parameter 'Data logger'.
	Returns to the previous screen.

CONTEXT KEY	FUNCTION
	Starts saving the combustion analysis according to the mode set in the parameter 'Data logger'.
	Deletes the contents of the selected memory. (Visible when the selected memory contains previous analyses).
	Cancel the deletion of the contents of the selected memory. (Visible when the selected memory contains previous analyses).



Example 1: Saving the combustion analysis in manual mode

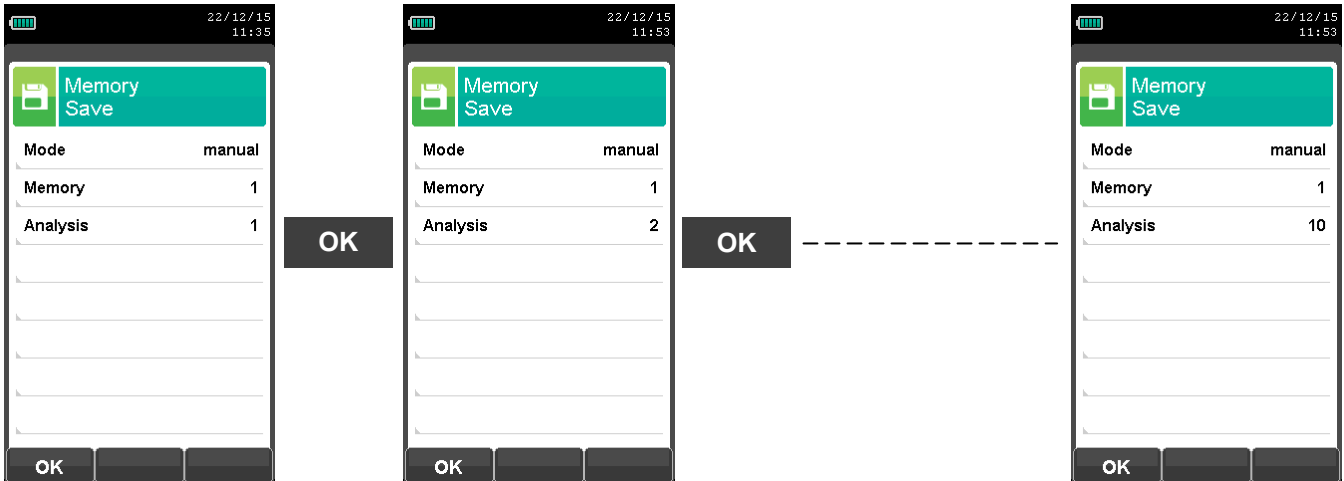

Example 2: Saving the combustion analysis in automatic mode (example UNI 10389)

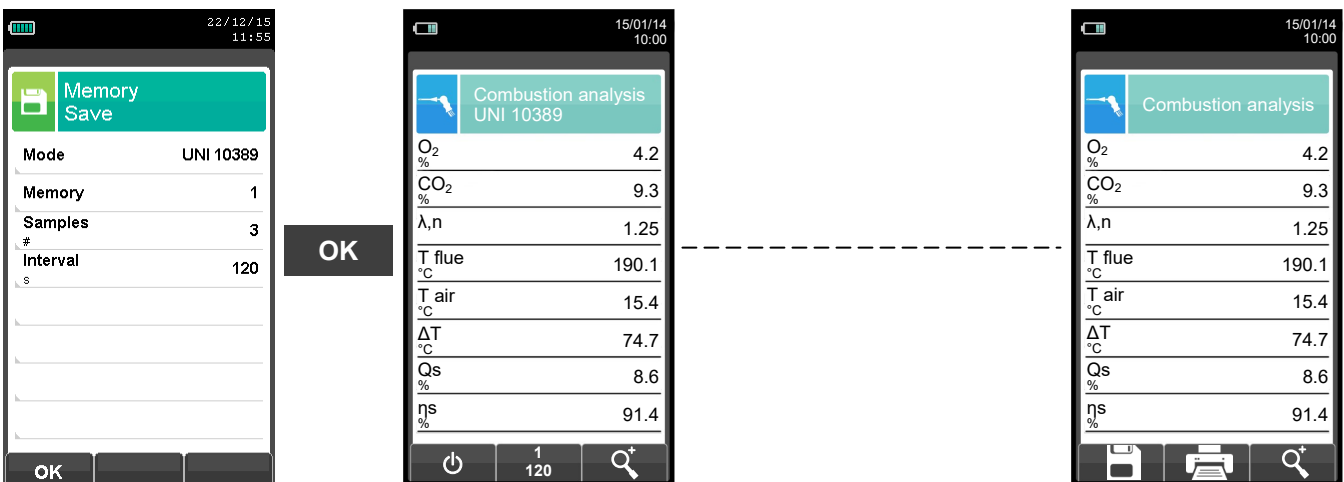

 FOR FURTHER INFORMATION SEE [SECTION 13 'COMBUSTON ANALYSIS'](#).

10.3 Memory Menu → Average

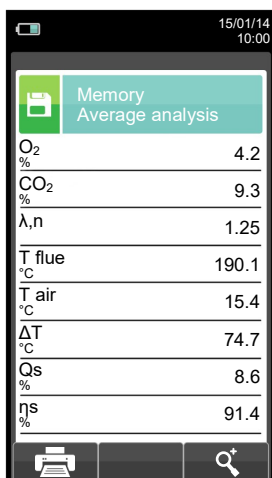

KEY	FUNCTION
	Activate the context keys shown on the display.
	Scrolls through the values of the average analysis.
	Activates the context key located in the left side of the display.
	Returns to the previous screen without saving the changes made.

CONTEXT KEY	FUNCTION
	Starts printing the test paper print-out. See section 11.
	Displays the status of the heated line when the stored analysis is performed.
	Zoom. By pressing this interactive key repeatedly, the device displays the following sequence: AAA → AAA → AAA → AAA

10.4 Memory Menu → Select

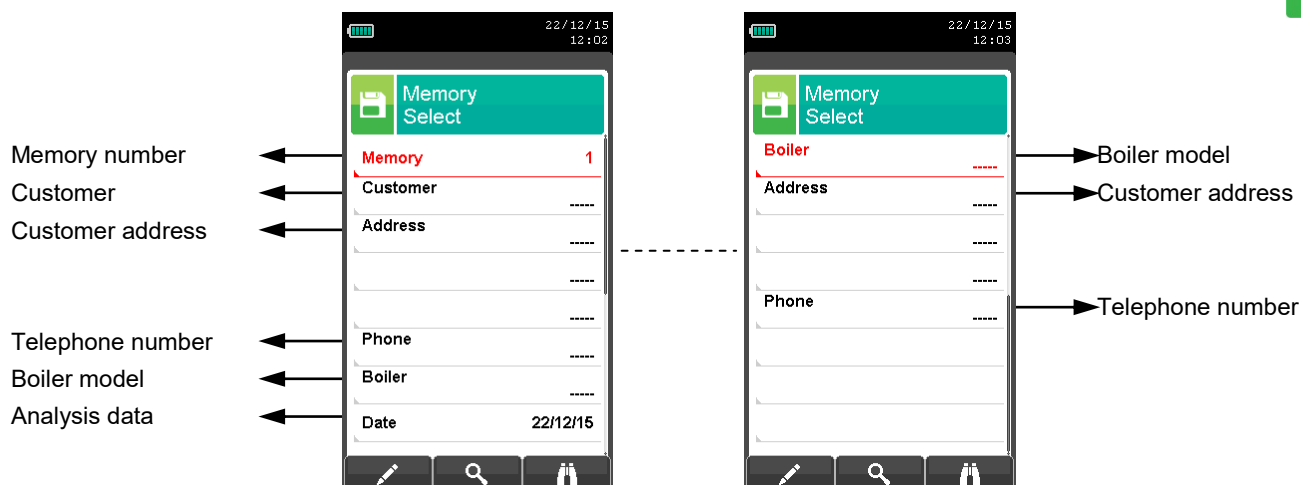

KEY	FUNCTION
	Activate the context keys shown on the display.
	In "edit text"/"search for data"/"search for memory number": it moves the cursor on the box corresponding to the desired letter or number.
	Selects line; the selected line is displayed in red.
	Activates the context key located in the left side of the display.
	Returns to the previous screen without saving the changes made.

CONTEXT KEY	FUNCTION
	Enters the modification mode for the selected parameter. It is possible to select the number of the memory to use for the combustion analysis and/or to enter the information relative to the plant.
	Recall memory. By activating this function, the user has the possibility to view the data present in the selected memory. Measurement conditions, single analysis, average analysis. SEE SECTION 10.4.1.
	Search function. Thanks to this function, the user has the possibility to quickly search for a specific analysis. The search can be carried out considering the memory number (by selecting the parameter "Memory"), the customer (by selecting one of the following parameters: "Customer", "Address", "Telephone" or "Generator") or the date (by selecting the parameter "Date").
	Confirms the settings and, if the search function is enabled, it starts the research.
	In "Edit text" it confirms the input of the selected letter or number.
	In "Edit text" it cancels the letter or number that precedes the cursor.
	In "Edit text" it goes from uppercase to lowercase, to symbols, to special characters.
	Selects the memories within the range of the research carried out.
	Selects the memories within the range of the research carried out.



10.4.1 Memory Recall

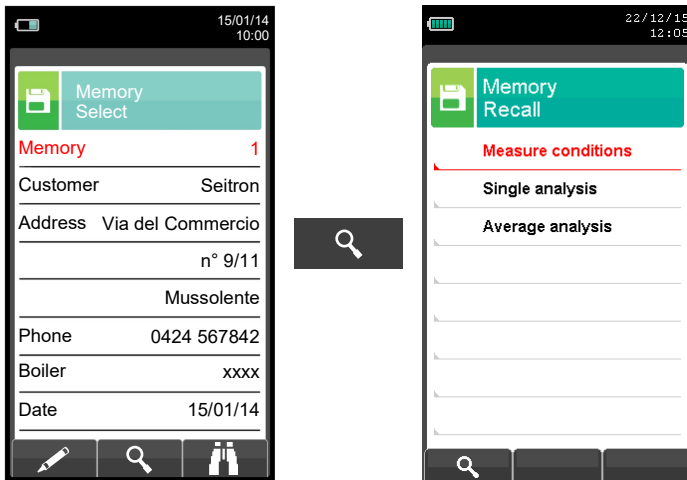

KEY	FUNCTION
	Activate the context keys shown on the display.
	Selects line; the selected line is displayed in red.
	Activates the context key located in the left side of the display.
	Returns to the previous screen.

CONTEXT KEY	FUNCTION
	Displays the details of the selected parameter.

1. Details of measurement conditions

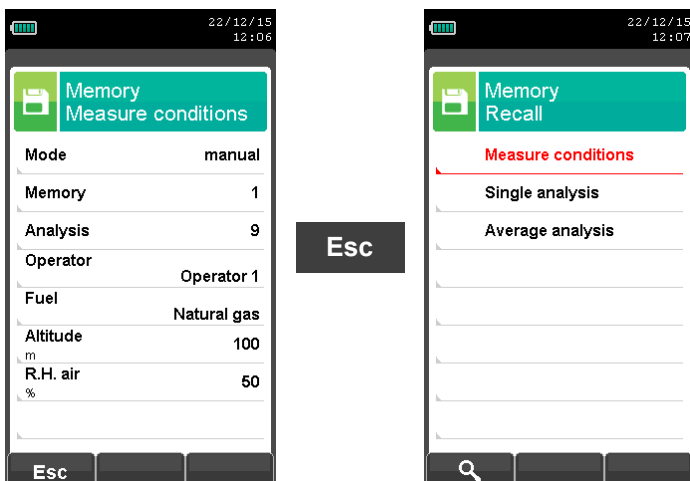

CONTEXT KEY	FUNCTION
	Returns to the previous screen.



2. Details of Single analysis

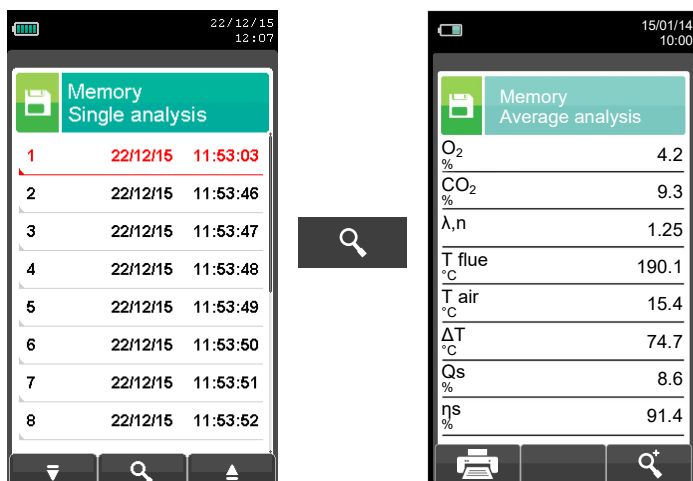

KEY	FUNCTION
	Activate the context keys shown on the display.
	Selects line; the selected line is displayed in red. In "view detail" the previous or next pages are shown.
	Views the details of the selected parameter.
	Returns to the previous screen.

CONTEXT KEY	FUNCTION
	Selects line; the selected line is displayed in red.
	Views the details of the selected parameter.
	Selects line; the selected line is red.
	Jumps to next page.
	Jumps to previous page.
	Starts printing the test paper print-out. See section 11.
	Displays the status of the heated line when the stored analysis is performed.
	Zoom. By pressing this interactive key repeatedly, the device displays the following sequence: AAA → AAA → AAA → AAA



3. Average analysis details

Defines the **start** sample to define the analysis average.

Defines the **end** sample to define the analysis average.

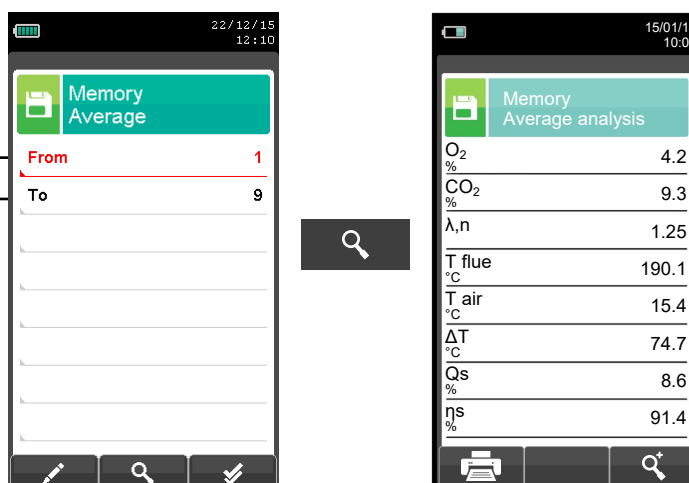

KEY	FUNCTION
	Activate the context keys shown on the display.
	In edit mode, it sets the number of the desired sample; the number to change is red.
	Selects line; the selected line is displayed in red.
	Activates the context key located in the left side of the display.
	Returns to the previous screen without saving the changes made.

CONTEXT KEY	FUNCTION
	Enters edit mode: it is possible to select the number of the sample to use to have the average of the analysis carried out.
	Shows the average analysis in the interval set.
	Zoom. By pressing this interactive key repeatedly, the device displays the following sequence: AAA → AAA → AAA → AAA
	Sets all the samples of the analyses carried out: From 1 (first sample) To xxx (last sample).
	Confirms the settings.
	Starts printing. See section 11.
	Displays the status of the heated line when the stored analysis is performed.

10.5 Memory Menu → Data logger



In this submenu the user can set the analysis modes and the relating parameters. 4 automatic modes and 1 manual mode can be selected.

Note: The display of parameters is contextual to the selected analysis mode.

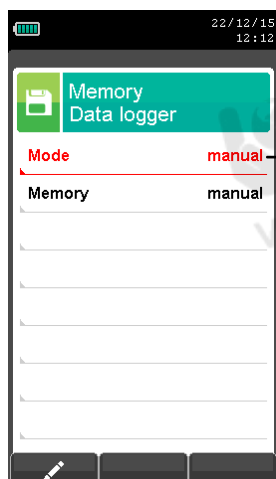

The selectable analysis modes are:
manual - UNI 10389 - BlmSchV - data logger - periodic

KEY	FUNCTION
	Activate the context keys shown on the display.
	Returns to the previous screen.

CONTEXT KEY	FUNCTION
	Enters the modification mode for the selected parameter.





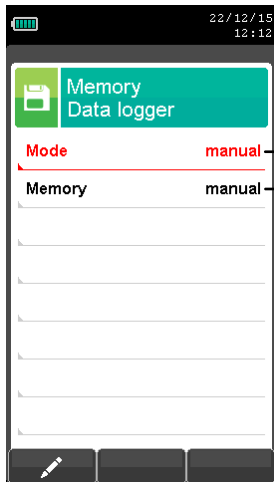

10.5.1 Manual mode details



→ Manual selection mode

→ The memory selection modes are: **manual** or **auto**.
If "auto" mode has been selected, the research of the available memory will be performed automatically when the device is turned on).

KEY	FUNCTION
	Activate the context keys shown on the display.
	Selects the line; the selected line is highlighted in red. When in change mode sets the desired value or mode.
	Activates the context keys located in the left side of the display.
	Returns to the previous screen.

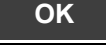
CONTEXT KEY	FUNCTION
	Enters the modification mode for the selected parameter.
	Confirms the settings.

10.5.2 Details on UNI 10389 - BlmSchV - data logger

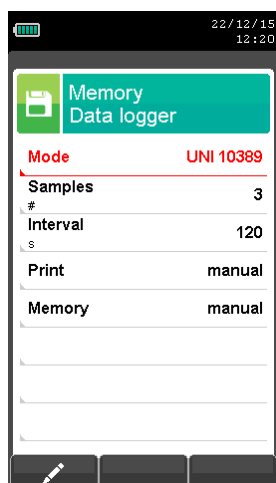

- Selected modes: **manual - UNI 10389 - BlmSchV - data logger - periodic**
- Number of samples to acquire.
- Lapse of time between one sample and the next one.
- The selectable printing modes are: **manual** or **auto**.
If "**auto**" mode has been selected, the printing will be performed automatically at the end of the combustion analysis (parameter not visible in manual analysis mode).
- The memory selection modes are: **manual** or **auto**.
If "**auto**" mode has been selected, the research of the available memory will be performed automatically when the device is turned on).

KEY	FUNCTION
	Activate the context keys shown on the display.
	Selects the line; the selected line is highlighted in red. When in change mode sets the desired value or mode.
	Activates the context key located in the left side of the display.
	Returns to the previous screen.

CONTEXT KEY	FUNCTION
	Enters the modification mode for the selected parameter.
	Confirms the settings.



10.5.3 Details of periodic mode

Mode periodic → Selected mode: **periodic**

Samples # 10 → Number of samples to acquire.

T sampling s 60 → Lapse of time between a sample and the next one.

Cycles # 10 → Number of cycles to be performed within 24 hours.
*: number of times the instrument acquires the set number of samples.

T cycle s 900 → Lapse of time between the start of one cycle and the start of the next one.

Repetitions # 1 → Number of times you want to repeat the acquisition of cycles in the following days.

Autozero min 3 → Duration of the autozero that will be executed at the beginning of each analysis cycle or every hour if the duration of the cycle is longer than an hour.

Purging min 3 → Duration of cleaning that will be carried out at the end of each analysis cycle.

Start date --/--/-- → Start date of emissions analysis.

Start time --:-- → Start time of emissions analysis.

KEY	FUNCTION
	Activate the context keys shown on the display.
	Selects the line; the selected line is highlighted in red. When in change mode sets the desired value or mode.
	Activates the context key located in the left side of the display.
	Returns to the previous screen.

CONTEXT KEY	FUNCTION
	Enters the modification mode for the selected parameter.
	Confirms the settings.

Operational logic of the periodic mode

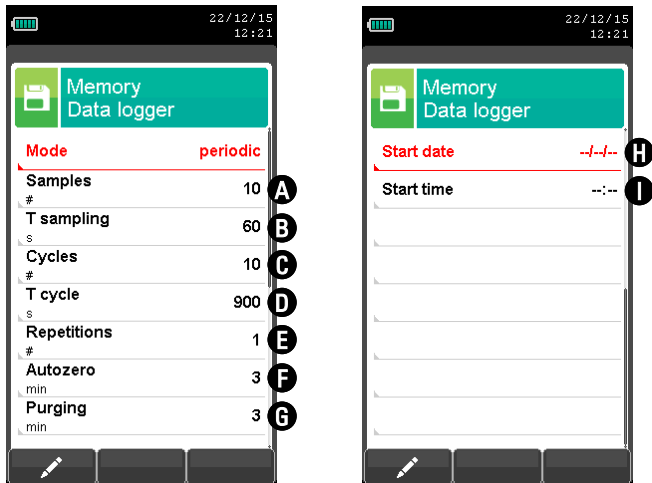

WARNING



- When in periodic mode, the heated line (if included and enabled) is always working.
- The heated line is activated 20 minutes before the analysis starts.

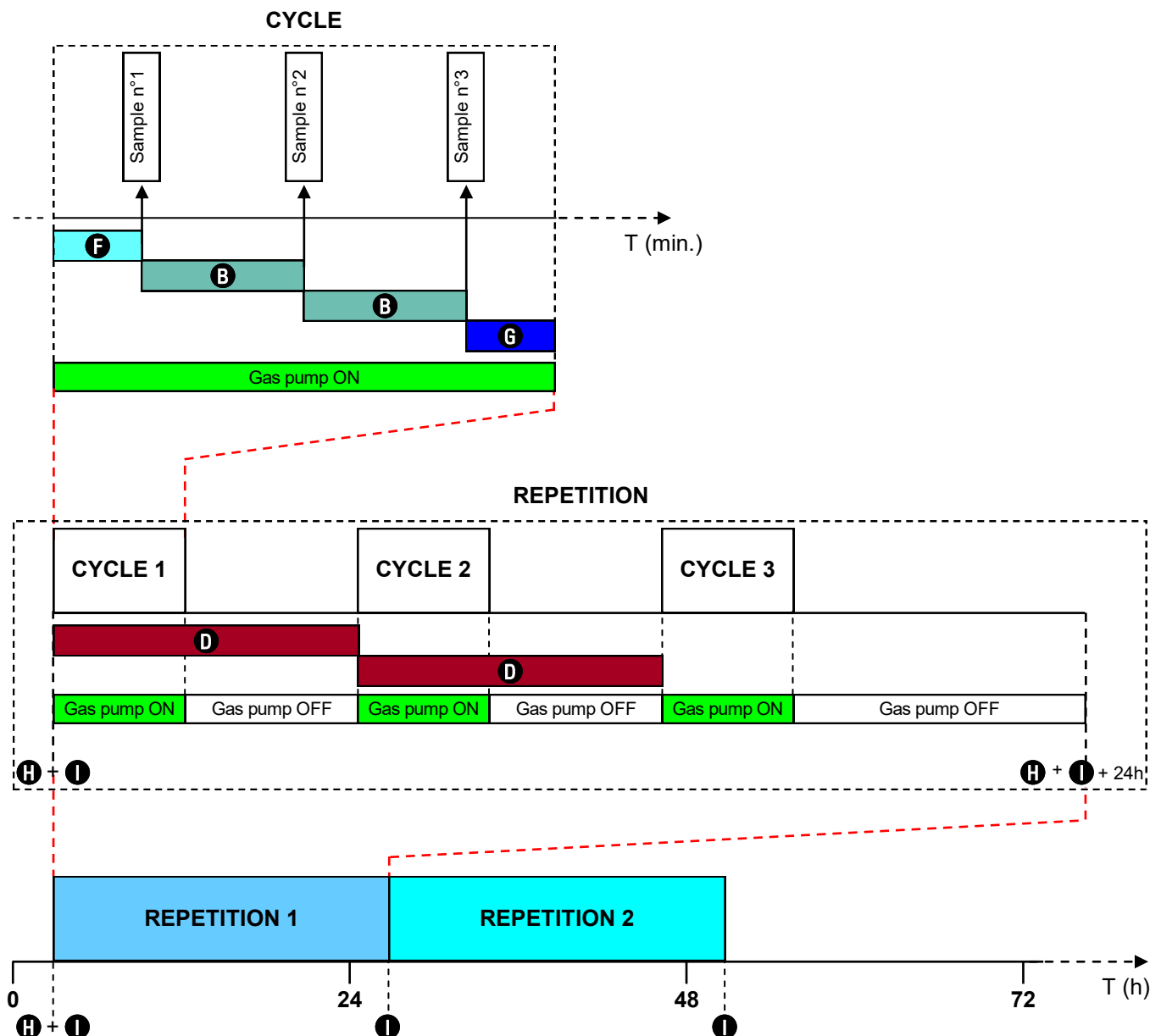

Operating modes relating to the above settings:

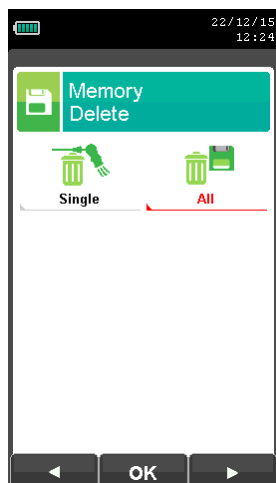



10.6 Memory→Delete



KEY	FUNCTION
	Activate the context keys shown on the display.
	Returns to the previous screen.

CONTEXT KEY	FUNCTION
	Selects the available parameters.
	Enters in the selected parameter setting.
	Selects the available parameters.

PARAMETER	DESCRIPTION
 Single	This option allows the user to delete the contents of each individual memory; to do this, the user will have to confirm the operation so as to avoid losing previously saved data. SEE SECTION 10.6.1.
 All	This option allows the user to delete the contents of all the memories; to do this, the user will have to confirm the operation so as to avoid losing previously saved data. SEE SECTION 10.6.2.



IT IS TO BE CONSIDERED NORMAL THAT THE MEMORIES ERASING PROCESS REQUIRES SOME MINUTES.

10.6.1 Memory→Delete→Single

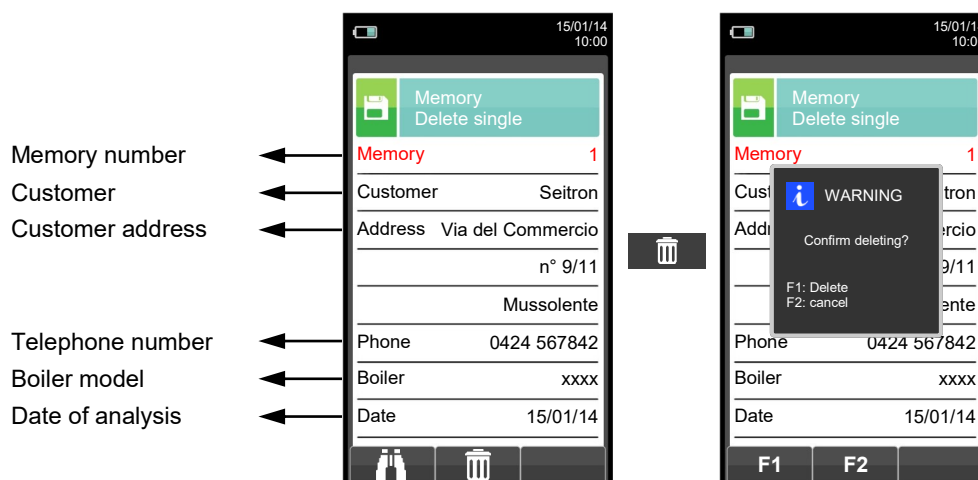

Memory number
Customer
Customer address

Telephone number
Boiler model
Date of analysis

KEY	FUNCTION
	Activate the context keys shown on the display.
	In "edit text"/"search for data"/"search for memory number": it moves the cursor on the box corresponding to the desired letter or number.
	Selects line; the selected line is displayed in red.
	Activates the context key located in the left side of the display. In "edit text": Confirm text insertion.
	Returns to the previous screen.

CONTEXT KEY	FUNCTION
	Search function. Thanks to this function, the user has the possibility to quickly search for a specific analysis. The search can be carried out considering the memory number (by selecting the parameter "Memory"), the customer (by selecting one of the following parameters: "Customer", "Address", "Telephone" or "Generator") or the date (by selecting the parameter "Date").
	Confirms the settings and, if the search function is enabled, it starts the research.
	In "Edit text" it confirms the input of the selected letter or number.
	In "Edit text" it cancels the letter or number that precedes the cursor.
	In "Edit text" it goes from uppercase to lowercase, to symbols, to special characters.
	Selects the memories within the range of the research carried out.
	Selects the memories within the range of the research carried out.
	Starts deleting the selected memory.
	Deletes the selected memory.
	Cancel the deleting and goes back to the previous page.



10.6.2 Memory→Delete→All

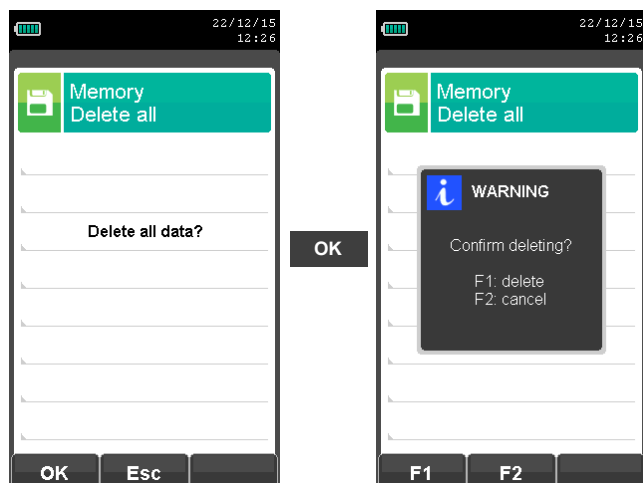

KEY	FUNCTION
	Activate the context keys shown on the display.
	Start erasing all memories.
	Returns to the previous screen.

CONTEXT KEY	FUNCTION
	Start erasing all memories.
	Returns to the previous screen.
	Deletes all memories.
	Cancel the deleting and returns to the previous page.

10.7 Memory→Usage %

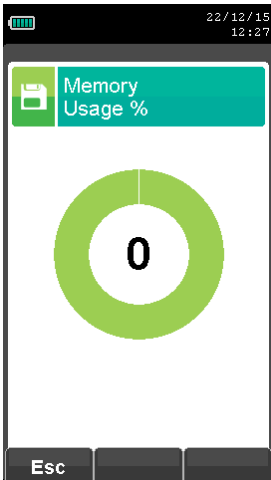

KEY	FUNCTION
	Activate the context keys shown on the display.
	Returns to the previous screen.

CONTEXT KEY	FUNCTION
	Returns to the previous screen.

11.0 PRINT

11.1 Print Menu

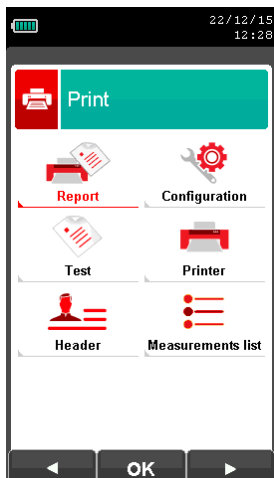

KEY	FUNCTION
	Activate the context keys shown on the display.
	Returns to the previous screen.

CONTEXT KEY	FUNCTION
	Selects the available parameters.
	Enters in the selected parameter setting.
	Selects the available parameters.

PARAMETER	DESCRIPTION
Report	Enables the Print Menu. A hard copy of the complete combustion analysis can be printed. The printed values are those shown on the display when the menu is enabled. This menu can be used for combustion analysis, even when recalled from the memory, for draft, smoke, ambient gas and for tightness test results. SEE SECTION 11.2.
Configuration	The user, by means of this menu, can configure the test report format: Copies: Allows to set the number of printed copies and layout of the paper print-out. Several copies of the test paper print-out can be printed, choosing among different layouts according to the information included. Report: The paper print-out layout selection is only valid for combustion analysis and can be chosen among Complete, Partial and Total. Paper print-outs for draft, smoke, ambient gas concentration and tightness test only allow a specific layout. Layouts options for combustion analysis are specified as described in the following: Full: includes a header with company data as well operator data previously programmed in the configuration menu, measurements sampled in the combustion analysis and, when sampled, the draft, smoke and CO ambient gas values. Partial: only reports the combustion analysis measurement values and information, without any header, comments or blank lines for operator comments. Total: prints full print-out of average values with individual test data. Date/Time: It allows you to define whether or not to print the date and time at which the combustion analysis was performed. Manual: The date and time are not printed in the header of the analysis report . It is the responsibility of the operator to enter the data manually . Auto: The date and time are printed in the header of the analysis report. SEE SECTION 11.3.
Test	Print: Prints a graphical/alphanumeric test paper print-out for a complete check of the printer operation. Paper feed: Feeds paper in the printer; this function is most useful when replacing the paper roll in the printer. SEE SECTION 11.4.
Printer	Selects the printer type: internal or Bluetooth®. When Bluetooth® printer is selected a pairing procedure will be needed in order to match the printer to the instrument. The pairing procedure has to be performed only once. SEE SECTION 11.5.
Header	Allows the user to enter, in six lines of 24 characters each the name of the Company or owner of the device or the information regarding the latter (e.g. address, telephone number), which will be printed in the header of the analysis report. SEE SECTION 11.6.
Measurements list	In this submenu the user has the possibility to view the list of measurements that the device performs. With the interactive keys, the user can add, delete or move a selected measurement. SEE SECTION 11.7.



11.2 Print→Report

```

Date: 15/01/14
Time: 10.10
Fuel: Natural gas
Altitude: 0 m
R.H. air: 50 %
O2          4.2 %
CO2         9.3 %
λ,n         1.25
T flue     190.2 °C
T air      15.4 °C
dT         174.8 °C
QS          8.6 %
Es          91.4 %
Ec          4.9 %
Et          96.3 %
CO          148 ppm
NO           40 ppm
NOX/NO:     1.03
NOX         41 ppm
CO amb      0 ppm
Draft:      0.05 hPa
T out:     20 °C
Smoke:      3 1 2
Aver. n:    2
    
```

KEY	FUNCTION
	Activate the context keys shown on the display.
	Returns to the previous screen.

CONTEXT KEY	FUNCTION
	Starts printing the test paper print-out.
	Stops printing the test paper print-out.



11.3 Print→Configuration

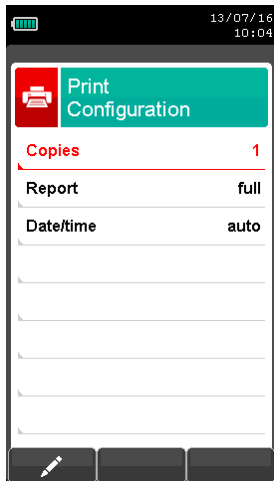

- Set the number of copies to print: 1 .. 5.
- The test paper print-out models that can be selected are: **partial - full - total**
For further details see Annex A.
- Set between: **Manual:** date and time are not printed on the analysis report.
Auto: date and time are printed automatically on the analysis report.

KEY	FUNCTION
	Activate the context keys shown on the display.
	Selects line; the selected line is displayed in red. In modification sets the value or the desired mode.
	Activates the context key located in the left side of the display.
	Returns to the previous screen. When in modify mode cancels the modification just made.

CONTEXT KEY	FUNCTION
	Enters the modification mode for the selected parameter.
	Confirms the settings.

Example:

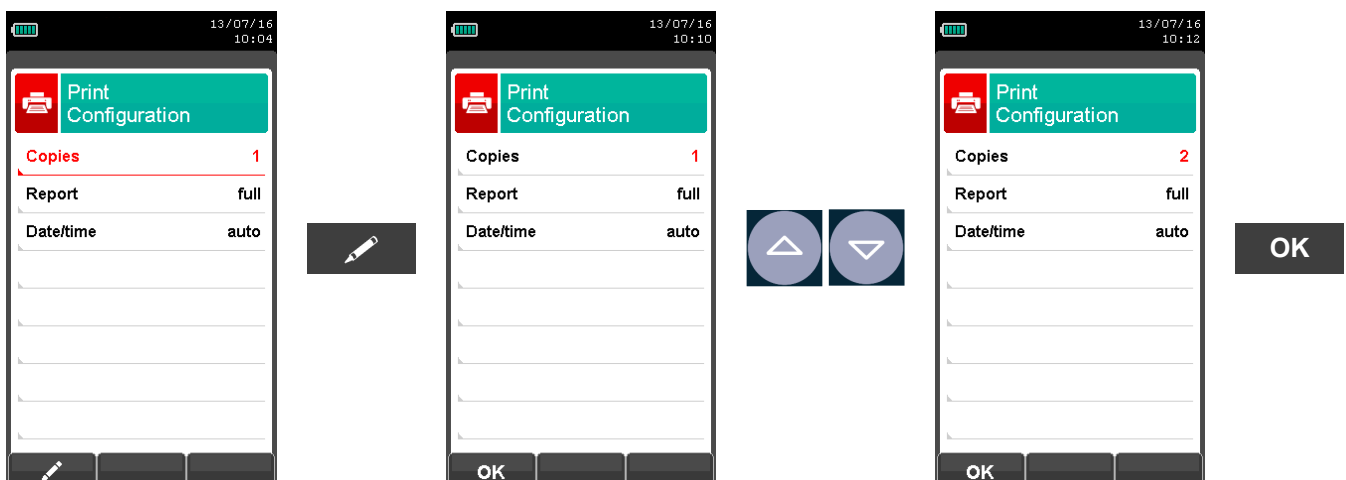



11.4 Print→Test



KEY	FUNCTION
	Activate the context keys shown on the display.
	Selects line; the selected line is displayed in red. In modification sets the value or the desired mode.
	Activates the context key located in the left side of the display.
	Returns to the previous screen. When in modify mode cancels the modification just made.

CONTEXT KEY	FUNCTION
	Confirms the settings.

Example:

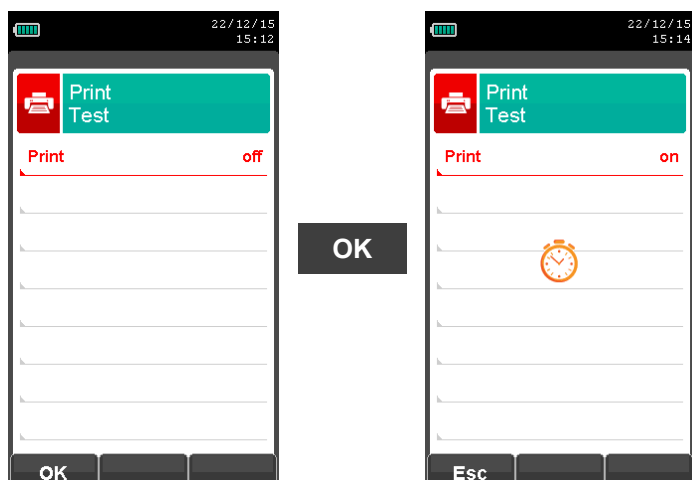



11.5 Print→Printer

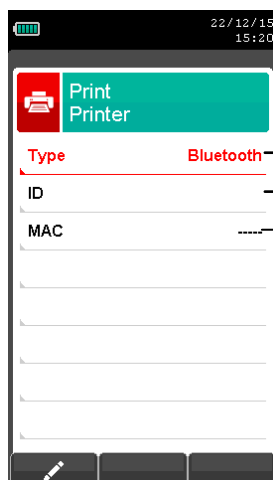
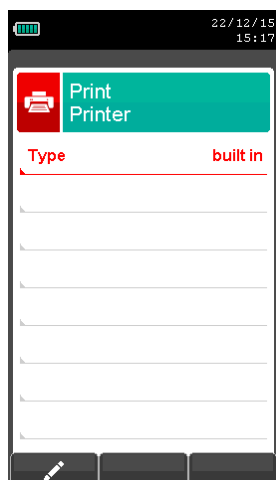

- Printer type: **built in (internal)/Bluetooth® (external)**.
- Name of the Bluetooth® printer associated with the instrument.
- Address of the Bluetooth® printer associated with the instrument.

WARNING

If you select the Bluetooth® printer, you will need to pair the instrument to a Bluetooth® printer. The pairing procedure must be performed once only.

KEY	FUNCTION
	Activate the context keys shown on the display.
	Selects line; the selected line is displayed in red. In modification sets the value or the desired mode.
	Activates the context key located in the left side of the display.
	Returns to the previous screen. When in modify mode cancels the modification just made.

CONTEXT KEY	FUNCTION
	Enters the modification mode for the selected parameter.
	Confirms the settings.

11.5.1 Print→Pairing

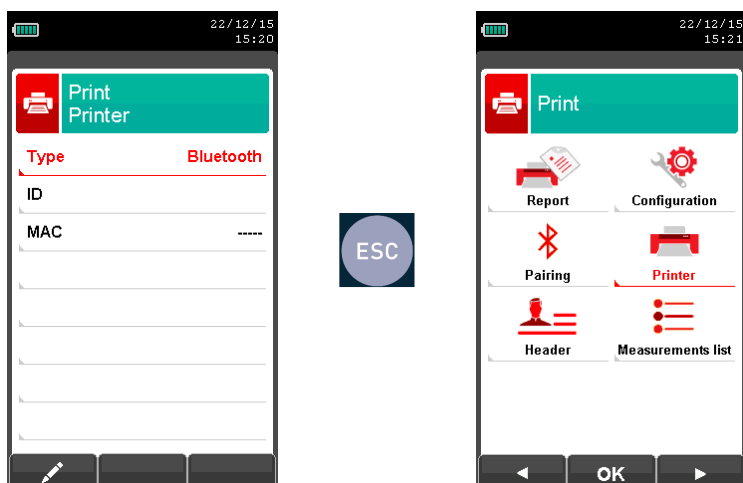

KEY	FUNCTION
	Activate the context keys shown on the display.
	Selects line; the selected line is displayed in red. In modification sets the value or the desired mode.
	Activates the context key located in the left side of the display.
	Returns to the previous screen. When in modify mode cancels the modification just made.

CONTEXT KEY	FUNCTION
	Selects the available parameters.
	Enters in the selected parameter setting.
	Selects the available parameters.
	Starts the search for Bluetooth® devices.
	Quits and returns to the previous screen.
	Enters the modification mode for the selected parameter.
	Repeats the pairing procedure.
	Confirms the settings.
	Confirms the selected letter or digit.
	Cancels the letter or digit before the cursor.
	Cycles through uppercase, lowercase, symbols and special characters.

In the following pages the pairing procedure between the instrument and a Bluetooth® printer is described.



1. Once the Bluetooth® printer is configured, proceed as follows:

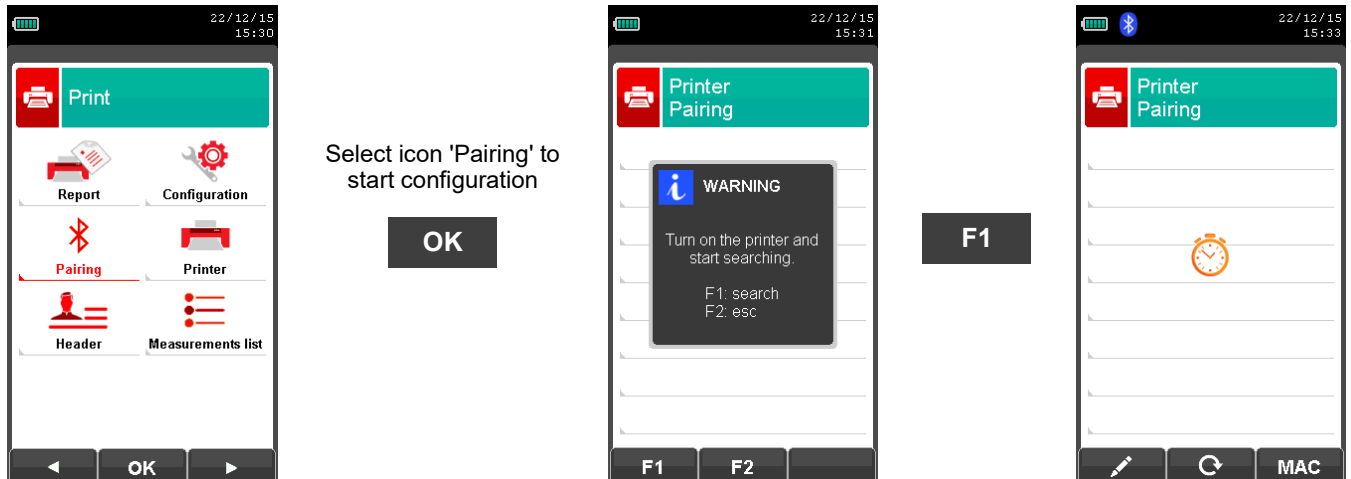

2. Select the line corresponding to the desired Bluetooth® printer, then proceed as follows:

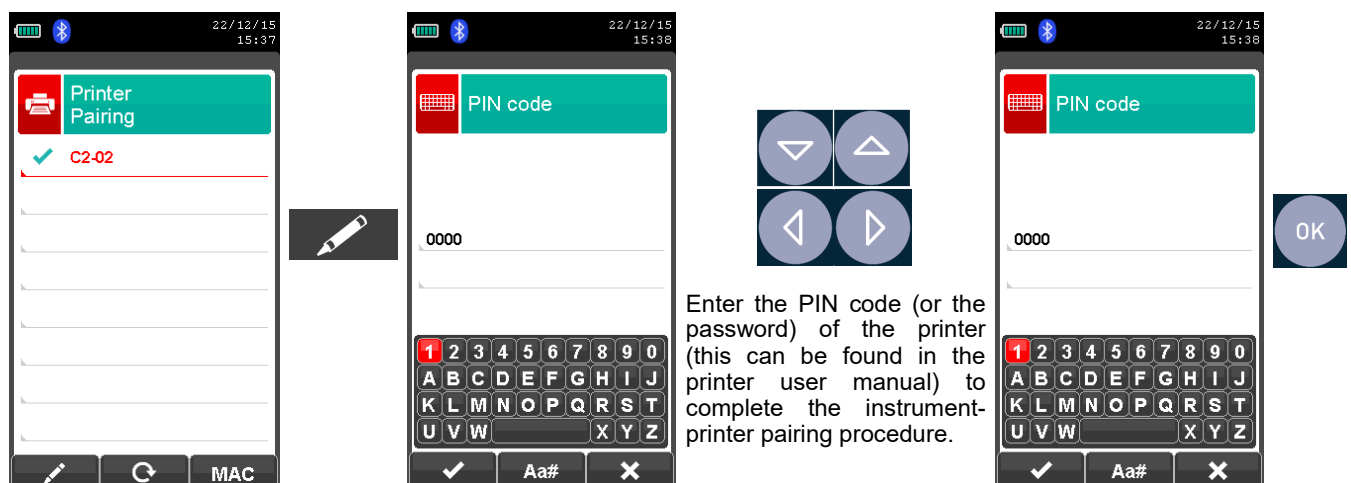

3. The instrument-printer pairing is completed. Press key '  ' to return to the previous screen.

11.6 Print→Header

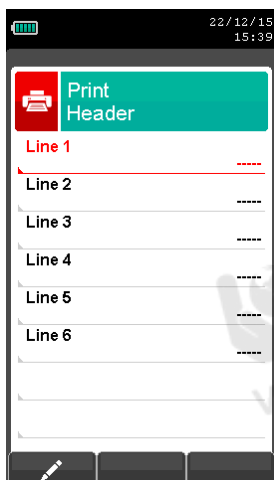

KEY	FUNCTION
	Activate the context keys shown on the display.
	In "edit text": It moves the cursor on the box corresponding to the letter or number required to form the desired word.
	In edit mode it moves the cursor through the available lines.
	In "edit text": it confirms the text input. In "Print header": It activates the context key displayed on the left.
	Returns to the previous screen. In "edit text" it goes back to the previous screen without saving the changes made.

CONTEXT KEY	FUNCTION
	Enters edit mode of the selected line: it is possible to enter the name of the operator (24 characters available).
	Confirms the selected letter or digit.
	Cancel the letter or digit before the cursor.
	Cycles through uppercase, lowercase, symbols and special characters.





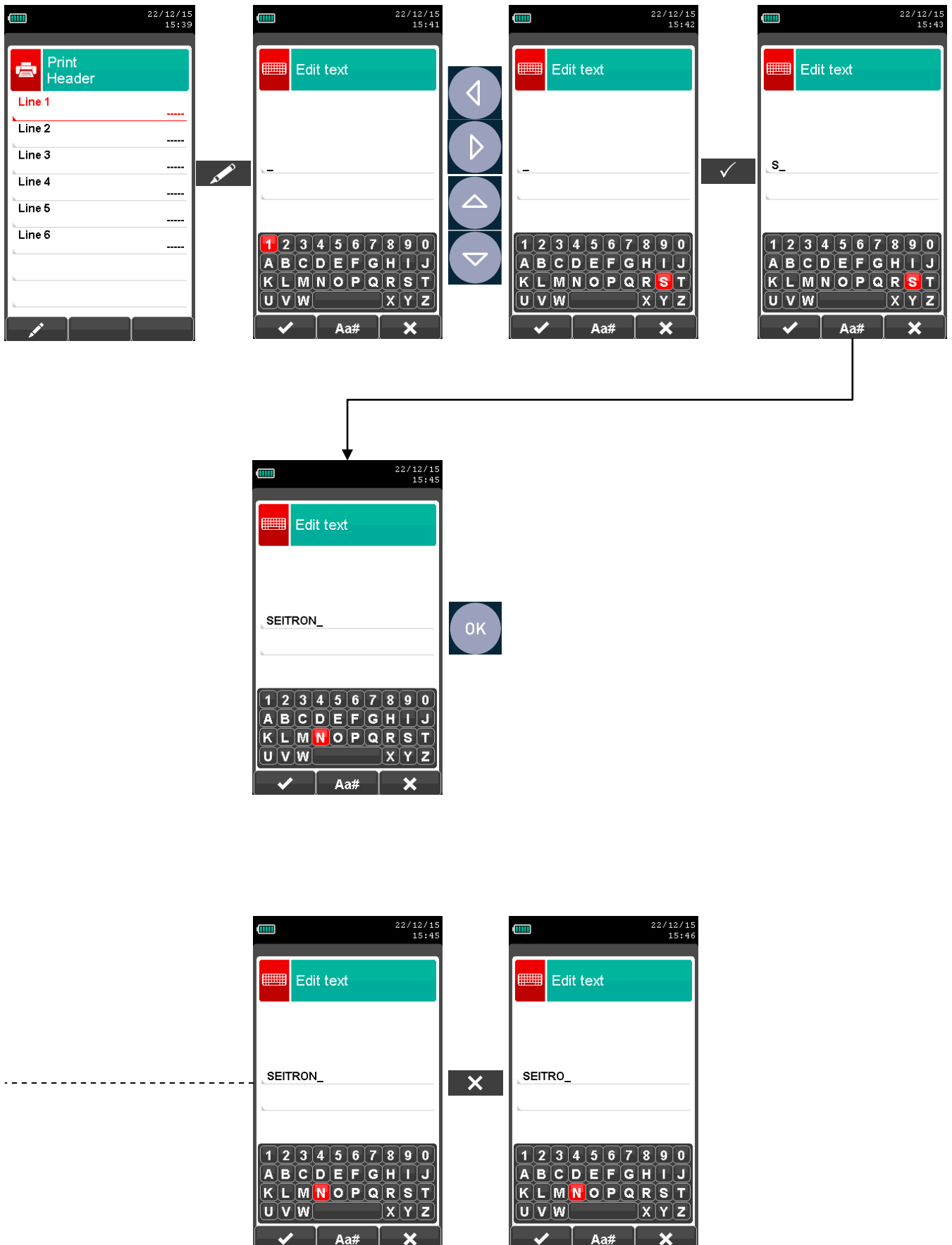

Example:



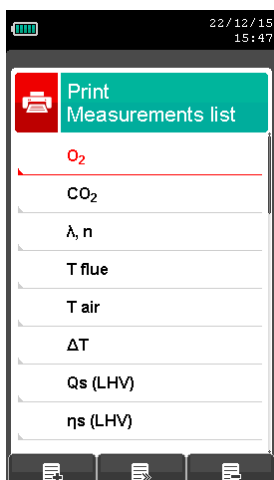



1. Edit text



11.7 Print→Measures list



KEY	FUNCTION
	Activate the context keys shown on the display.
	Selects the available measurements from the suggested list. In edit mode, it scrolls through the measurements present.
	Confirms the modification.
	When pressed in modify mode cancels the selection made, otherwise returns to the previous screen.

CONTEXT KEY	FUNCTION
	Adds a measurement.
	Moves the position of a measurement.
	Deletes a measurement from the list.
	Scrolls through the available measurements.
	Confirms the change made.
	Scrolls through the available measurements.
	Cancel the change made.



Example:

1. Add a measurement to the list

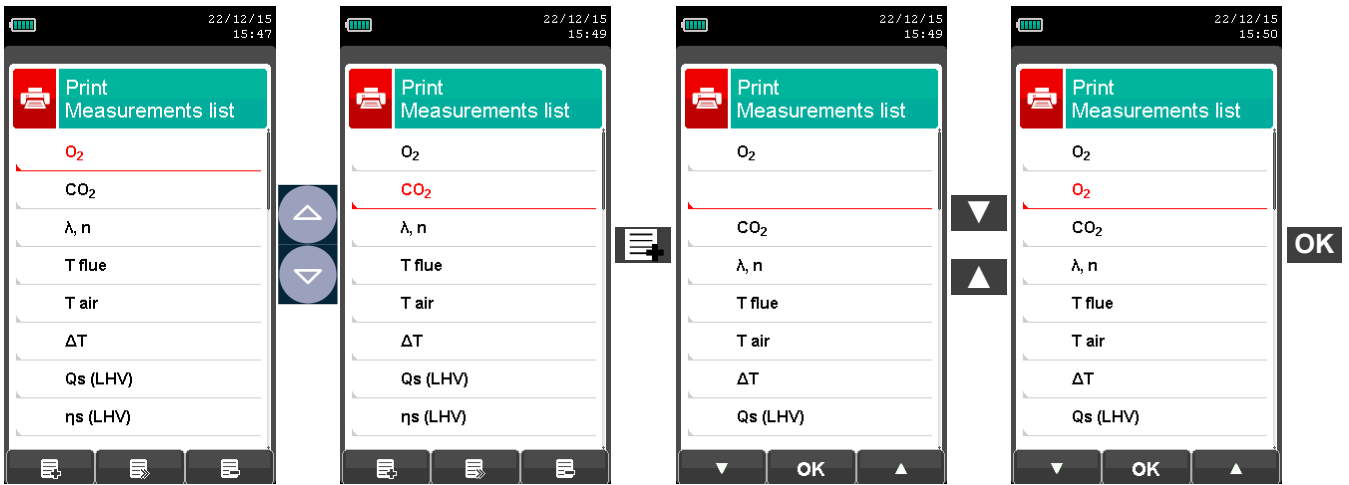

2. Move the position of a measurement

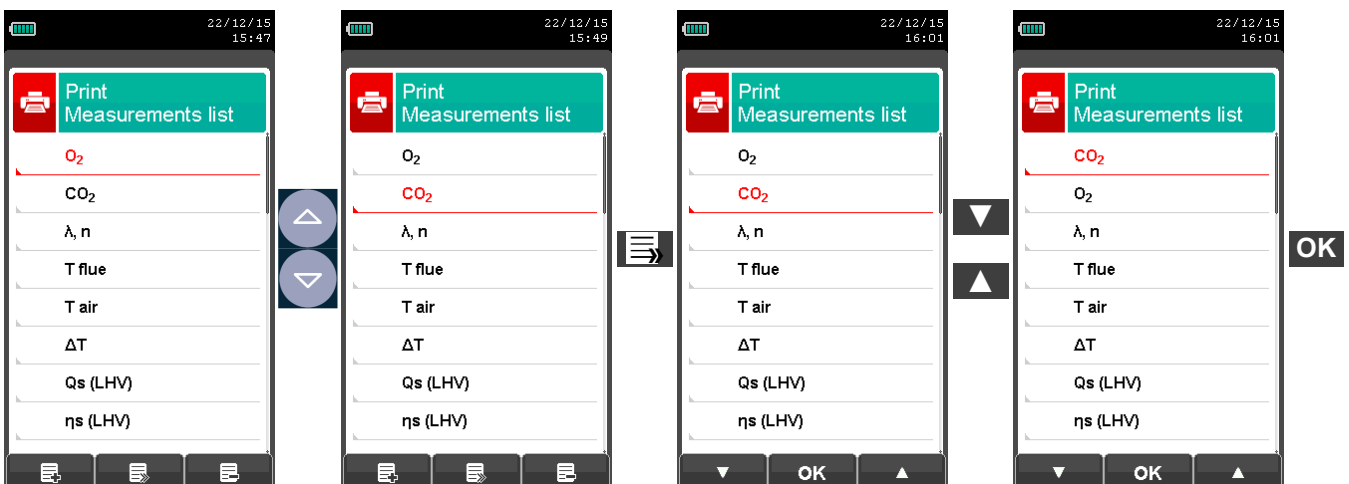

3. Deletes a measurement from the list

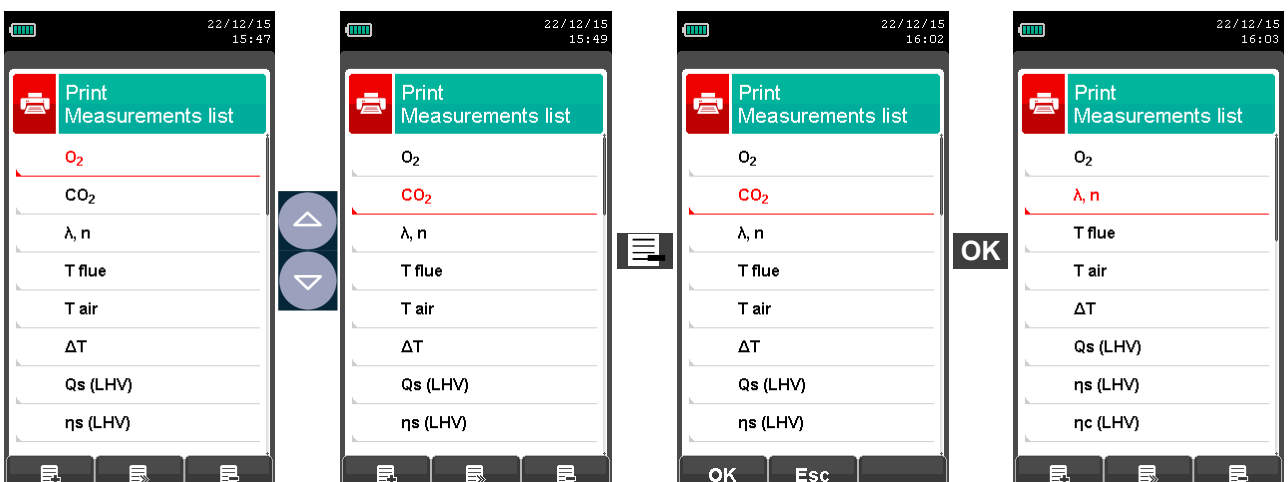

12.0 MEASUREMENTS



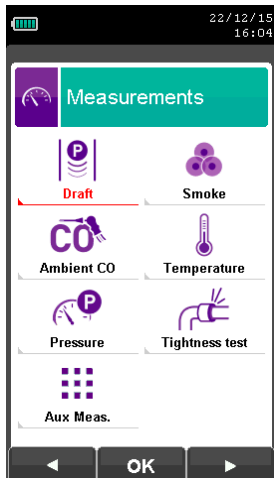

12.1 Measurements Menu



KEY	FUNCTION
	Activate the context keys shown on the display.
	Returns to the previous screen.
CONTEXT KEY	FUNCTION
	Selects the available parameters.
	Enters in the selected parameter setting.
	Selects the available parameters.

PARAMETER	DESCRIPTION
 Draft	<p>The DRAFT menu gives access to the stack draft measurement. Being a negative pressure, in accordance with standard UNI10845, draft must be measured using the negative pressure input P-. The correct values for a natural draft boiler are therefore positive by definition. Before performing the measurement the instrument allows the user to input the external air temperature as required by the standard. When making the measurement and the temperature has been inserted, the instrument provides a stack draft value related (P diff ref) to the external temperature of 20° C as requested by law. When the inserted external temperature is higher than 20° C the instrument reports a stack draft value reference equal to the measured draft. Afterwards the user can acquire the value displayed in order to add it to the running analysis measurements or, alternatively, print the relevant paper print-out through the 'PRINT' menu.</p> <p>NOTE: The measurement may not be accurate due to condensation inside the gas probe. Should you notice an inaccurate or unstable reading on the instrument, it is advisable to disconnect the gas probe from the instrument itself, and purge pipes by blowing with a compressor. In order to be sure there is no humidity, it is suggested to perform the measurement by means of the transparent rubber pipe supplied on issue.</p> <p>SEE SECTION 12.2.</p>
 Smoke	<p>It is possible to enter the data concerning one to three CARBON BLACK measurements taken by means of an optional device (SMOKE PUMP); see the relevant instructions. The method consists in taking a certain quantity of combustion gas from the middle of the flue behind the surfaces of the exchangers at the end of the boiler, and make it pass through a special filter paper. The soot stain obtained is compared with the surfaces blackened in a different way according to a comparison scale; it is thus determined the "soot number", which will be entered in the instrument by hand. These measurements can be either stored in memory together with the combustion analysis data or printed on a paper print-out.</p> <p>SEE SECTION 12.3.</p>
 Ambient CO	<p>This type of analysis lets the user measure the CO value present in the environment, with the scope of checking the personal safety conditions of a specific working environment. The instrument leaves our factory with the following preset threshold values:</p> <p>COmax: 35 ppm Recommended exposure limit (REL) stipulated by the National Institute for Occupational Safety and Health (NIOSH), equivalent to 40 mg/m³ and calculated as an 8-hour Time-Weighted Average (TWA).</p> <p> Make sure to perform to perform the autozero in a clean air environment (preferably outdoors), so that the ambient CO measurement is correct. It is advisable to turn on the instrument and wait for the autozero completion outside the area where the test is being performed.</p> <p>The instrument allows to carry out ambient CO measurements only by means of sensors for low CO concentrations.</p> <p>SEE SECTION 12.4.</p>



PARAMETER	DESCRIPTION
 <p>Temperature</p>	<p>With this menu it is possible to measure the temperature of the supply water, by means of an OPTIONAL thermocouple K-type contact probe to be connected to the input T1. Also, it is also possible to measure the temperature of the return water, by connecting an OPTIONAL thermocouple K-type contact probe to be connected to the input T2. With the function ΔT it is possible to obtain the relevant temperature difference.</p> <p>SEE SECTION 12.5.</p>
 <p>Pressure</p>	<p>It is possible, through the use of the external flexible pipe made in RAUCLAIR (supplied), to measure a pressure value within the range stated in the technical features (connect the pipe to P+ input). During the pressure measurement the 'HOLD' function is made available, which allows to 'freeze' the value shown on the display, by pressing 'HOLD' key.</p> <p>SEE SECTION 12.6.</p>
 <p>Tightness test</p>	<p>According to the version, CHEMIST 900 can perform the tightness test on heating plants which use combustible gases according to the standards UNI 7129-1: 2015 and UNI 11137: 2019, respectively applicable to new or renewed piping and to existing piping, or according to the German standard DVGW TRGI 2008. The result of this tightness test, whose steps are described in the following, can be printed, once acquired, by starting the ' print menu ' in any of the screens of the ' Tightness Test ' menu.</p> <p>SEE SECTION 12.7 .. 12.12.</p>
 <p>Aux. Meas.</p>	<p>Through this menu the user can access additional measures.</p> <p>SEE SECTION 12.13.</p>

12.2 Measurements → Draft



This screen is shown if a draft gauge is used to measure the draft.

KEY	FUNCTION
	Activate the context keys shown on the display.
	Sets the value of the external temperature.
	Returns to the previous screen.

CONTEXT KEY	FUNCTION
	The activation of one of these keys starts the Draft measurement.
	Carries out pressure zeroing.
	Saves, in the memory selected in the "Memory Select" menu, the value of the draft measured.
	Starts printing the test paper print-out. See section 11.

To measure the draft proceed as follows:

- Connect the probe pressure input hose to the instrument **P-** input.
- Enter the external air temperature.
- Before starting the pressure zeroing sequence pay attention to remove the gas probe from the stack.
- Having carried out the pressure zeroing sequence, insert the probe in the chimney and measure the draft.
- The draft values to be stored in the memory must be acquired before storing the analysis data.
- To attach the draft value to the readings of the current analysis, activate the "save" function ' '.
- To print the test paper print-out with the value of the draft, activate the function ' '.
- It is possible to cancel an acquired draft from the memory; to overwrite a new one, activate the "save" function again ' '.
- After saving the draft measurement, to carry out the combustion analysis, press the key ' '.

12.3 Measurements → Smoke



Smoke measurement with manual pump kit.

Smoke measurement with heated head.

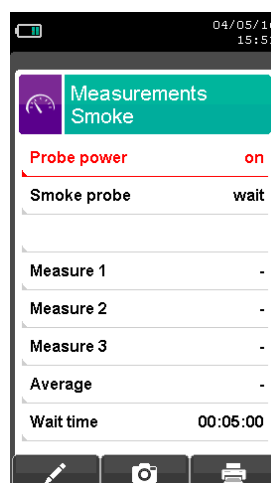
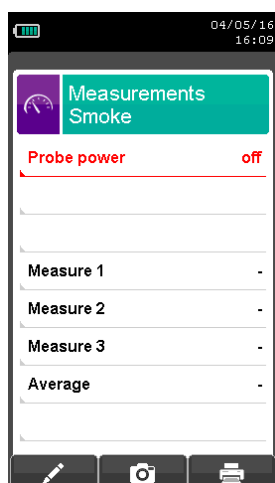

KEY	FUNCTION
	Activate the context keys shown on the display.
	Sets the "soot number" found by the device when measuring the carbon black.
	Also activates the context key located in the lower left side of the display.
	Returns to the previous screen.

CONTEXT KEY	FUNCTION
	Enters the modification mode for the selected parameter.
	Starts measurement (only when the heated head probe for smoke is used).
	Confirms the value entered.
	Saves, in the memory selected in the "Select Memory" menu, the values entered.
	Starts printing the paper print-out. See section 11.



- Perform the smoke measurements with the proper manual pump or with the heated head probe.

Enter the values found.

- The values of the carbon black that you want to save must be acquired before saving the analyses.

- To join the values of the carbon black to the measurements of the current analysis use the ' ' function.

- To print the paper print-out with the measurement of the carbon black, activate the ' ' function.

- It is possible to delete the values of the carbon black acquired in the memory by overwriting them by activating the ' ' function again.

- After saving the carbon black values, to carry out the combustion analysis, press the key ' '.



12.3.1 Smoke measurement with manual pump kit (optional)

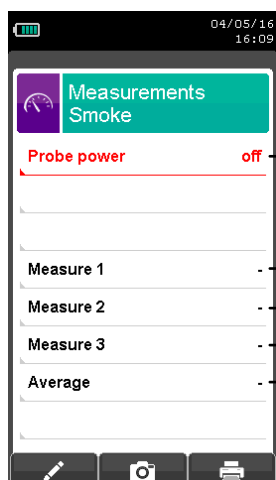

- When manual pump kit is used set to ' off ' the probe power supply.
- 1st measurement value, to be entered manually.
- 2nd measurement value, to be entered manually.
- 3rd measurement value, to be entered manually.
- Average value of the above measurements, automatically calculated by the instrument.

12.3.2 Test performance with the manual soot pump

Before using the product, please read this operating manual carefully and keep it ready to hand, when required.

Field of application

The soot pump serves for determining the smoke spot number of oil burning installations (diesel soot).

Basic safety instructions

!!! Be careful about the measures !!!

- Before using the soot pump, warm it up to room temperature.
- After approx. 10 measurements, check the withdrawal probe up to the valve for soot deposit and clean it. In regular intervals, this also applies for the other parts of the flue-gas pump (Maintenance of the pump).
- Occasionally test the soot pump for leaks (see: Testing the pump for leaks). It is recommended to keep the soot picture comparison scale always in its wrapper and thus clean.

!!! Ensure warranties!!!

- It is precondition, that the soot pump is exclusively used appropriate and according to the intended use.
- Do not apply force to the testing instrument. (It may not defend against it!)

Test operation

Sampling of soot

Before taking the soot sample, the burner should Already be in operation for at least 5 minutes.

- A. Insert the filter paper in the slot opening on the pump head and clamp it with a clockwise rotation of the probe head.
- B. Bring the probe tube through the measuring vent of the exhaust pipe in the middle of the flue-gas flow.
- C. **Perform 10 full suction strokes;** draw slowly and uniformly (suction stroke), shortly pause at the stop (pressure equalization), than move back fast. According to the prescription, 1.63 +/- 0.07dm³ exhaust gas are thereby drawn through the filter paper.
The operation time of the 10 strokes has to be 40-60 seconds.
- D. Release the probe head with a left-hand rotation and extract the filter paper stripe. A measuring spot with the corresponding coloring remains on the filter paper. For being able to determine the smoke spot number of a fireplace, at least 3 samples have to be taken! The smoke spot number than is averaged out of them (see: Determination of the smoke spot number).

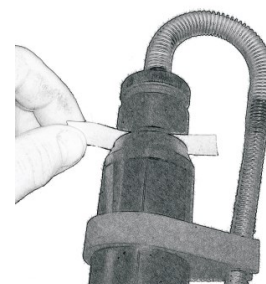

In case of a sluggish operation of the pump, lubricate the piston packing (see: Lubrication of the soot pump)!



Test for oil derivate

A. Test the measuring spot for oil-derivate. For that purpose, drop some solvent system acetone close to the measuring spot. If there is no grey coloration, no oil is contained. The sample is correct.

Otherwise

If there is a grey coloration of the measuring spot: The exhaust gas contains oil! Inspect the oil burning installation!

B. Hold the filter paper with the measuring spot behind the grey scales of the soot picture comparison scale until the spot appears fully in center and read off the smoke spot number. The shade of grey most looking similar to the measuring spot density shows the smoke spot number.

C. Now average over the smoke spot numbers of all samples withdrawn. This value, round up to the next whole number, is the value respectively the smoke spot number of the installation.

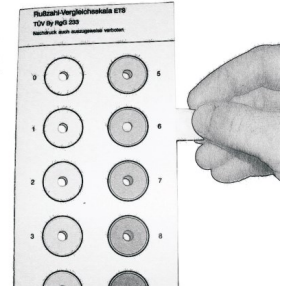

Maintenance

Cleaning of the soot pump

Remove lightly adhering soot particles:

- For this purpose, make some expeditious pump strokes with the pump, the probe head slightly drawn and no filter paper inserted. With it, lightly adhering dirt also peels away from the valve.

Disassembly of the soot pump:

- Unscrew the cylinder cap with left-hand rotation.
- Carefully pull the piston out of the cylinder. Pay attention not to damage the piston packing on the thread inside of the cylinder!

For cleaning the piston package, in no case take it off the piston rod!

- Unscrew the probe head with left-hand rotation.
- Screw off the valve using the enclosed key through left-hand rotation. Put the key securely into the borehole.

For removing lubricant residues, use only cleaning agents not affecting plastic material!

- Strongly effloresced piston rods may be cleaned with fine-grained sandpaper.
- Clean the pump components with a cloth or a suitable brush.

Lubrication of the sooth pump

Before lubricating the relevant parts of the soot pump, it has to be cleaned (see: Cleaning of the soot pump)!

For lubricating the pump use only the provided lubricating oil! Do not apply too much lubricating oil! Do not use lubricants containing mineral oil!

- Insert somewhat oil in the cylinder. Apply and distribute lubricating oil on the piston packing and than mount it.
- Move the piston in the cylinder until it is smooth running.
- Mount the remaining components.

Testing the pump for leaks

- Turn the probe head under slight pressure to the valve support (clockwise rotation / clamping position)
- Hold the pump with handle towards the body so, that the probe tube may be closed with the thumb (Of course you may also use other accessories for closing the probe tube.)
- Pull the pump piston on the handle out for approx. 3-5 cm and let it loose. The handle should spring back in its initial position: The pump is sealed.

or

- The handle does not spring back in its initial position: The pump is leak.

Possible causes:

- rubber hose defect
- valve / valve gasket is not OK
- crack in the piston packing



12.3.3 Smoke measurement with heated head probe (optional)



- When the heated head probe is used for smoke measurement set to ' on ' the probe power supply.
- Probe status: Wait (heating up) or Ready (probe is ready for measurement) or Measurement (acquisition).
- 1st measurement value, to be entered manually.
- 2nd measurement value, to be entered manually.
- 3rd measurement value, to be entered manually.
- Average value of the above measurements, automatically calculated by the instrument.
- Residual wait time.

12.3.4 Put into service of the smoke probe with heated head

- Unscrew the protective cap from the nozzle of the probe.
- Insert the nozzle on the probe grip, aligning the male connector of the nozzle with the female connector of the grip and screw the over-seal.

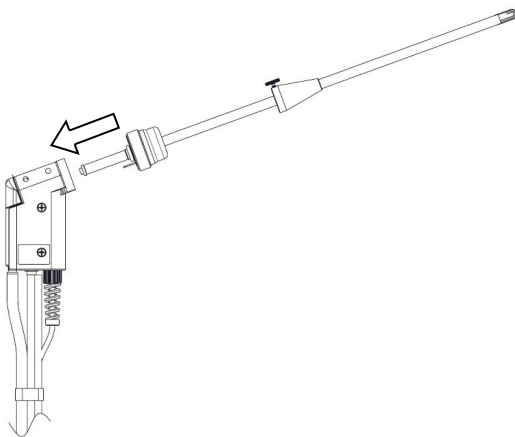

- Push the grip of the probe, so to open the where the paper black smoke filter will be inserted.
- The filter is to be inserted in the seat until it touches the bottom of the seat, as shown in the figure below.

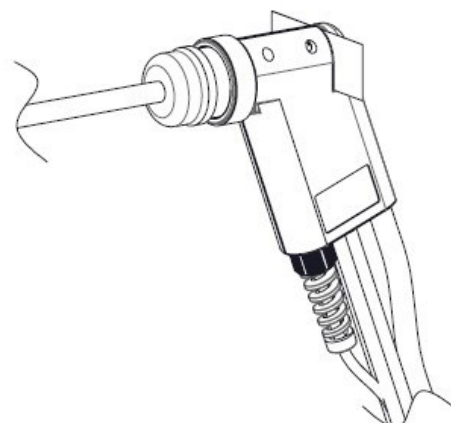
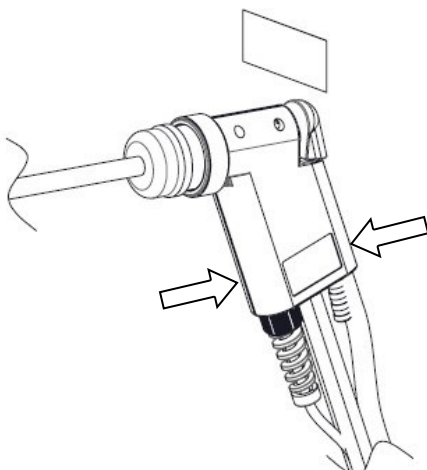

12.3.5 Connecting the heated head probe for smoke measurement

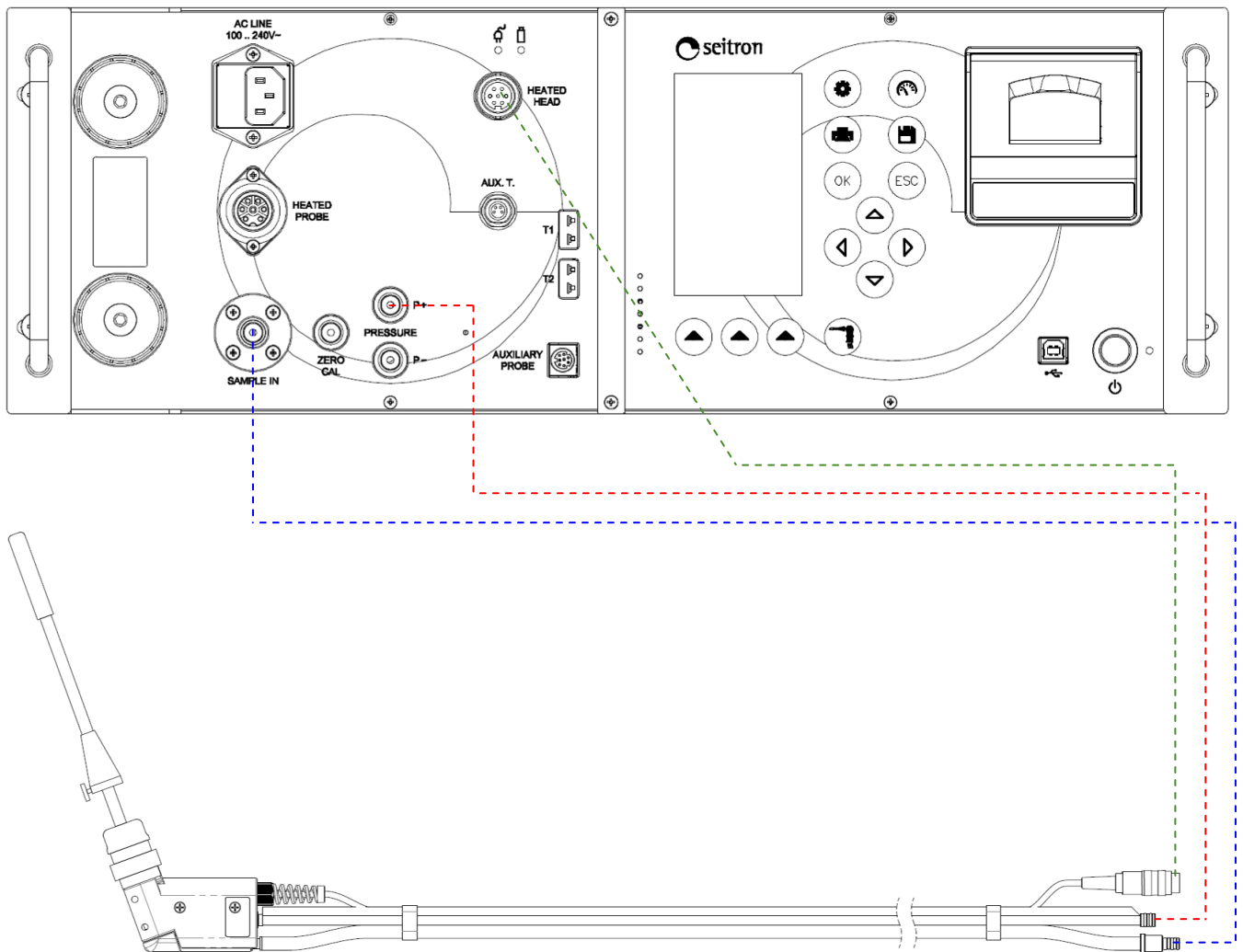

Heated head probe for smoke measurement: (AASX04 / AASX05).

12.3.6 Performing the test with the smoke probe

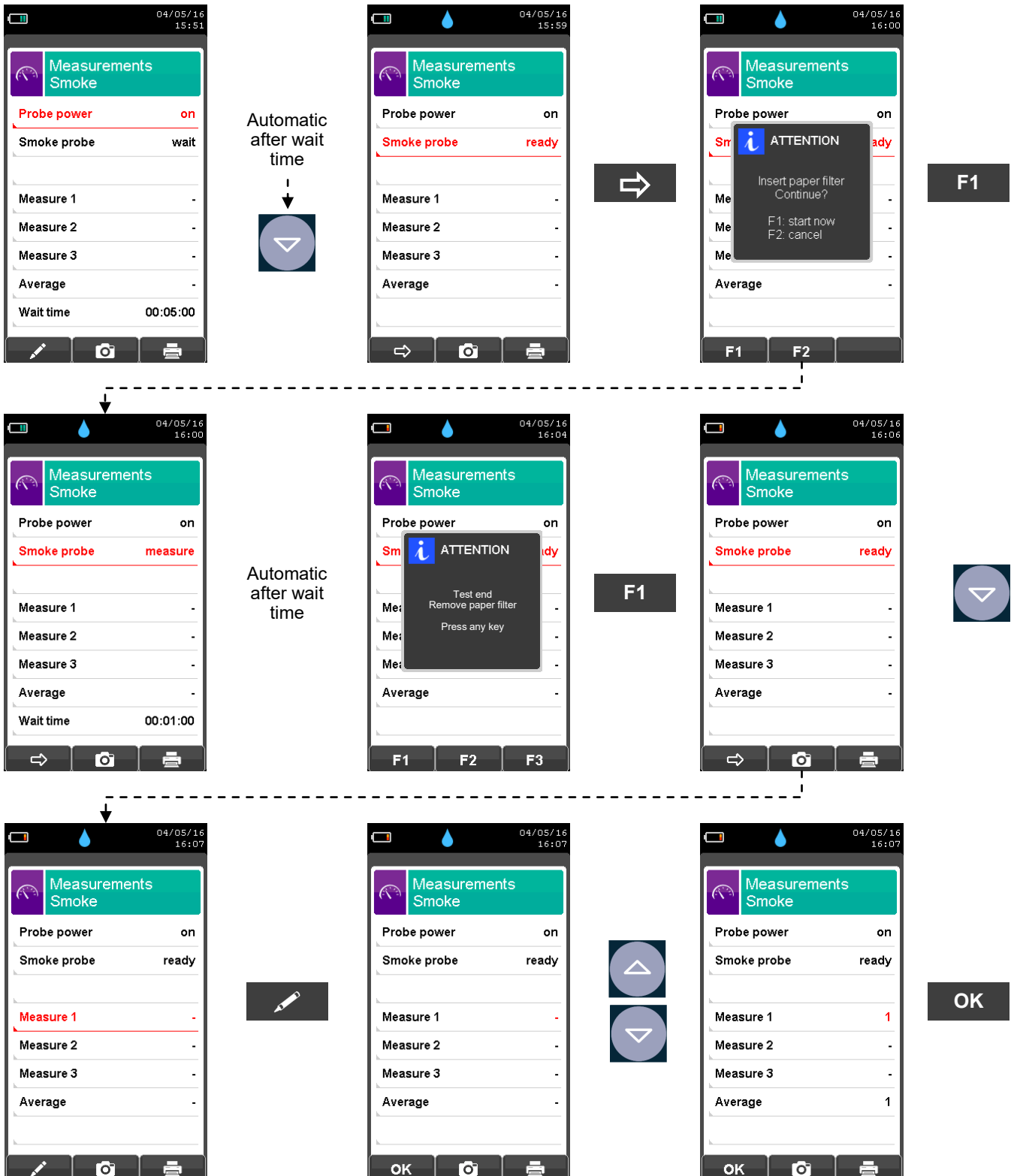

In order to perform additional measurements, please repeat all the described operations.

12.4 Measurements → Ambient CO

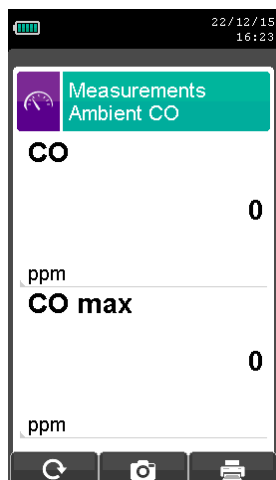





KEY	FUNCTION
	Activate the context keys shown on the display.
	Returns to the previous screen.

CONTEXT KEY	FUNCTION
	Updates the measurement.
	Saves, in the memory selected in the "Select Memory" menu, the data acquired.
	Starts printing the paper print-out. See section 11.



Make sure to perform to perform the autozero in a clean air environment (preferably outdoors), so that the ambient CO measurement is correct. It is advisable to turn on the instrument and wait for the autozero completion outside the area where the test is being performed.

- The values of the ambient CO that you want to save must be acquired before saving the analyses.
- To join the values of the ambient CO to the measurements of the current analysis use the '' function.
- To print the paper print-out with the measurement of the ambient CO, activate the '' function
- It is possible to delete a draft value acquired by the memory by overwriting it by activating the '' function again.
- After saving the draft values, to carry out the combustion analysis, press the key ''.



12.5 Measurements → Temperature

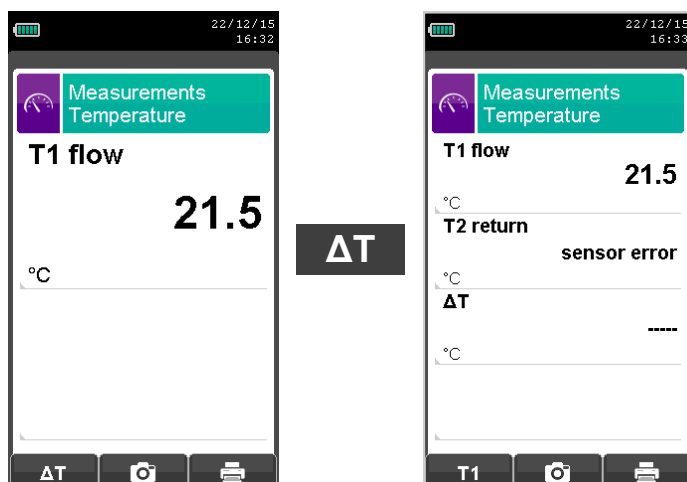

KEY	FUNCTION
	Activate the context keys shown on the display.
	Returns to the previous screen.

CONTEXT KEY	FUNCTION
	Accesses the acquisition of the temperature difference between the supply water (measured by the probe connected to the connector T1 of the device) and the return water (measured by the probe connected to the connector T2 of the device).
	Goes back to the visualization of the supply water temperature.
	Saves, in the memory selected in the "Select Memory" menu, the data acquired.
	Starts printing the paper print-out. See section 11.



12.6 Measurements → Pressure

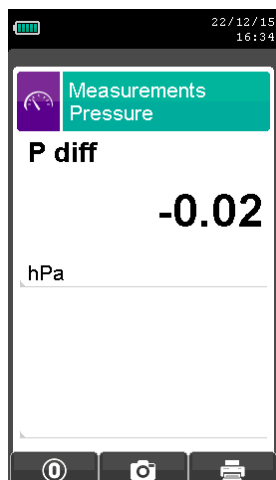

Measurement of the differential pressure by means of the internal pressure sensor (piezoresistive, temperature compensated).

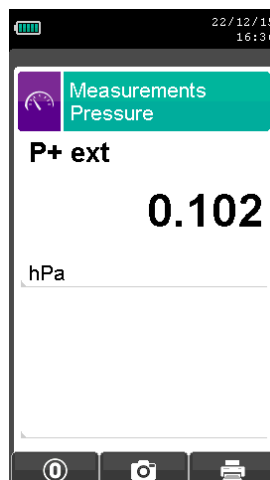

Measurement of the pressure by means of an external micromanometer.

KEY	FUNCTION
	Activate the context keys shown on the display.
	Returns to the previous screen.

CONTEXT KEY	FUNCTION
	Performs pressure zeroing.
	Saves, in the memory selected in the "Select Memory" menu, the data acquired.
	Starts printing the paper print-out. See section 11.

12.7 Measurements → Tightness test



Tightness test according UNI 7129-1: 2015 and UNI 11137: 2019 (when the instrument version so provides).

Tightness test according DVGW TRGI (when the instrument version so provides).

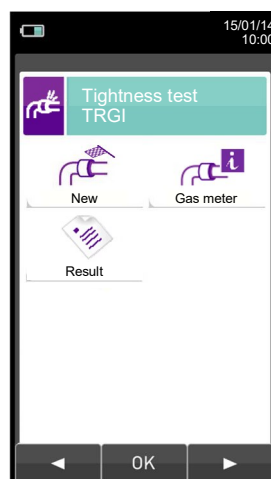
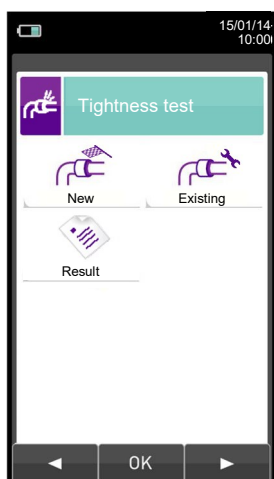

KEY	FUNCTION
	Activate the context keys shown on the display.
	Returns to the previous screen.

CONTEXT KEY	FUNCTION
	Selects the available parameters.
	Enters in the selected parameter setting.
	Selects the available parameters.

PARAMETER	DESCRIPTION
New	With this menu it is possible to perform a tightness test, in accordance with UNI 7129-1: 2015 (on new systems or systems that have been restored after a repair) or in accordance with DVGW TRGI 2008. SEE SECTION 12.8 or 12.10.
Existing	With this menu it is possible to perform a tightness test, in accordance with UNI 11137: 2019, on existing systems. SEE SECTION 12.9.
Gas meter	It is possible to enter the gas meter no. or location (4 rows up to 24 characters each) in accordance with DVGW TRGI 2008. This data will be printed on the header of the report. SEE SECTION 12.11.
Result	This menu allows the user to view and/or save the last test carried out. SEE SECTION 12.12.

12.7.1 Connecting the tightness test kit to the instrument.

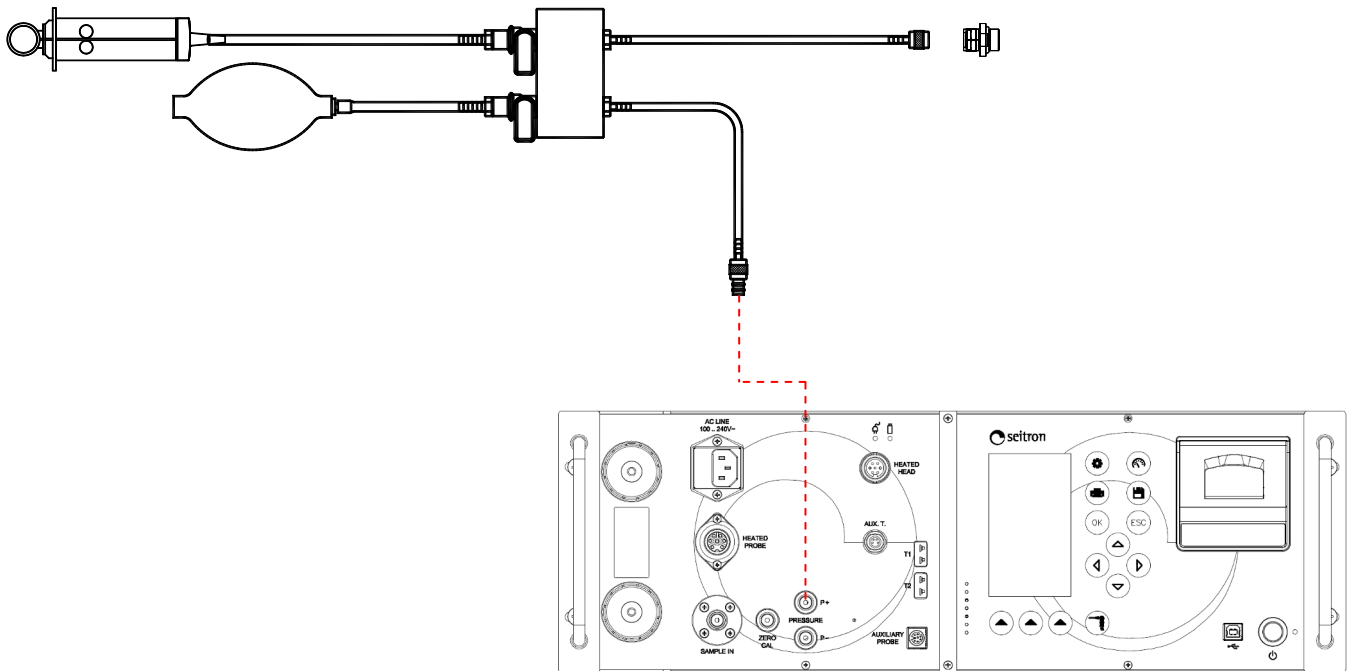

12.8 NEW PIPING: UNI 7129-1: 2015 STANDARD (when the instrument version so provides)

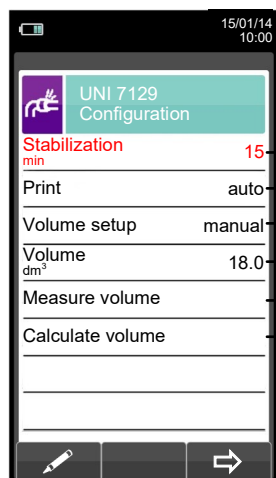

- ➔ Duration of the stabilization phase that can be set between 15 and 240 minutes
- ➔ Printing mode, that can be set as manual or automatic.
- ➔ Volume input mode can be set as 'manual' or 'default'.
- ➔ System volume, which can be set if known.
- ➔ Measures the volume of the system.
- ➔ Calculates the volume on the basis of the characteristics of the piping.

KEY	FUNCTION
	Activate the context keys shown on the display.
	Selects line; the selected line is displayed in red. In edit mode, it sets the desired value.
	Activates the context key located in the left side of the display.
	Returns to the previous screen. When in modify mode cancels the modification just made.

CONTEXT KEY	FUNCTION
	Enters the modification mode for the selected parameter.
	Goes to the next phase of the tightness test.
	Performs pressure zeroing.
	Interrupts the current phase.
	Repeats the tightness test.
	Saves, in the memory selected in the "Select Memory" menu, the data acquired.
	The tightness test has been saved.
	Starts printing the paper print-out.



Details of the test:

The standard UNI 7129-1: 2015 can be adopted for testing new piping systems or reconditioned ones.

This test requires to charge the piping up to a pressure between 100 hPa and 150 hPa, then wait for a stabilization which must last at least 15 minutes and required in order for the thermal effects caused by the test gas compression to fade out, and finally to test the piping tightness by analyzing the decay of pressure over time.

The maximum pressure decay measured, expressed as a function of the piping volume, must be smaller than the values shown in the following table:

Internal piping volume (litters)	Wait time (minutes)	Maximum pressure decay allowed (hPa)
$V \leq 100$	5	0,5
$100 < V \leq 250$	5	0,2
$250 < V \leq 500$	5	0,1

Table 1.

Chemist 900 allows the user to customize the stabilization phase through the following parameter:



WAIT TIME: it is the stabilization time and can be set by the user from 15 to 99 minutes. Please note that UNI 7129-1: 2015 standard requires a stabilization time of at least 15 minutes, anyway there is the possibility to skip stabilization by pressing '  ' button.

VOLUME SETUP: An accurate tightness test performed according to the UNI 7129-1: 2015 standard requires to know the piping volume.



Because this data is often unavailable, Chemist 900 splits the test from the beginning into two different paths:

Default: valid for systems with a volume under 100 dm^3 (litters), the most frequent, where it is not required to enter the value of the volume since it is assumed that the system has a volume of 100 dm^3 .

Manual: in this case it is necessary to set the volume of the system by entering the numeric value if known, or by calculating the amount as the sum of the contributions of the different sections of piping or, even, by assessing the measurement with a simple procedure that requires the injection into the system of a known amount of gas using a syringe.

If you use volume calculation, for each section of piping it is necessary to set the material, the nominal diameter and the length of the same. CHEMIST 900 calculates the volume of the section ("partial volume") and it adds it up, activating the context key '  ' (sum piping), to the calculation of the volume of the system. To correct any errors or to modify the current calculation, the subtraction operation is also allowed by activating the context key '  ' (subtract piping).

When the 'Volume measurement' option is selected instead, the procedure, described also in the flow charts of the tightness test according to UNI 7129-1: 2015, is described in the following steps:

- Close both valves of the piping kit supplied for the test.
- Connect the syringe to the kit opposite to the pump.
- Press the key relative to the context key '  '.
- Open the valve on the side where the syringe is connected, take exactly 100 ml (100 cc) of the gas present in the system.
- Wait for the stabilization of the pressure of the system. After a few seconds, the device displays the measured volume. The suggested value can be accepted by pressing the key '  ' and then modified by selecting, in "UNI 7129 Configuration" the line "volume".

It is also possible to repeat the measurement of the volume by pressing the key relative to the interactive function '  '.

Once the stabilization parameter has been set the user can proceed with the tightness test. By pressing the key relative to the context key '  ', first the test pressure is indicated, as required by law, then you can access a screen which displays the pressure reading of the inputs of the device.

After zeroing the device and putting the system under a pressure of at least 100 hPa, it is possible to start the tightness test by pressing the key relative to the context key '  ', which starts the stabilization phase. In the stabilization screen, the following values are displayed:



P: Actual pressure measured by the instrument, in the selected measurement unit.
ΔP1': Pressure variation in the last minute, updated every 10 seconds. This value gives a rough indication about the stabilization level reached in the piping system.

Wait time: Remaining time before the stabilization phase ends.

Once the stabilization phase is terminated the tightness test is started. This test is performed by observing how the pressure decays in time during a fixed 5 minutes interval, as stated in the applied standard.

During the tightness test phase the following values are displayed:

P1: Pressure measured at the beginning of the test.

P2: Pressure actually measured by the instrument.

ΔP: Pressure variation with respect to the initial value. In case the actual pressure is lower than the initial value (pressure is decreasing) this value has a negative sign.

Wait time: Remaining time of the tightness test.

After the tightness test, the results are displayed: the data displayed is as follows:

P1: Pressure measured at the beginning of the test.

P2: Pressure measured by the device.

ΔP: Pressure variation between the last instant and the first instant of the test. If the pressure decreased, it presents a negative value.

Result: Reports the test result:

tight when the pressure is within the limit of table 1.

leak when the pressure is outside the limit of table 1.

Positive pressure changes are symptom of a temperature change meanwhile the test is performed. Should this happen it is advisable to repeat the entire test.

operator if the Δ pressure is higher than +3 hPa it is operator's choice if repeat the test or not because the pressure and/or temperature conditions might have changed during the test.

12.8.1 CONFIGURATION OF TIGHTNESS TEST ACCORDING TO UNI 7129-1: 2015

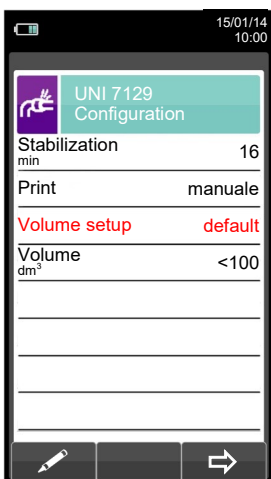
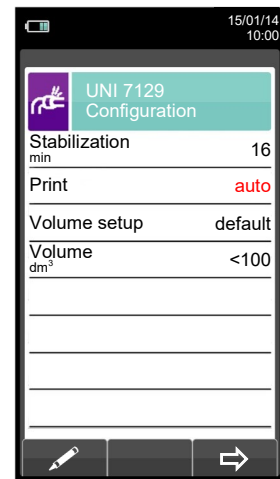
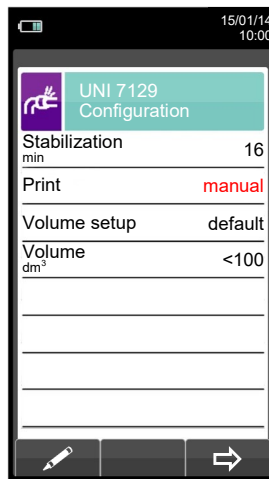
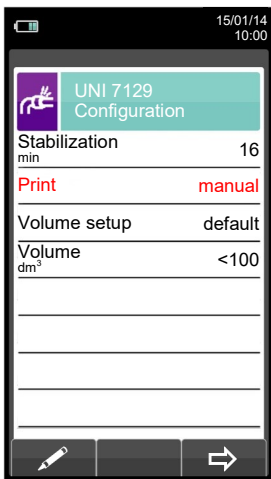
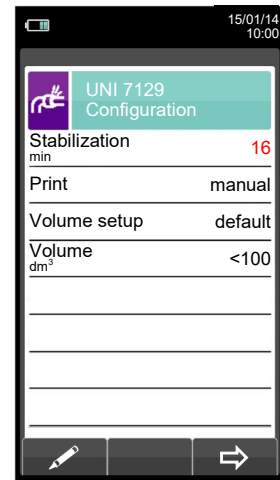
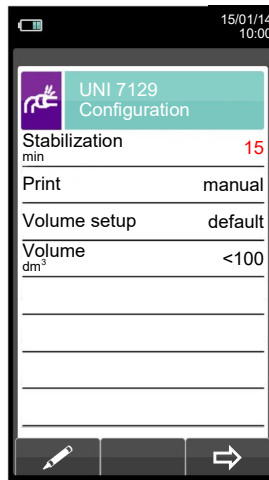
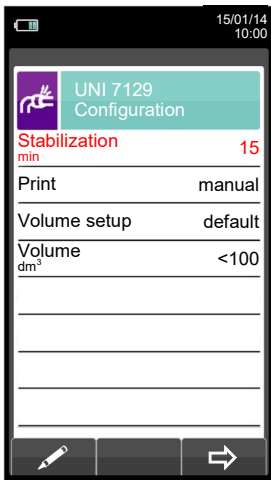

Starts the tightness test for systems up to 100 dm³ (liter)
([SEE SECTION 12.8.2](#)).



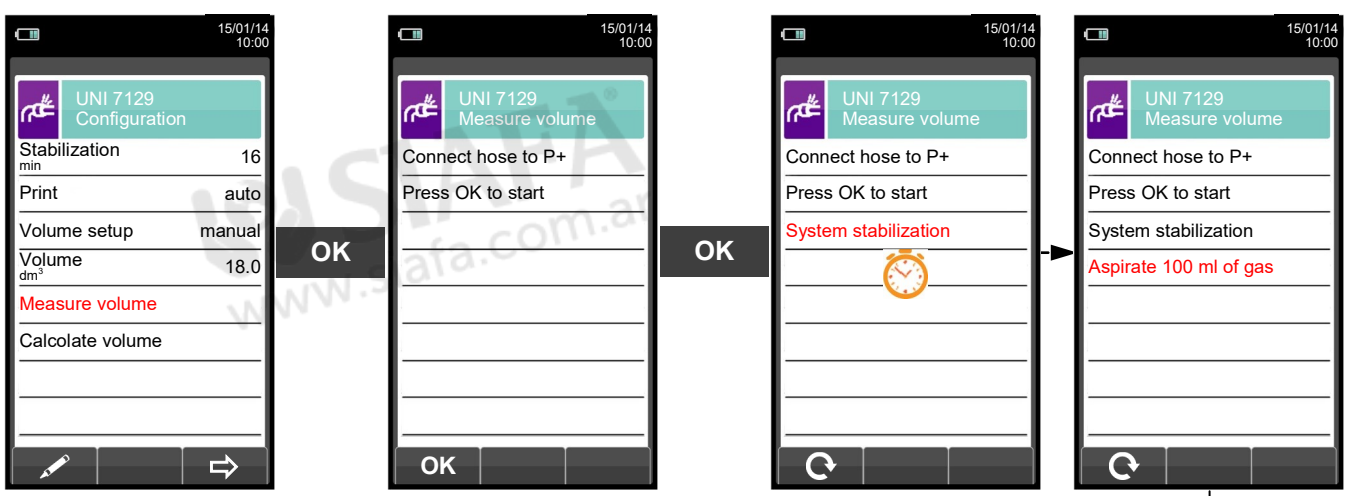

Alternatively





Take, with the syringe (that comes with the tightness test kit), 100 ml of gas.
If the volume measuring procedure of the system ends correctly, CHEMIST 900 automatically displays the measured volume, otherwise it requires another test.

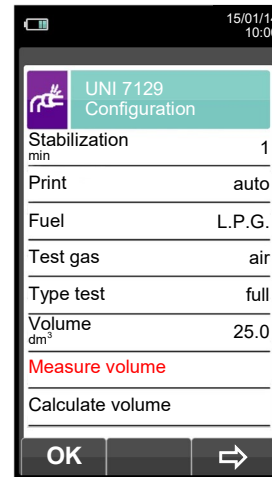
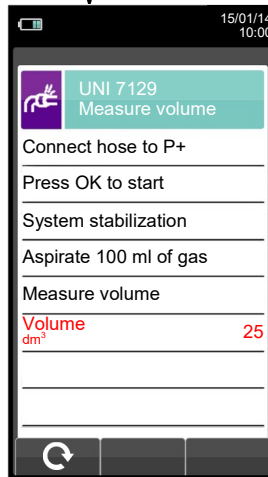

Starts the tightness test after measuring the volume (SEE SECTION 12.8.2).

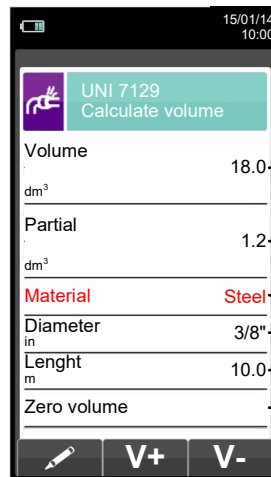
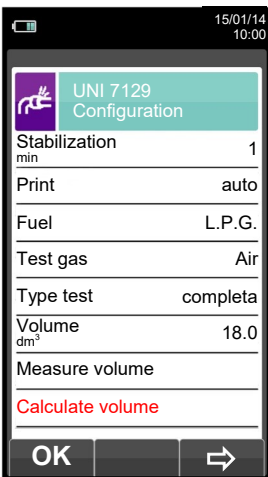

Total volume acquired.

Volume of the section of piping set below.

Sets the material of the section of piping.

Sets the nominal diameter of the section of piping.

Sets the length of the section of piping.

Zeroes the volume previously acquired.



Adds up the volume of the section of piping entered.

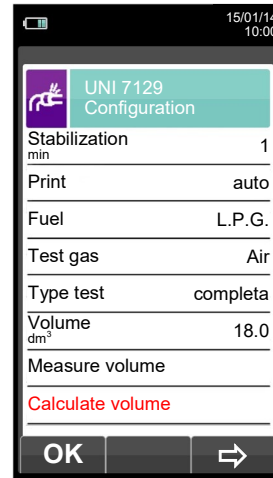
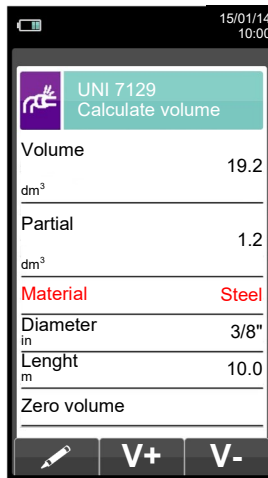

Starts the tightness test (SEE SECTION 12.8.2).



Subtracts the volume of the section of piping entered.

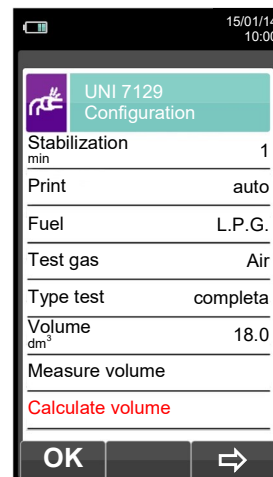
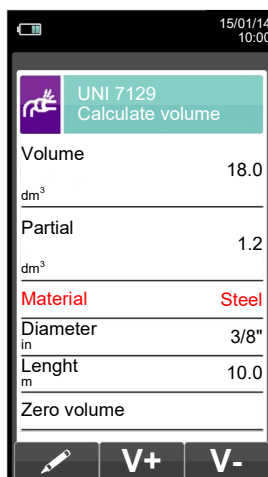

Starts the tightness test (SEE SECTION 12.8.2).

12.8.2 PERFORMING TIGHTNESS TEST ACCORDING TO UNI 7129-1: 2015

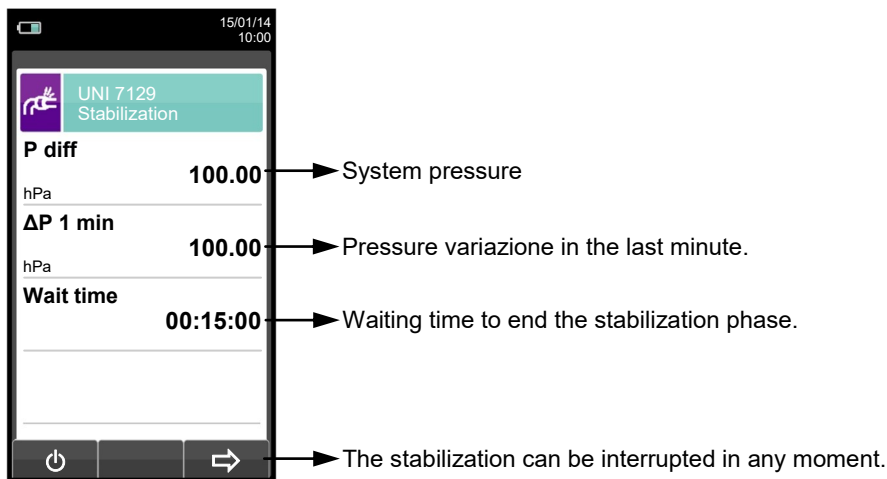

Automatically

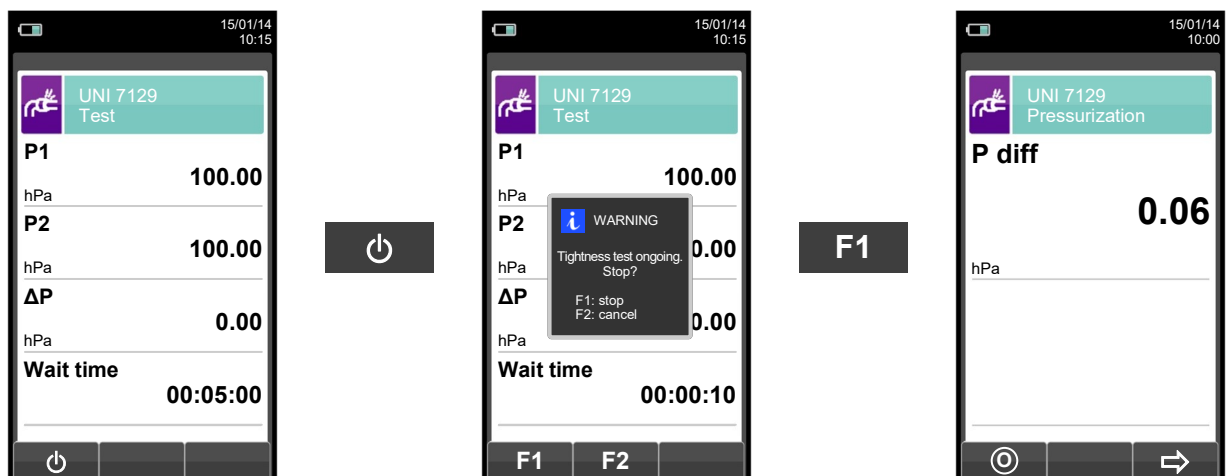

Automatically,
after 5 minutes.



NOTE: If, while configuring the tightness test the automatic printing mode has been selected, the tightness test is printed automatically.

Instead, if the manual printing mode has been selected (exemplified case), at the end of the tightness test the results are displayed and they can be saved and/or printed.

In this case proceed as follows:

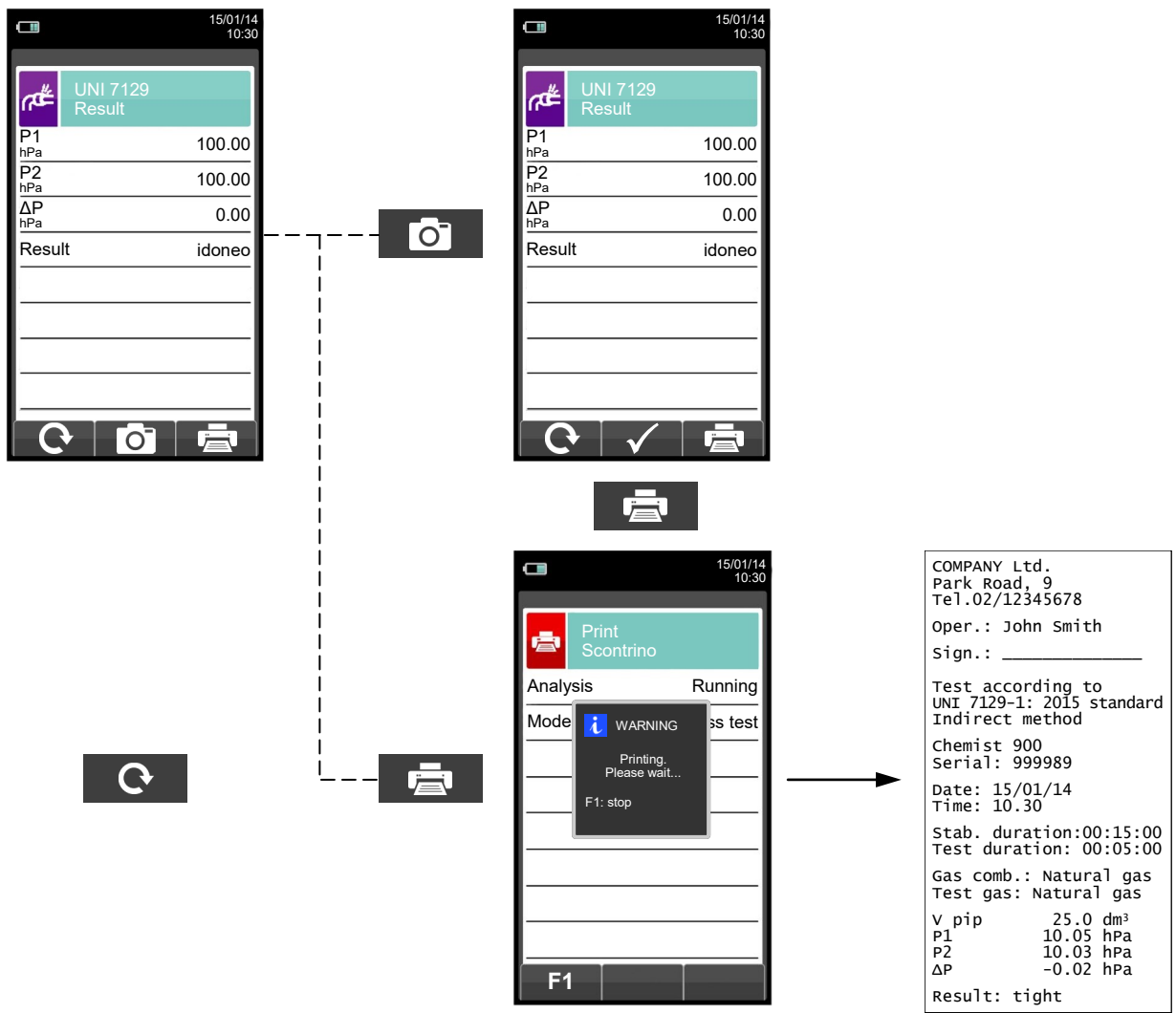

12.9 EXISTING OR RENEWED SYSTEM: UNI 11137: 2019 STANDARD. (when the instrument version so provides)



- System pipeline selection: inside or outside the building.
- Duration of the stabilization phase that can be set between 1..240 min.
- Printing mode, that can be set as manual or automatic.
- Fuel used in the system: L.P.G. - Natural gas.
- Gas used in the test: Air - fuel.
- Type of test to perform: preliminary (system volume <math>< 18.0\text{dm}^3</math>) - Complete.
- System volume, which can be set if known.
- Measures the volume of the system.
- Calculates the volume on the basis of the characteristics of the piping.

KEY	FUNCTION
	Activate the context keys shown on the display.
	Selects line; the selected line is displayed in red. In edit mode, it sets the desired value.
	Activates the context key located in the left side of the display.
	Returns to the previous screen. When in modify mode cancels the modification just made.

CONTEXT KEY	FUNCTION
	Enters the modification mode for the selected parameter.
	In "Calculate Volume" it adds up one or more sections of piping.
	In "Calculate Volume" it corrects any errors or modifies the current calculation by subtracting one or more sections of piping.
	- Confirms the element entered. - in "Measure Volume" it starts the volume measuring procedure. - in "Calculate Volume" it zeroes the volume acquired.
	Goes to the next phase of the tightness test.
	Performs pressure zeroing.
	Interrupts the current phase.
	- Repeats the tightness test. - In "Measure Volume" it repeats the volume measuring procedure.
	Saves, in the memory selected in the "Select Memory" menu, the data acquired.
	The tightness test has been saved.
	Starts printing the paper print-out.



Details of the test:

The UNI 11137: 2019 standard is applied to the VII species operating systems, defining the leakage limits depending on the fact that the leak is located inside or outside the building

This test requires to charge the piping up to the test pressure, then wait for an unspecified stabilization time until the thermal effects caused by the test gas compression are nulled, and then calculate the amount of the possible leakage from the measure of the pressure decays in 1 minute time.

If the preliminary test is performed using LPG test gas and combustible test gas, the evaluation of the leakage entity, performed through the pressure decay measurement, occurs within 2 minutes and 30 seconds.

The test pressure should be as close as possible as the reference conditions following explained.

REFERENCE CONDITIONS: According to the combustible gas to be used in the piping, the tightness test must be performed in one of the following reference conditions:

Methane:	Reference pressure for test with supply gas	2200 Pa
	Test pressure with air	2200 Pa
L.P.G.:	Reference pressure for test with supply gas	3000 Pa.
	Test pressure with air	3000 Pa.

CHEMIST 900 allows the user to customize the stabilization phase:

STABILISATION: the stabilization phase duration can be set in the 1 .. 99 minutes range.

As the UNI 11137: 2019 standard does not prescribe any stabilization duration, the factory setting for this value is borrowed from the UNI 7129-1: 2015 standard, which requires a minimum stabilization time of 15 minutes.

The waiting time can however be interrupted by activating the context key '  ' even if the interval is not over.

The tightness test performed according to the UNI 11137: 2019 standard requires the input of some data regarding the piping system and the test conditions, as described in the following.

SYSTEM: Performing the tightness test according to UNI 11137: 2019 requires to set the system part which it is intended to verify: Internal or External to the building.

COMBUSTIBLE GAS: consider that the amount of the leakage is strictly related to the nature of the gas under pressure. When the tightness of a piping has to be evaluated it is mandatory to specify the family to which the gas belongs: Methane or L.P.G.



TEST GAS: again the amount of the leakage is related to the nature of the gas under pressure, therefore it is mandatory to specify the type of the gas used: Natural Gas, L.P.G. or air. Please note that the gas used for the test could also be different from the gas to be used in the plant and could even be a not flammable gas.

TYPE OF TEST: An accurate tightness test performed according to the UNI 11137: 2019 standard requires to know the piping volume.

Because this data is often unavailable, CHEMIST 900 splits the test from the beginning into two different paths:

Preliminary: valid for systems with a volume under 18 dm³ (liters), the most frequent, where it is not required to enter the value of the volume since it is assumed that the system has a volume of 18 dm³.

Complete: in this case it is necessary to set the volume of the system by entering the numeric value if known, or by calculating the amount as the sum of the contributions of the different sections of piping or, even, by assessing the measurement with a simple procedure that requires the injection into the system of a known amount of gas using a syringe.

If you use volume calculation, for each section of piping it is necessary to set the material, the nominal diameter and the length of the same. CHEMIST 900 calculates the volume of the section ("partial volume") and it adds it up, activating the context key '  ' (sum piping), to the calculation of the volume of the system. To correct any errors or to modify the current calculation, the subtraction operation is also allowed by activating the context key '  ' (subtract piping). When the 'Volume measurement' option is selected instead, the procedure, described also in the flow charts of the tightness test according to UNI 11137: 2019, is described in the following steps:

- Close both valves of the piping kit supplied for the test.
- Connect the syringe to the kit opposite to the pump.
- Press the key relative to the context key '  '.
- Open the valve on the side where the syringe is connected, take exactly 100 ml (100 cc) of the gas present in the system.



- Wait for the stabilization of the pressure of the system. After a few seconds, the device displays the measured volume. The suggested value can be accepted by pressing the key '  ' and then modified by selecting, in "UNI 11137 Configuration" the line "volume".



It is also possible to repeat the measurement of the volume by pressing the key relative to the interactive function '  '.

Table volumes:

Examples relating to the various lengths of indoor systems, capacity approximately corresponding to 18dm³, depending on the material and the diameter of the fuel gas adduction pipe.

Steel		Copper / Multilayer/ Polyethylene	
Diameter	Length (m)	Internal diameter (mm)	Length (m)
1/2"	82 (68)	10	228 (190)
3/4"	49 (40)	12	160 (133)
1"	28 (23)	14	116 (97)
1 1/4"	17 (14)	16	90 (75)
		19	64 (53)
		25	37 (31)
		26	34 (28)
		34	20 (17)

Note: When the measurement group can not be excluded from the test, the indicative length of the plant is given in brackets.

Once the stabilization mode has been defined and the required data has been entered, you can proceed with the tightness test. By pressing the key relative to the context key '  ', first the test pressure is indicated, as required by law, then you can access a screen which displays the pressure reading of the inputs of the device. After zeroing the device and putting the system under a pressure of at least 100 hPa, it is possible to start the tightness test by pressing the key relative to the context key '  ', which starts the stabilization phase. In the stabilization screen, the following values are displayed:

P diff: Actual pressure measured by the instrument, in the selected measurement unit.

ΔP 1 min: Pressure variation in the last minute, updated every 10 seconds. This value gives a rough indication about the stabilization level reached in the piping system.

Wait time: Remaining time before the stabilization phase ends.

When the stabilization phase is over, the system tightness test evaluation is performed by measuring the pressure decay in a non-editable time interval of 1 minute for each setting, except when the preliminary test with LPG and combustible gas is performed; in this case the time interval is 2 minutes and 30 seconds, as required by the standard.

During the tightness test phase the following values are displayed:

P1: Pressure measured at the beginning of the test

P2: Pressure actually measured by the instrument

ΔP: Pressure variation with respect to the initial value. In case the actual pressure is lower than the initial value (pressure is decreasing) this value has a negative sign.

Wait time: Remaining time before the Test phase ends.

Once the test has finished, the results are displayed; the data displayed is as follows:

P1: Pressure measured at the beginning of the test

P2: Pressure measured by the device.

ΔP: Pressure variation between the last instant and the first instant of the test. If the pressure decreased, it presents a negative value.

Qtest: Is the calculated leakage measured in dm³/h according to the conditions under which the test has been performed, i.e. the gas used for the test as well as the final pressure measured during the test.

Qref: is the calculated leakage measured in dm³/h according to the reference conditions described in the standard, it is related to the gas to be used in the piping as well as to the reference pressure.



Result: is the result of the tightness test.

Compliant (piping suitable for operation): the plant is authorized to operate without restrictions or intervention.

Compl. 30 DD (piping temporarily suitable for operation): the system is authorized to operate only for the time needed for the maintenance of the pipe in order to fix the leakage problem, and in any case for no more than 30 days after the testing day. Once the fixing has been completed the piping must be tested again for its tightness according to the UNI 7129 standard.

Non compliant (not suitable for operation): in this situation the measured leakage is such that the piping is not suitable for operation and must immediately be placed out of order. Once the leakage problem has been fixed the piping must be tested again for its tightness according to the UNI 7129 standard.

operator if the Δ pressure is higher than +3 hPa it is operator's choice if repeat the test or not because the pressure and/or temperature conditions might have changed during the test.

On the table below are shown the leakage limits according to standard UNI 11137: 2019:

RESULT	LEAKAGE POSITION	METHANE LIMIT	LPG LIMIT
Compliant	Inside and outside of the building	Up to 1 dm ³ /h	Up to 0.4 dm ³ /h
Compliant 30 days	Inside the building	1 dm ³ /h < Qref ≤ 5 dm ³ /h	0,4 dm ³ /h < Qref ≤ 2 dm ³ /h
	Outside the building	1 dm ³ /h < Qref ≤ 10 dm ³ /h	0,4 dm ³ /h < Qref ≤ 4 dm ³ /h
Non compliant	Inside the building	≥ 5 dm ³ /h	≥ 2 dm ³ /h
	Outside the building	≥ 10 dm ³ /h	≥ 4 dm ³ /h

12.9.1 CONFIGURATION OF TIGHTNESS TEST ACCORDING TO UNI 11137: 2019



The image displays three sequential screenshots of a mobile application interface for configuring a tightness test. Each screen shows the date and time as 15/01/14 10:00 and the title 'UNI 11137 Configuration'. The configuration parameters are: Plant (int/external), Stabilization min (1), Print (auto), Fuel (L.P.G.), Test gas (Air), Type test (preliminary), and Volume (dm³, <18.0). The first screen shows 'Plant' set to 'int'. The second screen shows the same configuration with navigation arrows. The third screen shows 'Plant' set to 'ext' and an 'OK' button.

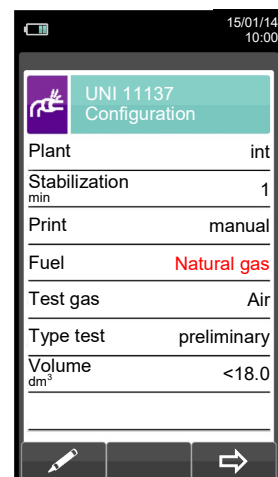
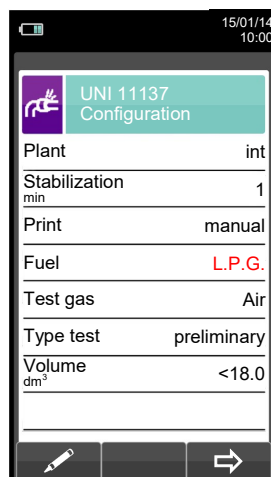
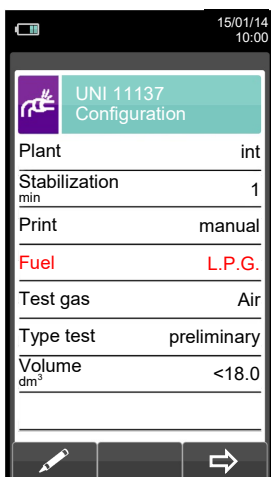
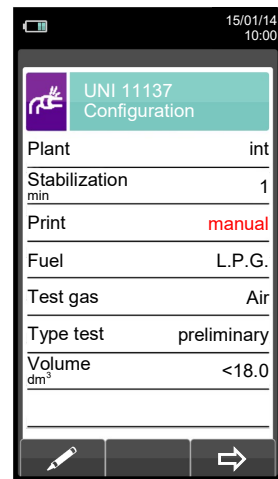
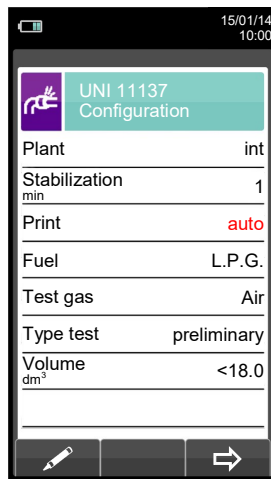
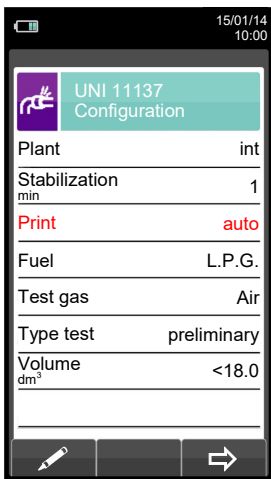
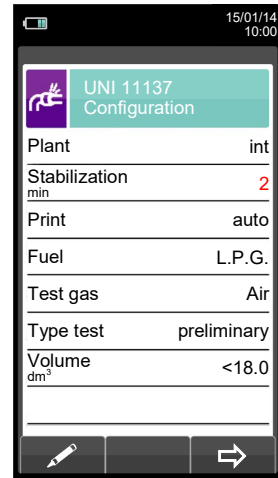
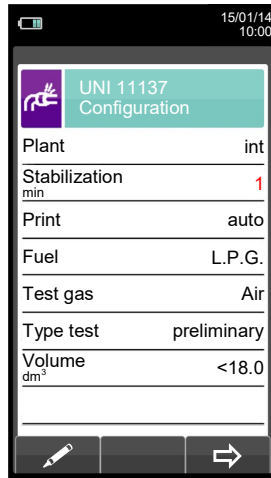
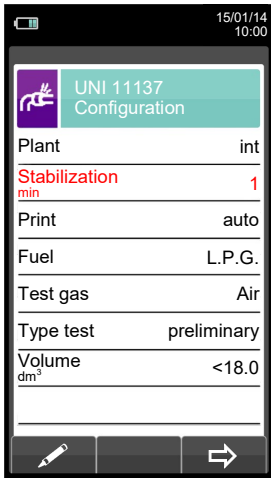

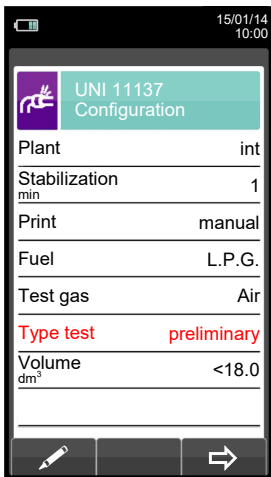
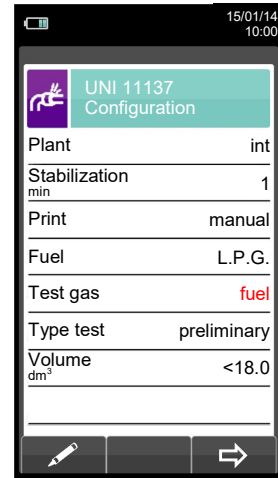
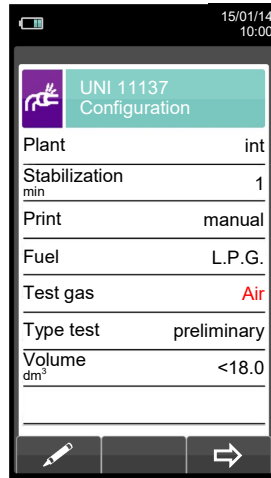
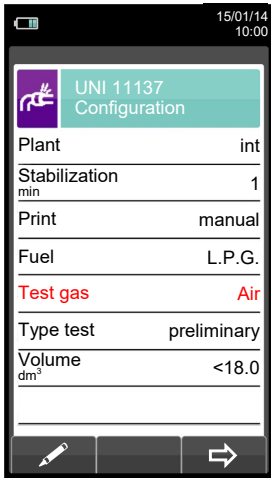

Starts the tightness test for systems up to 18 dm³ (see section 12.9.2).

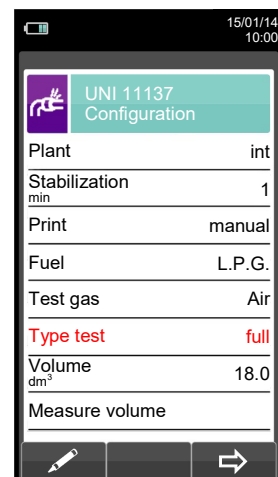
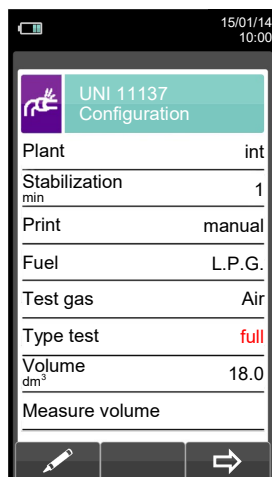
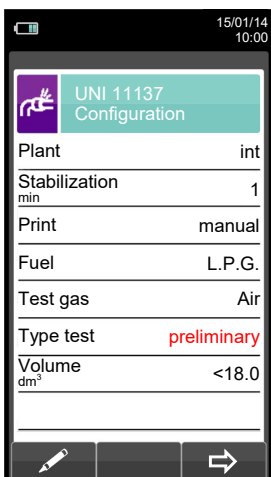

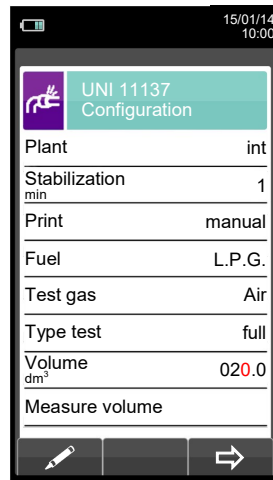
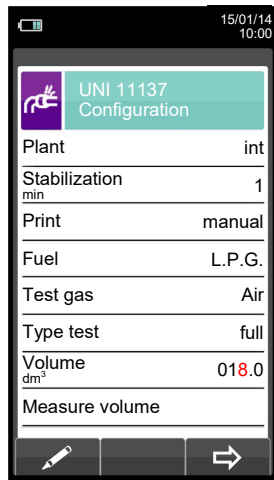
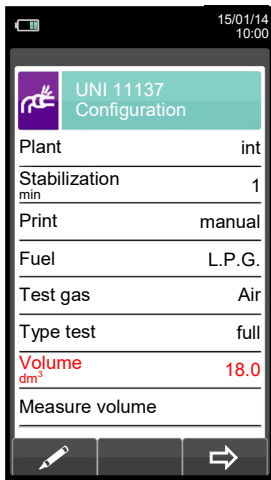

Starts the tightness test for systems with a known volume (see section [12.9.2](#)).

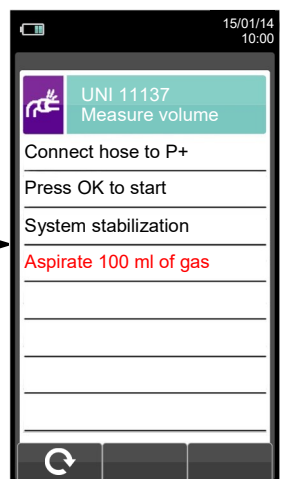
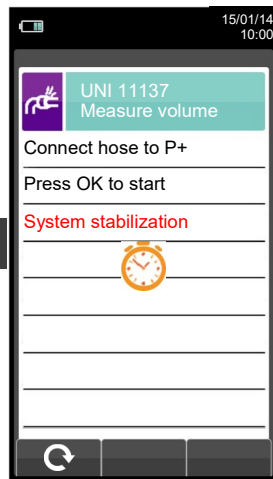
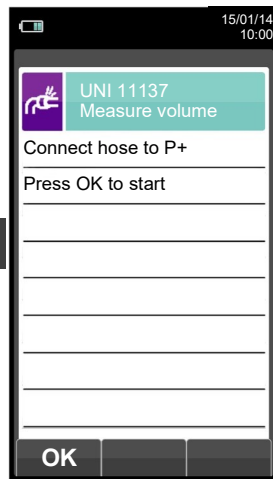
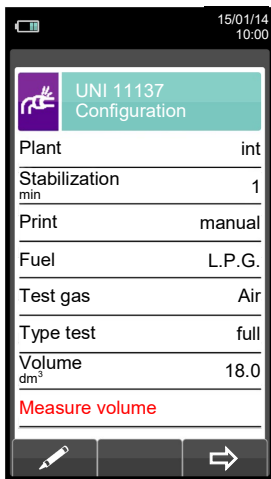

Alternatively



Take, with the syringe (that comes with the tightness test kit), 100 ml of gas.
If the volume measuring procedure of the system ends correctly, the instrument automatically displays the measured volume, otherwise it requires another test.

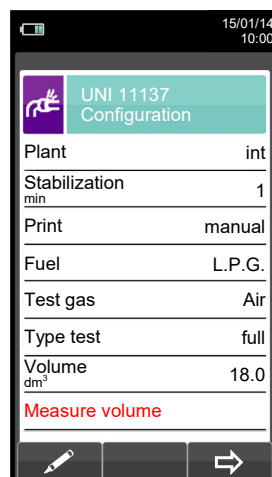
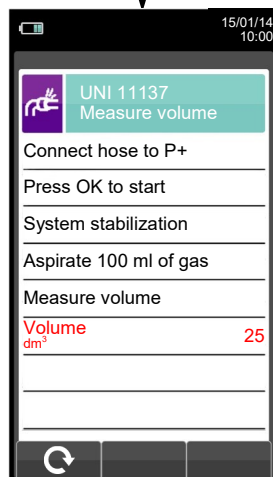

Starts the tightness test after measuring the volume (see section [12.9.2](#)).

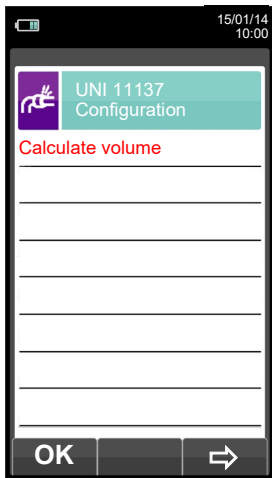

OK

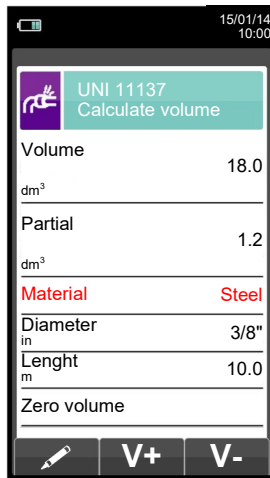

- Total volume acquired.
- Volume of the section of piping set below.
- Sets the material of the section of piping.
- Sets the nominal diameter of the section of piping.
- Sets the length of the section of piping.
- Zeroes the volume previously acquired.

V+ Adds up the volume of the section of piping entered.

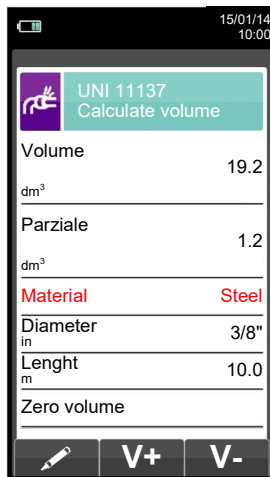

ESC

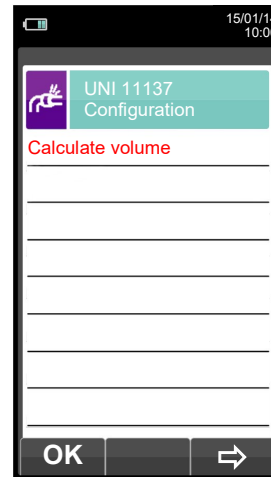

→

Starts the tightness test ([see section 12.9.2](#)).

V- Subtracts the volume of the section of piping entered.



ESC

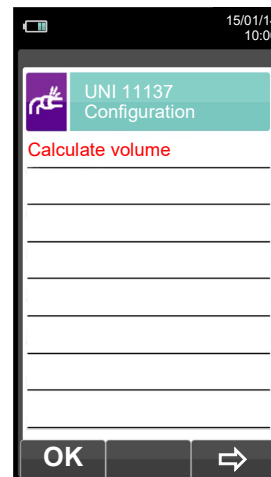

→

Starts the tightness test ([see section 12.9.2](#)).

12.9.2 PERFORMING THE TIGHTNESS TEST ACCORDING TO UNI 11137: 2019

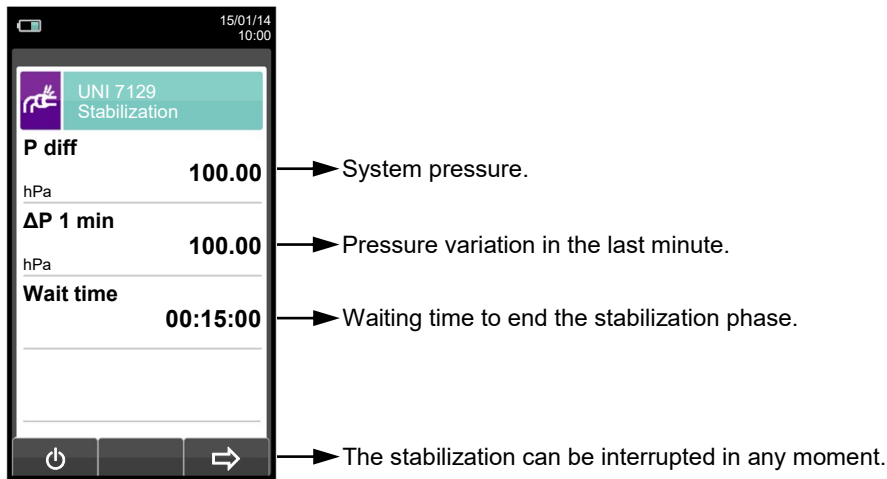
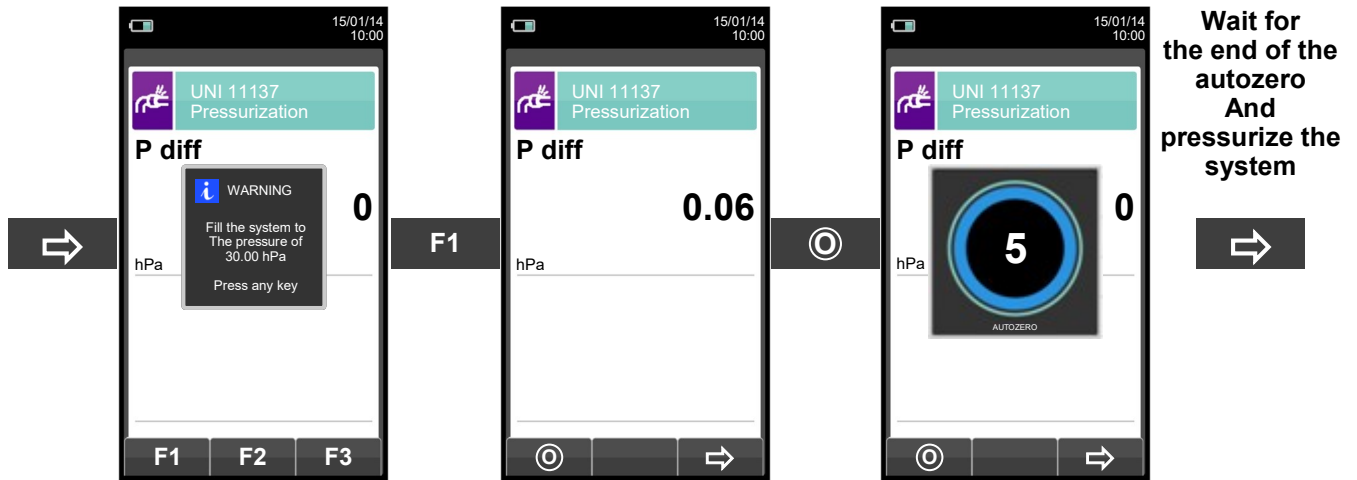

Automatically

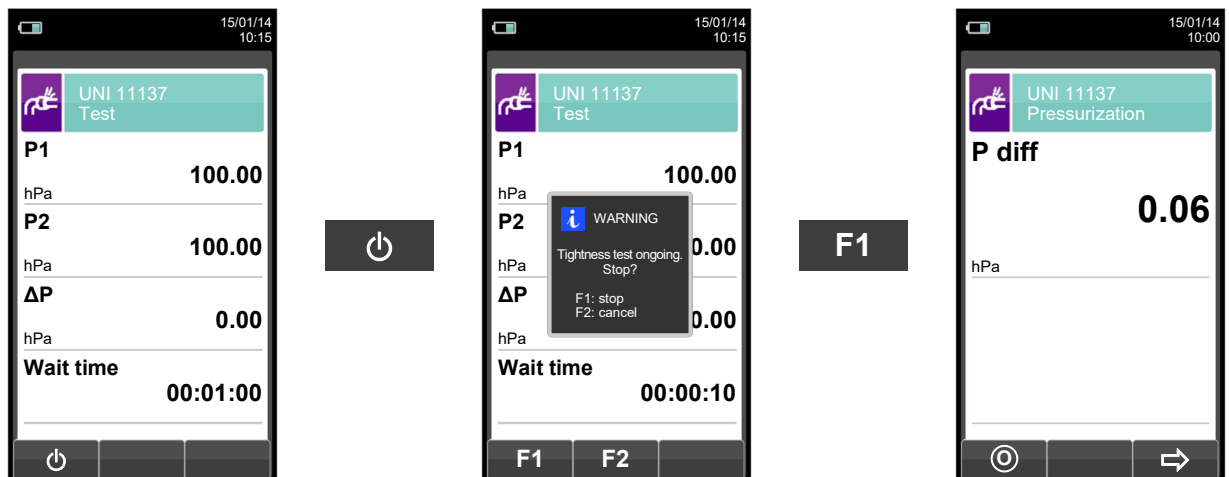



NOTE: If, while configuring the tightness test the automatic printing mode has been selected, the tightness test is printed automatically.

Instead, if the manual printing mode has been selected (exemplified case), at the end of the tightness test the results are displayed and they can be saved and/or printed.

In this case proceed as follows:

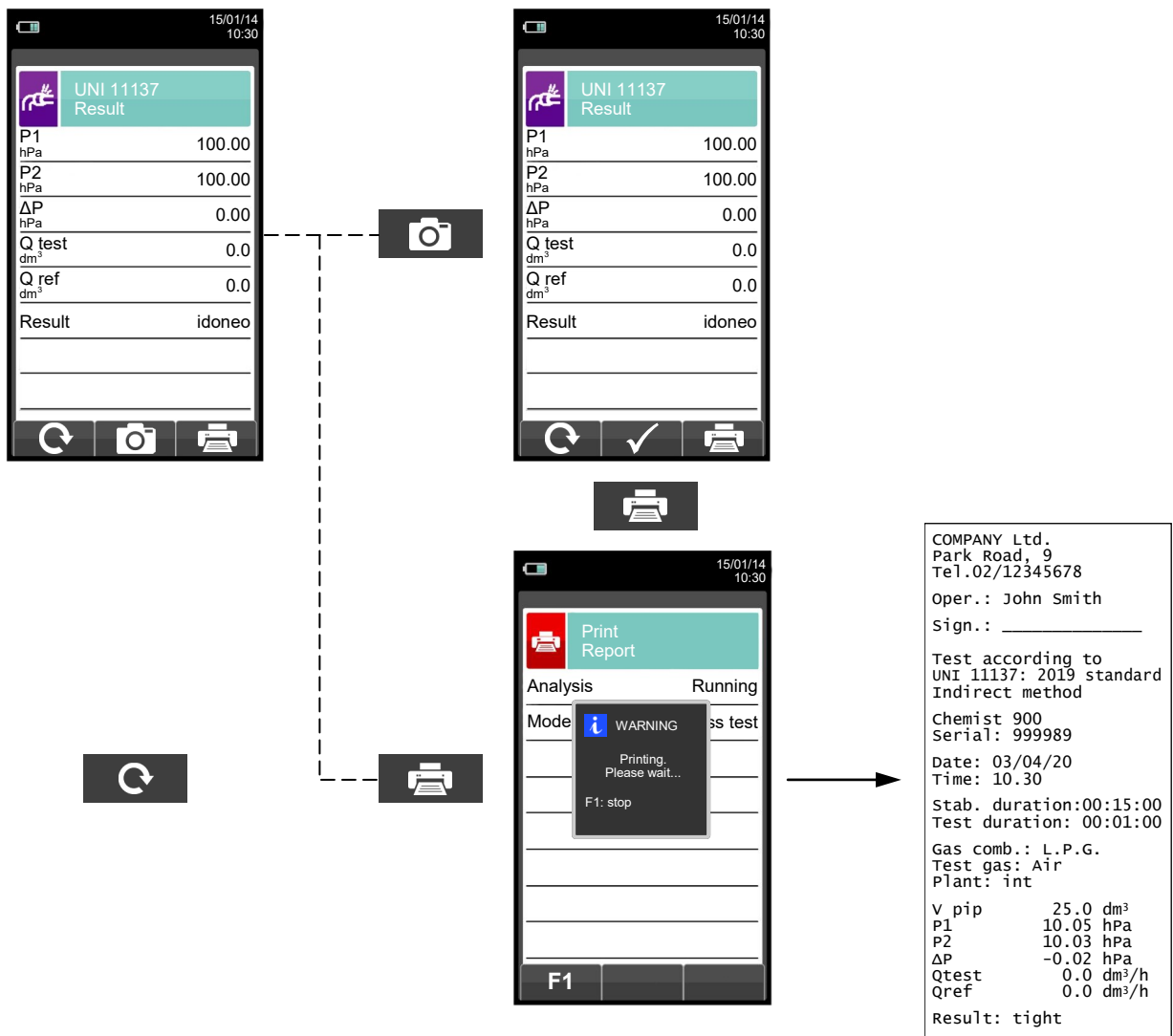

12.10 Measurements → Tightness test TRGI → New (when the instrument version so provides)

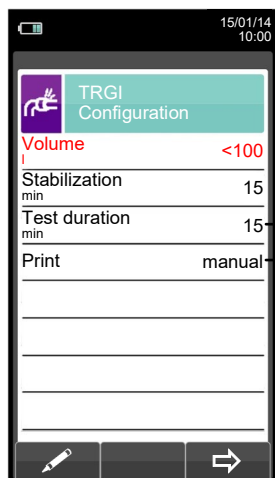

- ▶ Volume of the gas line <100 or 100..200 or >200 litre.
- ▶ Waiting time 15 ... 240 minutes.
- ▶ Duration time of test 15 ... 240 minutes.
- ▶ Print out test of the result (manual or automatic).

KEY	FUNCTION
	Activates the context keys shown on the display.
	Select line; the selected line is displayed in red. In edit mode, it is the desired value.
	Enters the selected parameter setting.
	Returns to the previous screen. When in modify mode cancels the modification just made.

CONTEXT KEY	FUNCTION
	Enters the modification mode for the selected parameter.
	Goes to the next phase of the tightness test.
	Performs pressure zeroing.
	Interrupts the current phase.
	Repeats the tightness test.
	Saves, in the memory selected in the "Select Memory" menu, the data acquired.
	Tightness test has been saved.
	Starts printing the paper print-out.



Details of the test:

With the flue gas analyzer CHEMIST 900 (according to the model) it is possible to test gas lines (DVGW TRGI 2008).

This test procedure is valid for gas lines with maximum operating pressure of 100 mbar:

The Standard DVGW TRGI 2008 is valid for new or after service existing gas lines. The tightness test uses a test pressure of 150mbar (test gas: air) all other parameter have to be selected according the gas line volume: waiting time and time duration for the test (time duration were the gas line is under pressure with 150 mbar).

Tightness test - DVGW TRGI 2008		
Volume of the gas line *	Waiting time before test starts	min. duration for the test
< 100 liter	10 min	10 min
≥ 100 l bis 200 liter	30 min	20 min
≥ 200 liter	60 min	30 min

* Benchmark

waiting time (Stabilization phase): You can edit manually the waiting time according to the volume of the gas line before you start the test procedure. The range is variable from 10 ... 99 minutes.

P: Current pressure measured when waiting time started.

ΔP1: Current pressure difference.

wait time: Time to stabilize the pressure in the gas line, the pressure must be higher than 150 mbar. On the display is the timer shown (count backwards).

Minimum duration time of tightness test according to the volume of the gas line: **duration time**

Waiting time according to the volume of the gas line: **wait time**

After the waiting time is finished the tightness test can start.

During the tightness test the following values measured for the duration time of the test will shown at the display:

P1: Pressure measured at the moment the tightness test begins (minimum 150 mbar).

P2: Current measured pressure.

ΔP: Pressure difference between start and finished test; negative value means pressure drop.

Result: tight or leak.

According to DVGW TRGI 2008 - no pressure drop is allowed!

It is possible to enter the data of the gas line (e.g. location, ...). They are shown later on the print out (report).

If duration time or waiting time varies (according the DVGW Standard) you can change the used time by yourself.

The loading and the serviceability test can not be tested with the flue gas analyzer CHEMIST 900, you have to use other measuring devices.

12.10.1 Performing a tightness test for a gas line up to 100 liter.

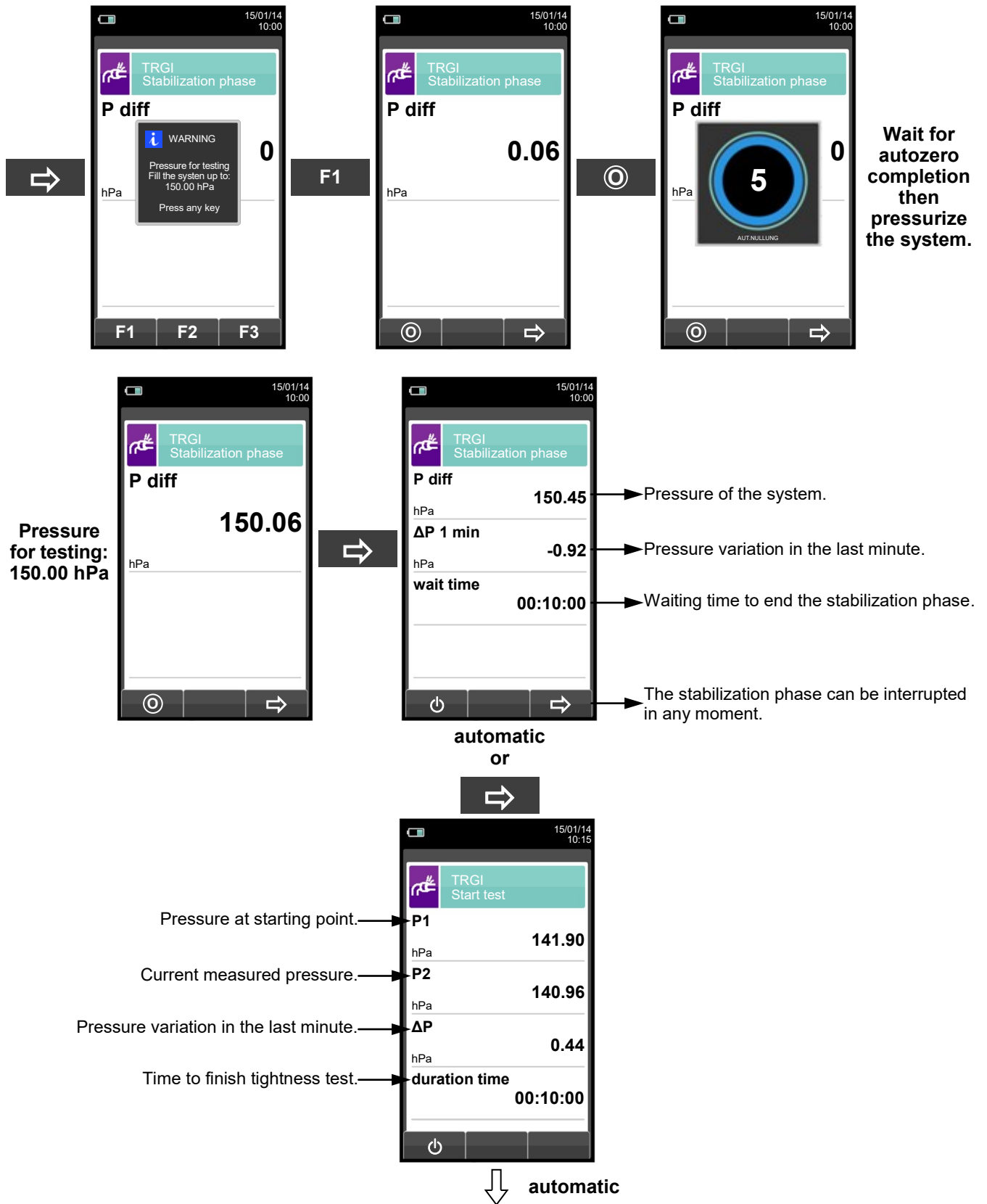

NOTE: If, while configuring the tightness test the automatic printing mode has been selected, the tightness test is printed automatically.

Instead, if the manual printing mode has been selected (exemplified case), at the end of the tightness test the results are displayed and they can be saved and/or printed. In this case proceed as follows.

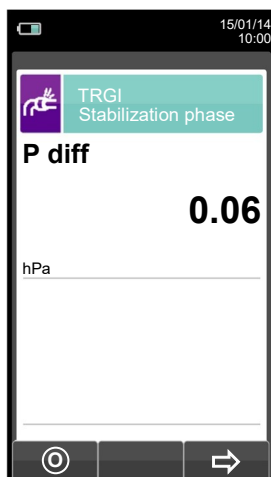
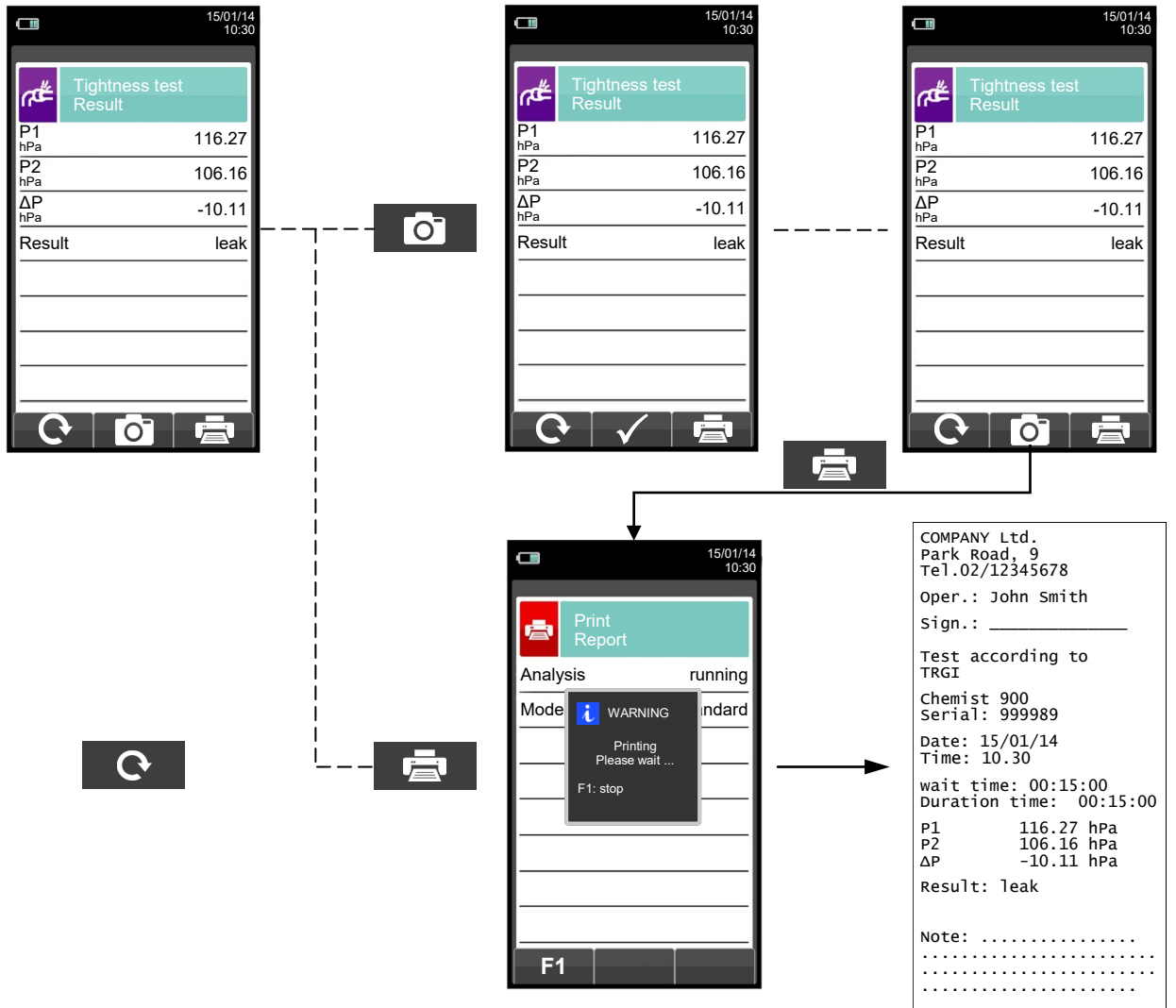

12.10.2 Performing a tightness test for a gas line up to 100 / 200 litre.

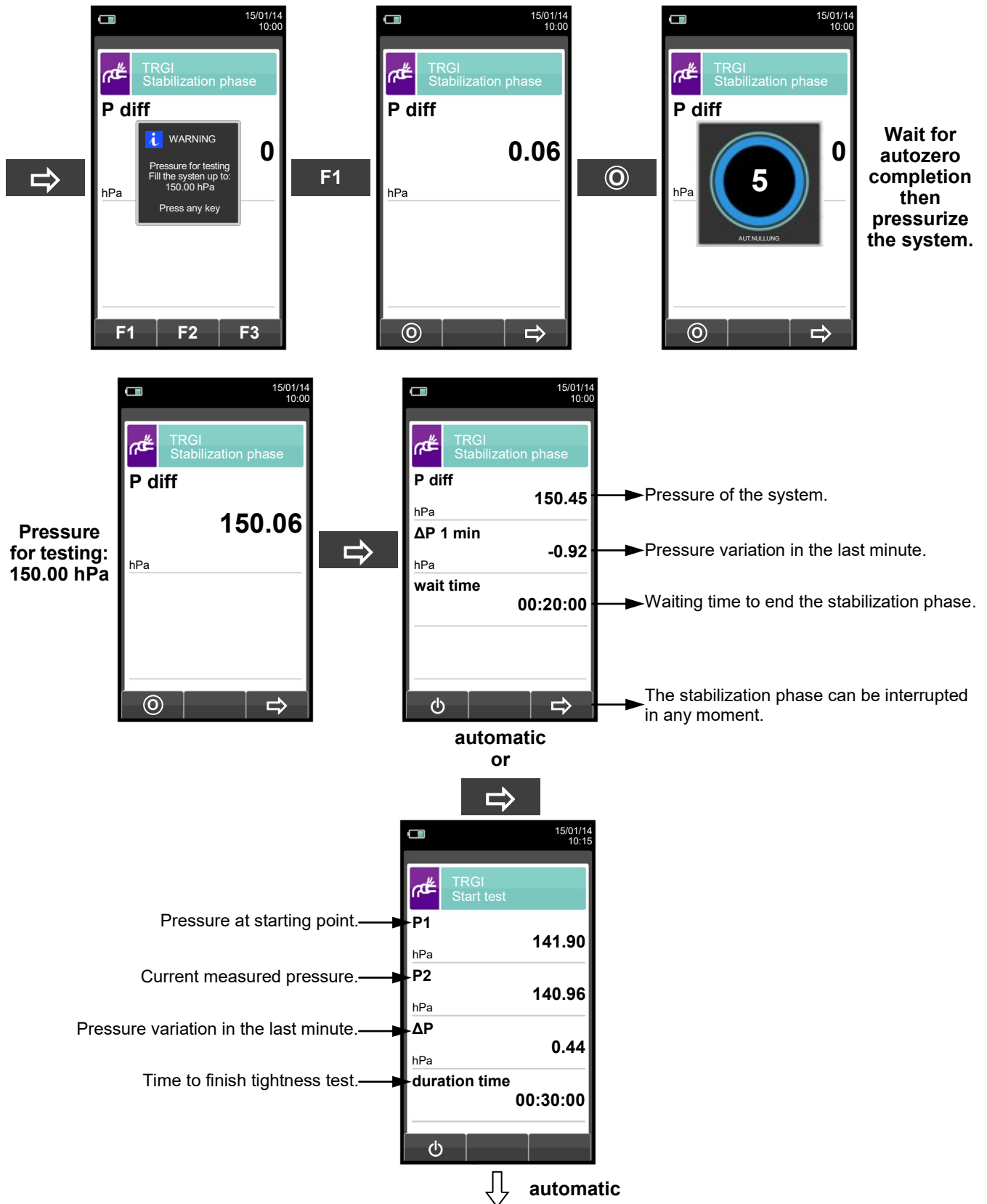

NOTE: If, while configuring the tightness test the automatic printing mode has been selected, the tightness test is printed automatically.

Instead, if the manual printing mode has been selected (exemplified case), at the end of the tightness test the results are displayed and they can be saved and/or printed. In this case proceed as follows.

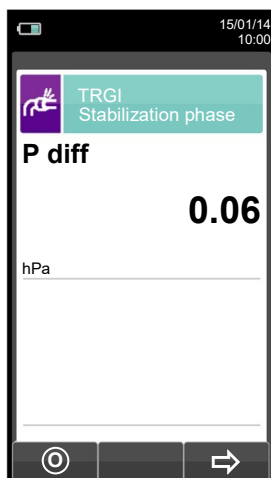
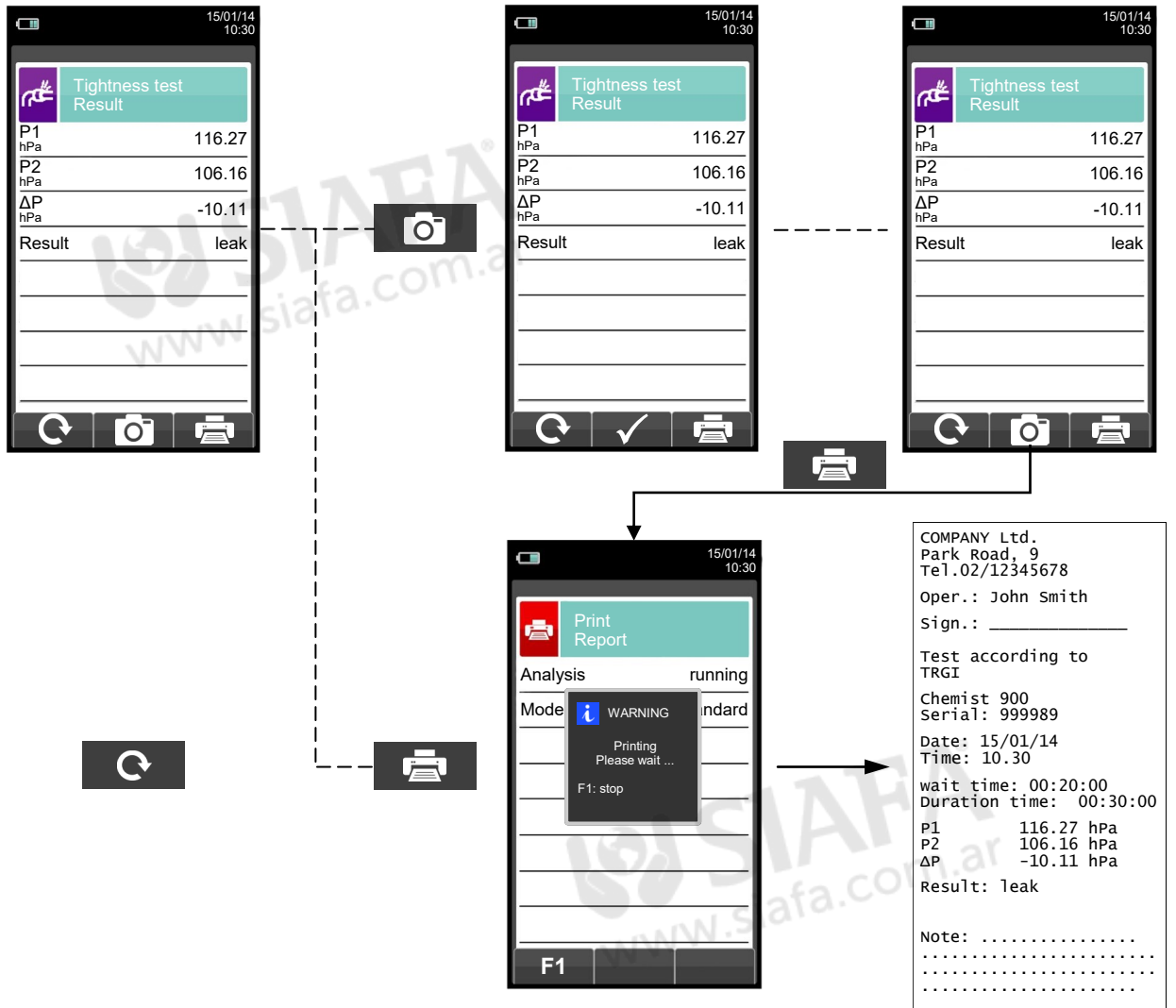

12.10.3 Performing a tightness test for a gas line with volume greater 200 litre.

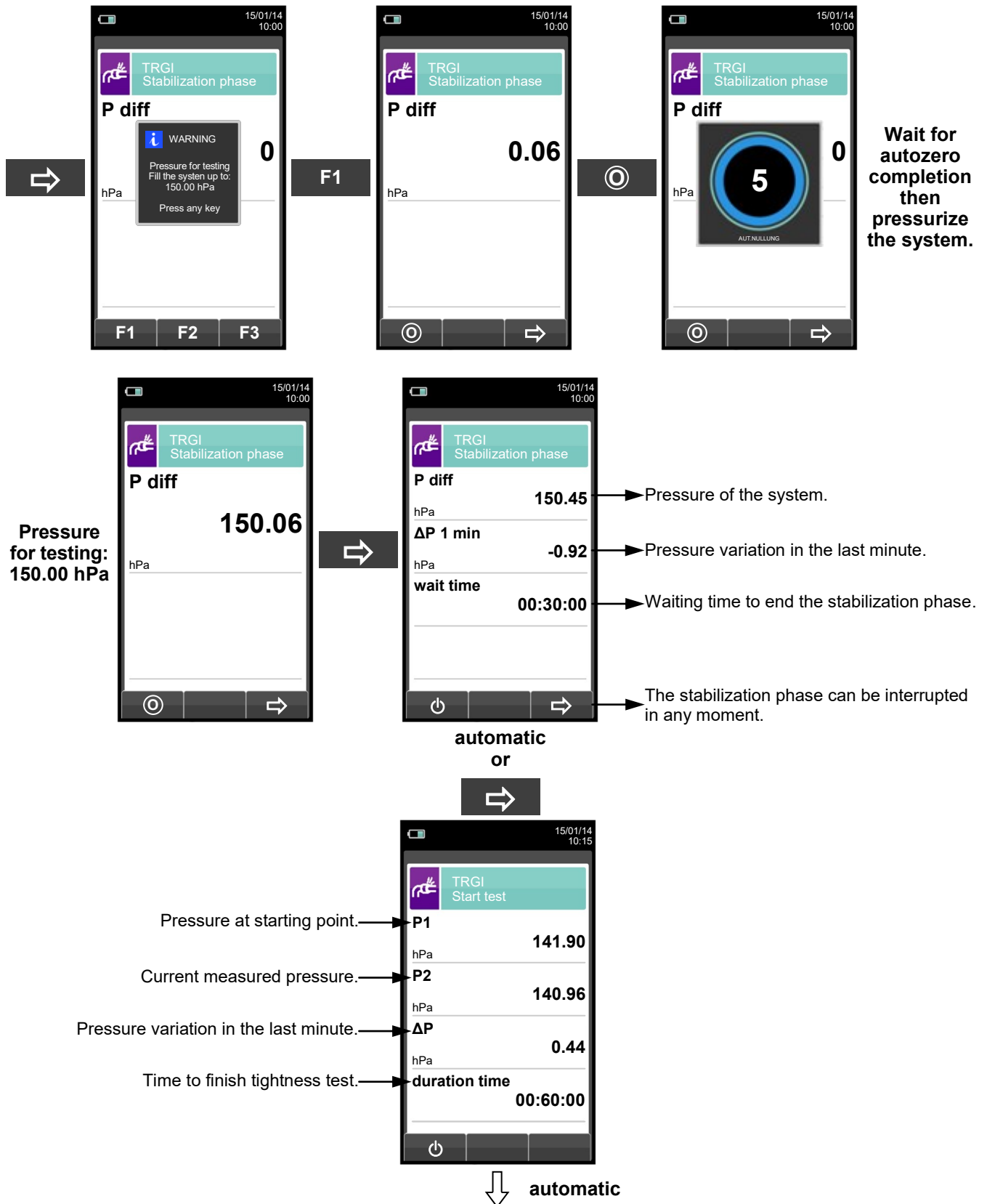

NOTE: If, while configuring the tightness test the automatic printing mode has been selected, the tightness test is printed automatically.

Instead, if the manual printing mode has been selected (exemplified case), at the end of the tightness test the results are displayed and they can be saved and/or printed. In this case proceed as follows.

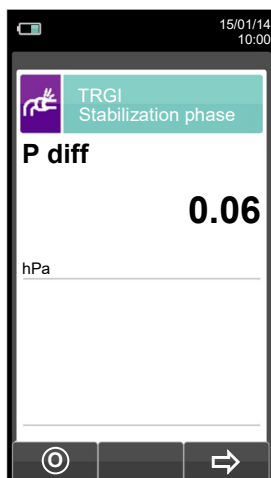
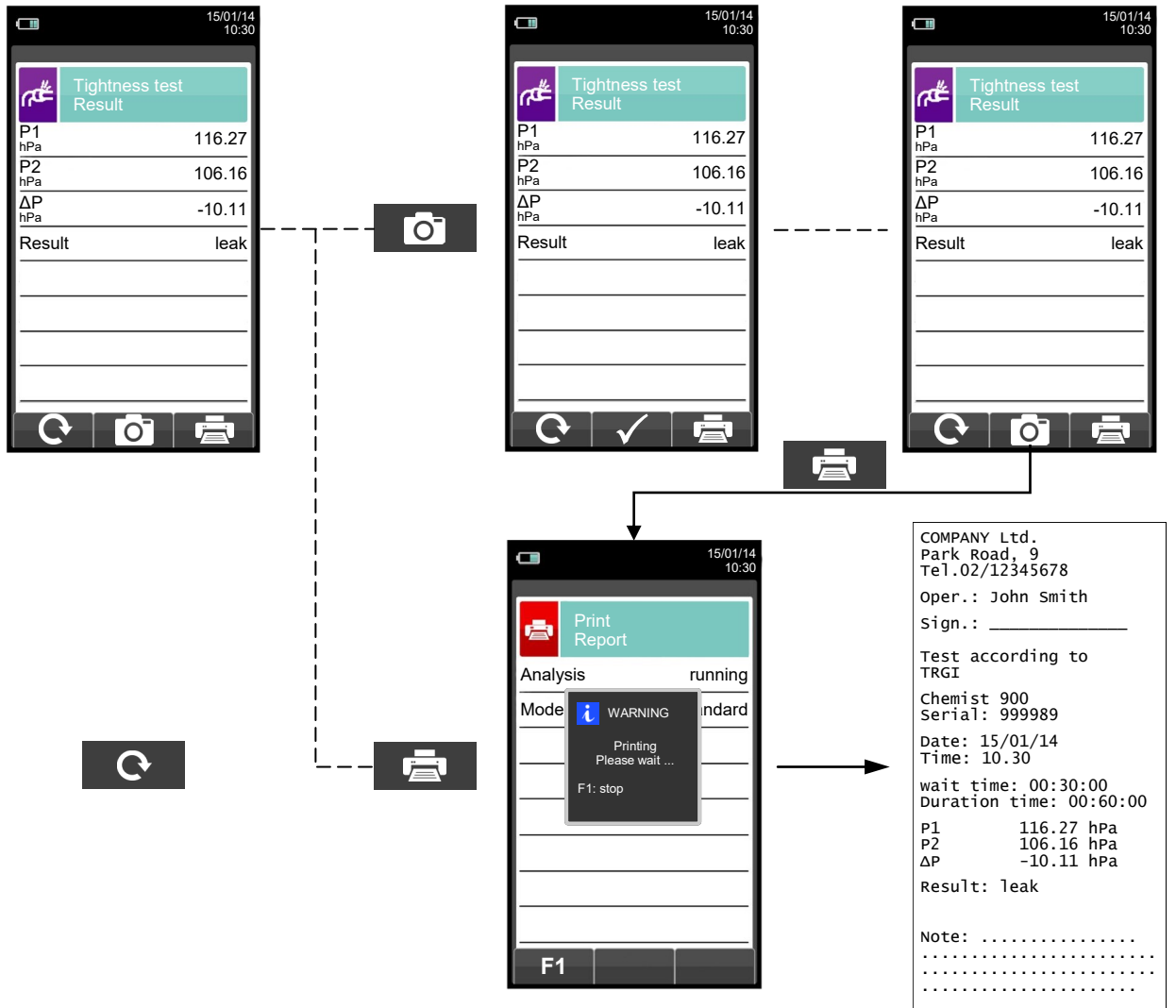

12.11 Measurements → Tightness test → Header

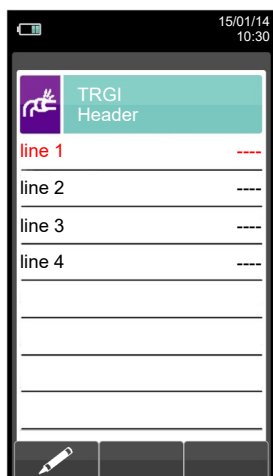

KEY	FUNCTION
	Activate the context keys shown on the display.
	In "edit text": Moves the cursor on the box corresponding to the letter or number required to form the word.
	Selects line; the selected line is displayed in red.
	Activates the context key located in the left side of the display.
	Returns to the previous screen. When in modify mode cancels the modification just made.

CONTEXT KEY	FUNCTION
	Enters edit mode of the selected line: it is possible to enter the name of the operator (24 characters available).
	Confirms the selected letter or digit.
	Cancel the letter or digit before the cursor.
	Cycles through uppercase, lowercase, symbols and special characters.



Example:

1. Edit text

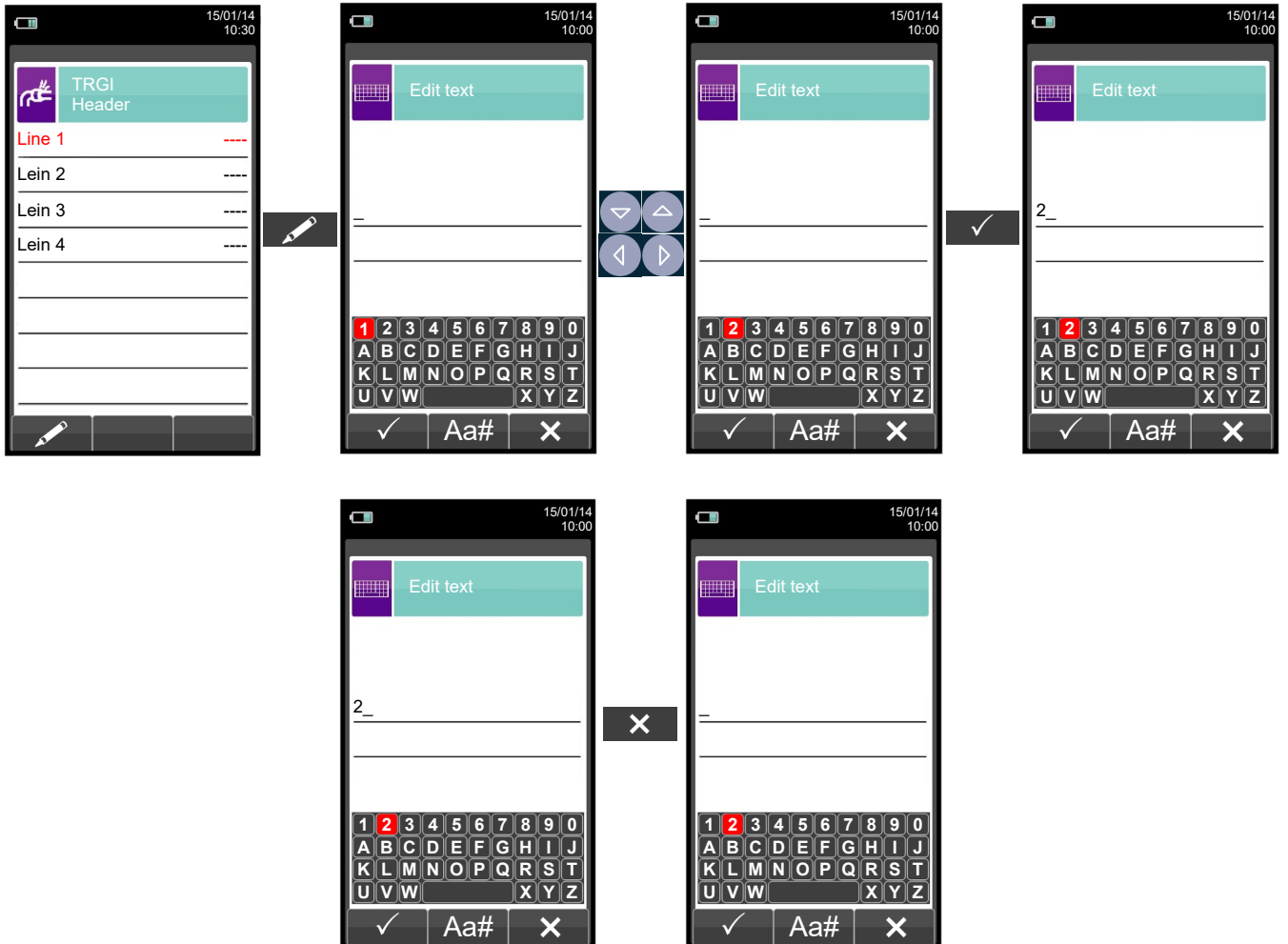



12.12 RESULTS OF THE TIGHTNESS TEST (example)

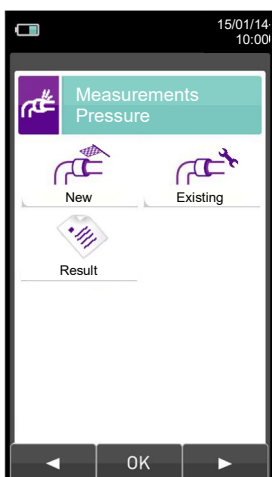
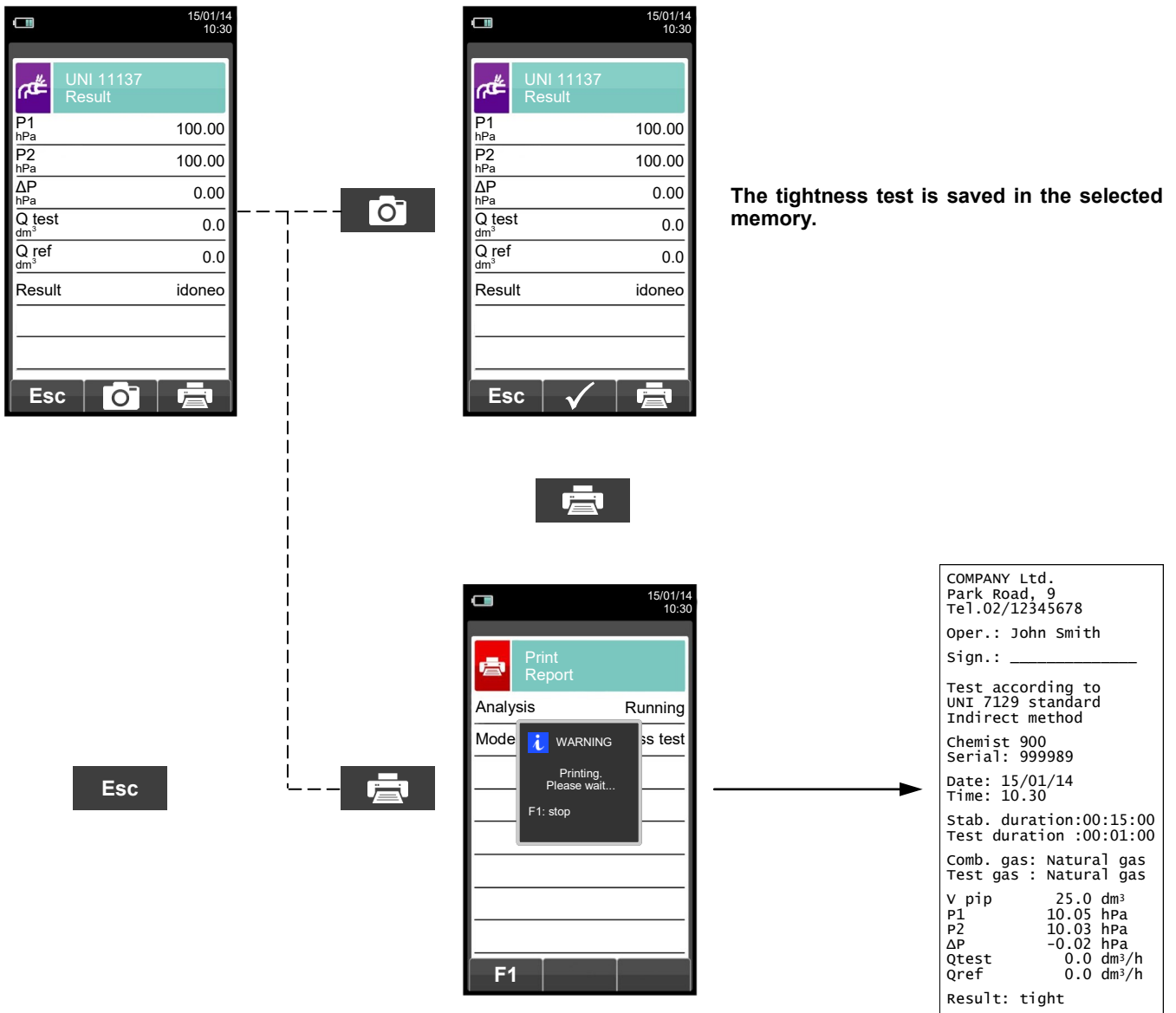

12.13 Measurements → AUX measurements

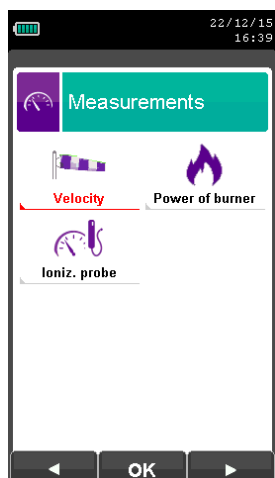

KEY	FUNCTION
	Activate the context keys shown on the display.
	Returns to the previous screen.

CONTEXT KEY	FUNCTION
	Selects the available parameters.
	Enters in the selected parameter setting.
	Selects the available parameters.

PARAMETER	DESCRIPTION
 Velocity	When a Pitot tube and a Tc-K thermocouple are connected, the instrument is capable to measure at the same time both temperature and velocity of a gas (air/flue gas). SEE SECTION 12.14.
 Power of burner	<p>Thermal power of the burner The measurement of the thermal power at the burner can be performed in different ways, depending on the type of fuel selected.</p> <p>Boilers using gaseous fuels FLOW: if the system is equipped with a volumetric flow meter just enter the value of the fuel volume flow (m^3 / h). COUNTER: this mode can be used if the system is equipped with a volumetric flow meter. The volume flow is calculated by reading on the counter, while the generator is in steady operation, the volume of gas flown in a time interval of at least 120 s. MANUAL: if the procedure was provided by the manufacturer and appropriate instructions have been specified on the user manual, the operator can find out the thermal power of the burner and enter it manually. In the absence of counter or any other system for measuring the flow, the nominal thermal power of the boiler stated by the manufacturer is to be assumed as the proper value.</p> <p>Boilers using liquid fuels FLOW: the value of the mass flow rate (kg / h) of the fuel must be entered. MANUAL: if the procedure was provided by the manufacturer and appropriate instructions have been specified on the user manual, the operator can find out the thermal power of the burner and enter it manually. In the absence of counter or any other system for measuring the flow, the nominal thermal power of the boiler stated by the manufacturer is to be assumed as the proper value.</p> <p>SEE SECTION 12.15.</p>
 Ioniz. probe	You can measure the ionization current of a boiler and test its value based on the technical features of the boiler by connecting the ionization probe (optional) to the serial port (See section 7.4 and/or section 7.4.8). SEE SECTION 12.16.



12.14 Measurements → Velocity

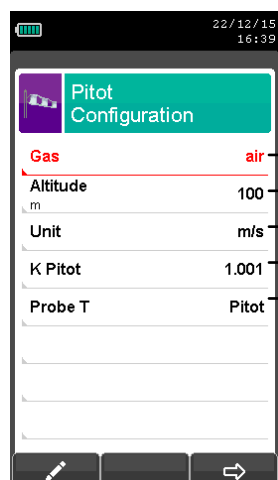

- Measurement: air or flue gas.
- Altitude above sea level.
- Measurement unit selectable across m/s, km/h, fpm, mph.
- Insert the K-factor of the Pitot tube stated by the tube manufacturer.
- Temperature acquisition mode:
Pitot (with Tc-K thermocouple) or Flue gas probe (or external Tc-K thermocouple).

KEY	FUNCTION
	Activate the context keys shown on the display.
	Selects line; the selected line is displayed in red. In edit mode, it sets the desired value.
	Activates the context key located in the left side of the display.
	Returns to the previous screen. When in modify mode cancels the modification just made.

CONTEXT KEY	FUNCTION
	Enters the modification mode for the selected parameter.
	Confirms the value entered.
	Go to next step.
	Make the zero for the measurement.
	Saves, in the memory selected in the "Select Memory" menu, the data acquired.
	Starts printing the paper print-out. See section 11.

12.14.1 Connecting the Pitot tube to the instrument



- Connect the Pitot tube (accessory) to inputs P+ and P- (which are normally used for the differential pressure measurement)
- Connect the Tc-K thermocouple cable from the flue gas probe to connector T1 of the instrument.

WARNING: When a Pitot tube integrated to a Tc-K thermocouple is used, remember to connect the thermocouple connector to T1 input at instrument side. In this case the flue gas probe must not be connected.

NOTE: the hoses associated to static and dynamic pressure can be connected either to the inputs P+ or P-

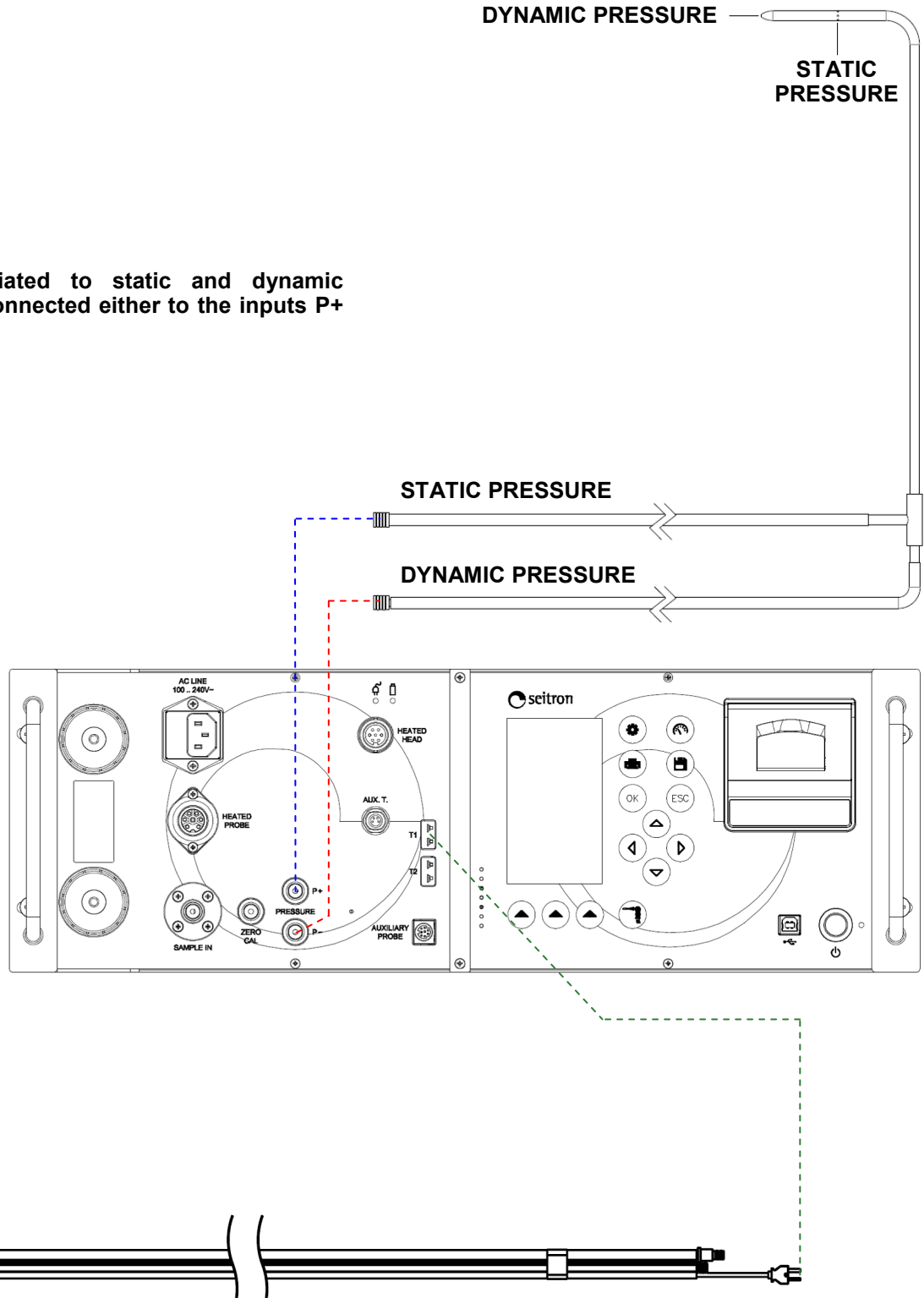

12.14.2 PERFORMING THE TEST

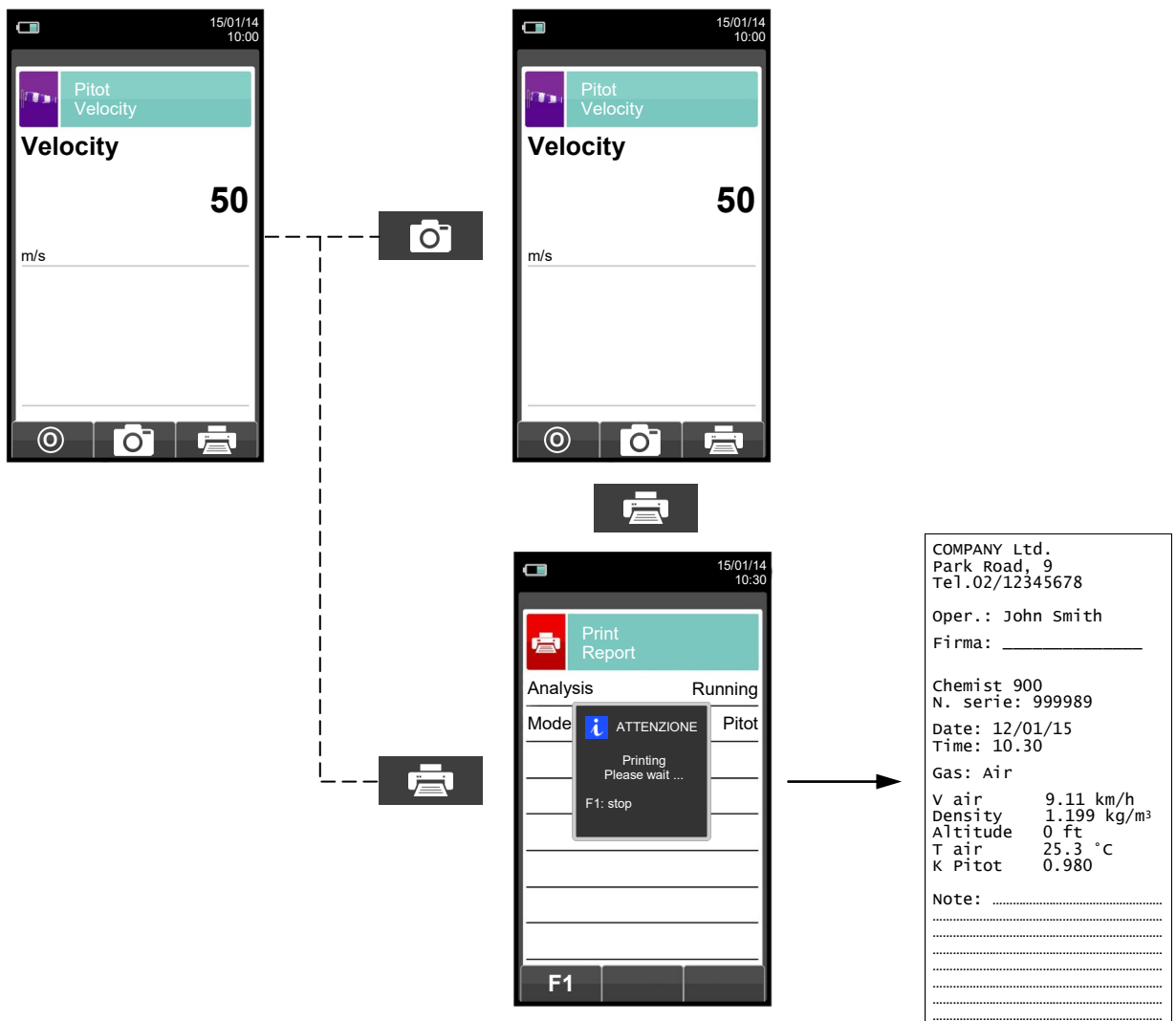

12.15 Measurements → Power of burner

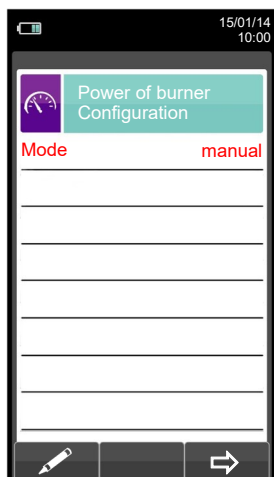

Enter the thermal power value calculated manually by the operator.

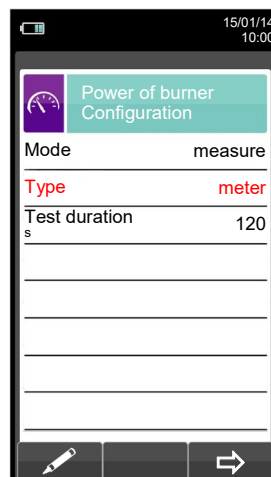

Test mode: you can choose to calculate the thermal power by entering a flow value, or by reading the volumetric counter (gaseous fuels only).

Duration of test: the option is displayed only for the test mode 'COUNTER', available for gaseous fuels. It is possible to enter the number of seconds between the reading of the initial and final gas volume. The minimum time required by law is 120 s.

KEY	FUNCTION
	Activate the context keys shown on the display.
	Selects line; the selected line is displayed in red. When in modify mode, sets the desired value.
	In change moves the cursor to the box corresponding to the desired number to set the desired value.
	Activates the context key located in the left side of the display.
	Returns to the previous screen. When in modify mode cancels the modification just made.

CONTEXT KEY	FUNCTION
	Enters the modification mode for the selected parameter.
	Confirms the settings.
	Go to next step.
	Saves, in the memory selected in the "Memory Select" menu, the value of the draft measured.
	Stops the test.

12.15.1 TESTING IN 'MANUAL' MODE

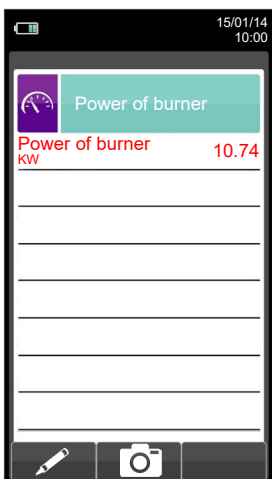
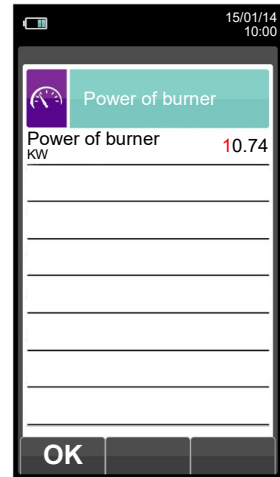
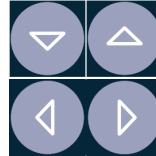
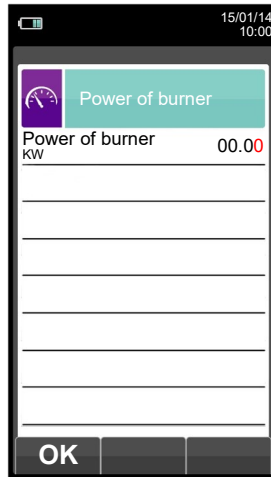
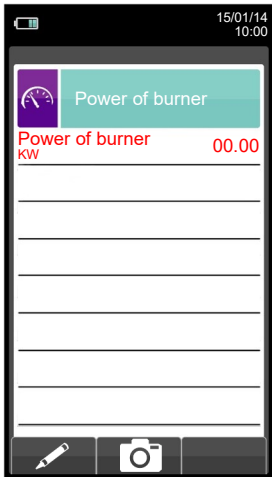

12.15.2 TESTING IN 'MEASURE' MODE (based on Flow rate)

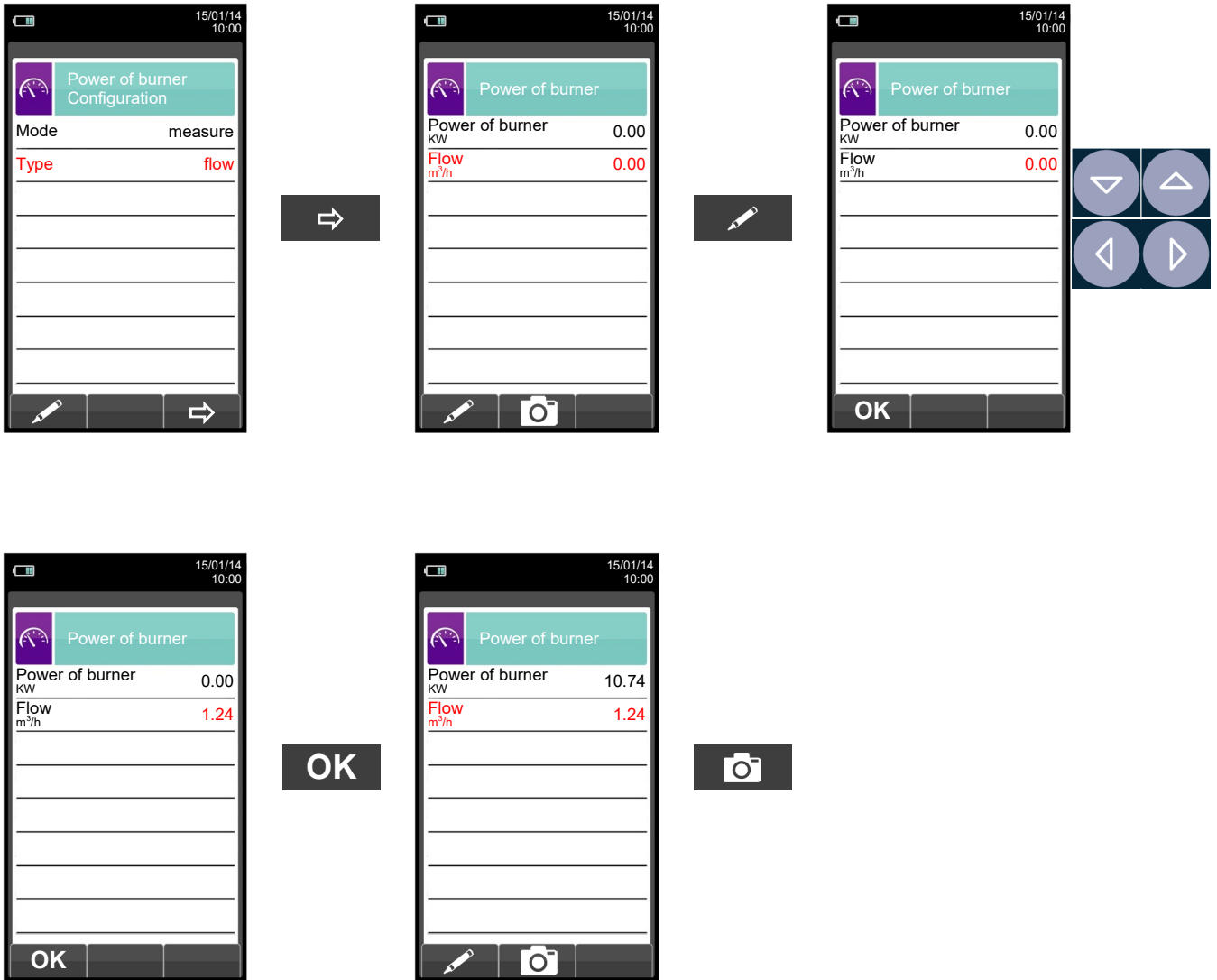

12.15.3 TESTING IN 'MEASURE' MODE (based on meter)

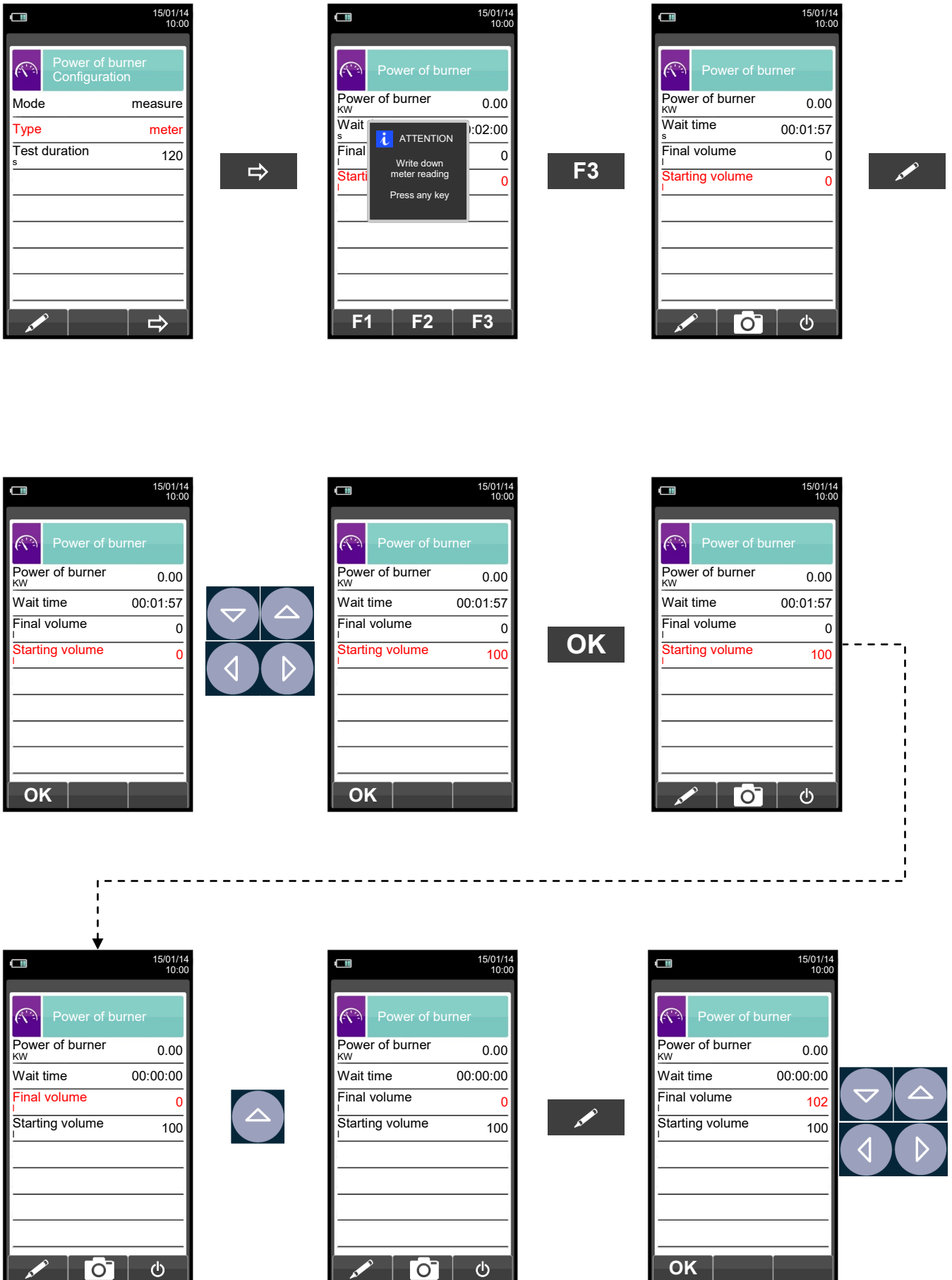

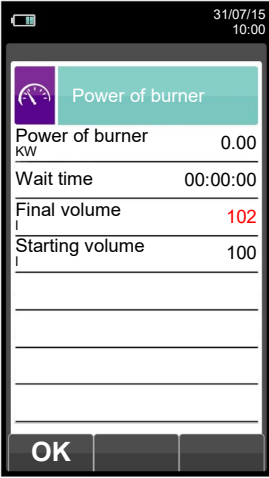



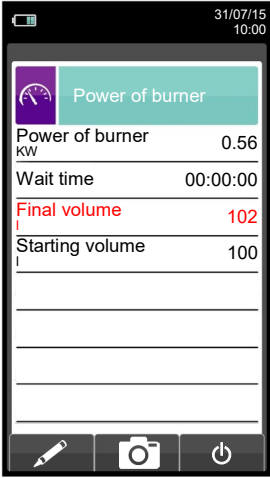

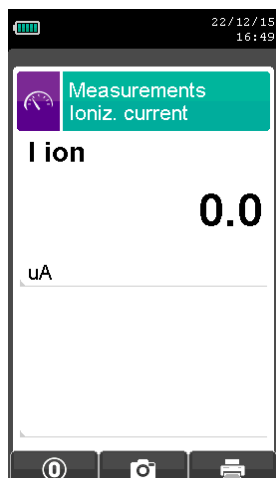

OK



12.16 Measurements → Ionization probe



KEY	FUNCTION
	Activate the context keys shown on the display.
	Returns to the previous screen.

CONTEXT KEY	FUNCTION
	Zeroes the current value.
	Acquires the current value for a further saving in the memory selected in the "Select Memory" menu.
	Starts printing the report. See section 11.

13.1 FLUE GAS ANALYSIS



To perform a full flue gas analysis, follow the instructions below.



SOME IMPORTANT WARNINGS TO CONSIDER DURING THE COMBUSTION ANALYSIS ARE LISTED BELOW:

FOR A CORRECT ANALYSIS NO AIR MUST FLOW INTO THE PIPE FROM OUTSIDE DUE TO A BAD TIGHTENING OF THE CONE OR A LEAK IN THE PIPELINE.

THE GAS PIPE MUST BE CHECKED IN ORDER TO AVOID ANY LEAKAGES OR OBSTRUCTIONS ALONG THE PATH.

THE CONNECTORS OF THE GAS SAMPLING PROBE AND OF THE CONDENSATE FILTER MUST BE WELL CONNECTED TO THE INSTRUMENT.

KEEP THE CONDENSATE TRAP IN THE VERTICAL POSITION DURING THE ANALYSIS; A WRONG POSITIONING MAY CAUSE CONDENSATE INFILTRATIONS IN THE INSTRUMENT AND THUS DAMAGE THE SENSORS.

DO NOT PERFORM ANY MEASUREMENT WHEN THE FILTER IS REMOVED OR DIRTY IN ORDER TO AVOID ANY RISK OF IRREVERSIBLE DAMAGES ON SENSORS.

13.1.1 Switching on the instrument and auto-calibration

Press the On/Off key to switch on the instrument - an introductory screen will appear. After a couple of moments the instrument will zero itself and will state that the sample probe should not be inserted in the stack.

In case the instrument is equipped with the electrovalve for automatic auto-zeroing, it will ask for the insertion of the gas probe in the stack. On the other hand if the instrument has not the electrovalve, it will require not to insert the gas probe in the stack.

In the latter it is important that the sample probe is not inside the stack since, during auto-calibration, the instrument draws fresh air from the environment and detects the zero value of the O₂, CO and NO sensors, the details of which are then memorized and used for reference during the analysis. It is equally important that this phase is performed in a fresh-air environment.

The pressure sensor (piezoresistive, temperature compensated) is also zeroed during auto-calibration.

13.1.2 Inserting the probe inside the stack

When auto-calibration is complete the instrument will instruct the user to insert the sample probe that has been previously connected to the relative input on the instrument, and the analysis screen will appear automatically.

In order for the probe to be inserted at the right point within the stack, its distance from the boiler has to be twice the diameter of the stack pipe itself or, if this is not possible, must comply with the boiler manufacturer's instructions.

In order to position the probe correctly, a reliable support must be provided by drilling a 13/16 mm hole in the manifold (unless already present) and screwing in the positioning cone provided with the probe - in this way no air is drawn from the outside during sampling.

The screw on the cone allows the probe to be stopped at the right measuring depth - this usually corresponds to the center of the exhaust pipe. For greater positioning accuracy, the user may insert the probe gradually into the pipe until the highest temperature is read. The exhaust pipe must be inspected before carrying out the test, so as to ensure that no constrictions or losses are present in the piping or stack.



13.1.3 Simultaneous measurement of pressure, O₂, pollutants

In order to measure simultaneously pressure, O₂ and pollutants levels as well as all the others calculated parameters necessary to obtain the correct performance value, connect the instrument as follows:

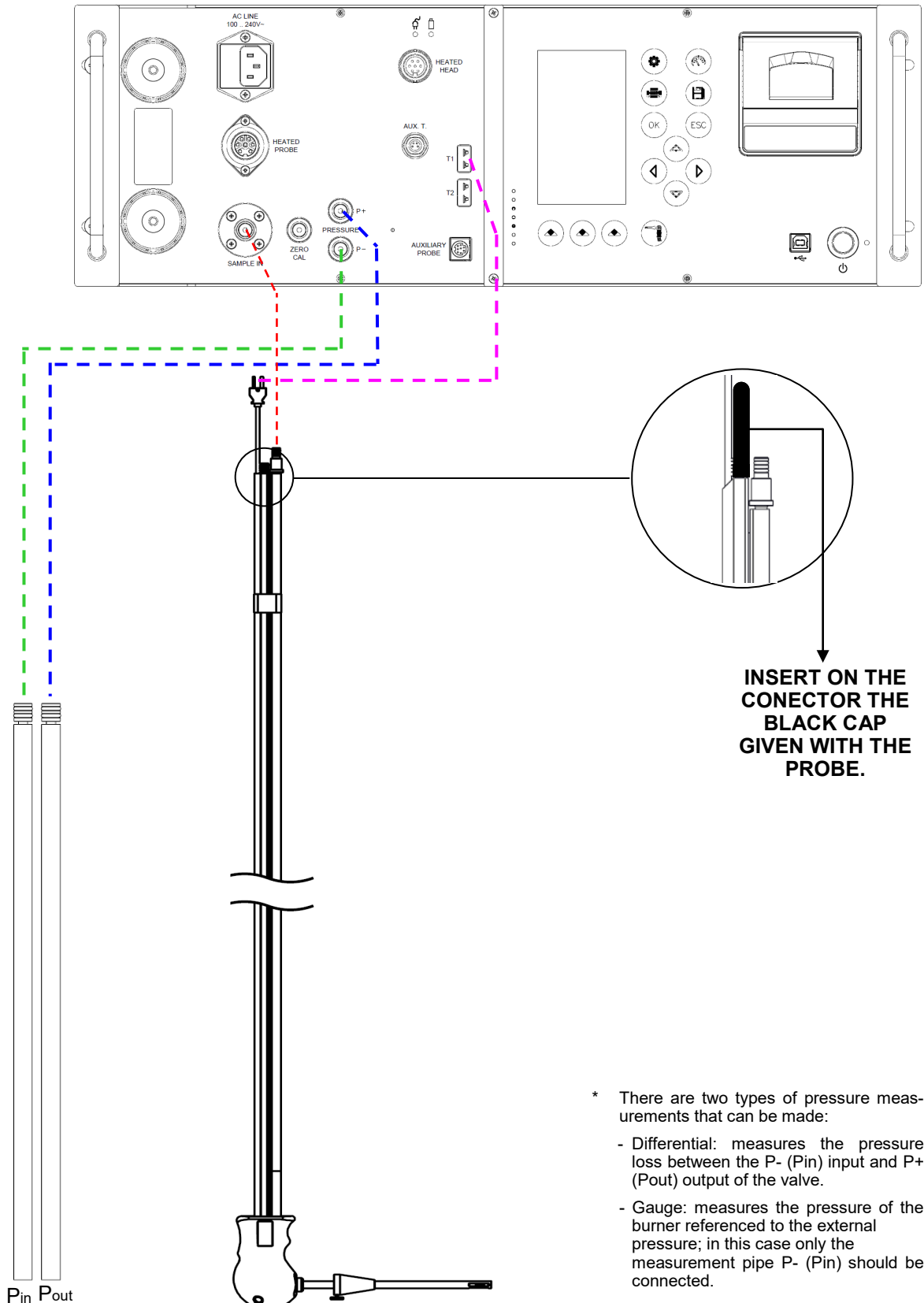

- * There are two types of pressure measurements that can be made:
- Differential: measures the pressure loss between the P- (Pin) input and P+ (Pout) output of the valve.
 - Gauge: measures the pressure of the burner referenced to the external pressure; in this case only the measurement pipe P- (Pin) should be connected.



13.1.4 Flue Gas Analysis

After the sample probe has been inserted in the stack and the combustion air temperature probe (if used) has been inserted in the relative sample manifold, if the instrument has not been configured during auto-calibration, the following data must be configured:

Memory: use this submenu to define the memory in which the test data and client details are to be stored.

Fuel: select the type of fuel burned in the combustion equipment producing the flue/exhaust gas being measured.

Operator: this is where the name of the test operator can be entered.

Mode: by entering this submenu, the user can determine the analysis mode - manual or automatic.

If automatic mode is chosen, the reading duration of each and every test must be set, besides the printing mode - manual or automatic. When flue gas analysis begins, the instrument will perform and memorize the three tests automatically, at the respective intervals set (at least 120 sec. according to UNI 10389-1).

At the end of each test the instrument will emit an audible alarm (one "beep" after the first test, two "beeps" after the second test and three "beeps" after the third test).

At this point, when all three tests are over, if "Manual Printing" has been chosen the instrument will display the average of the three tests with the possibility of recalling the individual values.

If desired, the user can then print the relative data (total, complete, etc....). On the contrary, if "Automatic Printing" was selected, the instrument will print the test data automatically, based on the current print settings, without displaying the average test values.

Caution: when in automatic mode Draft, Smoke and ambient CO (NO) measurements must be taken before initiating the flue gas analysis.

If, on the other hand, manual analysis mode is chosen, flue gas analysis will proceed manually (please see relative Flow Chart). In this case the print settings and automatic test duration will not be considered.

At this point manual analysis may commence, first waiting at least two minutes until the displayed values stabilize: The user can then proceed with data storage, if required, or print the analysis report directly, which will be printed in the format set beforehand.

When all three tests are over, the user can recall the average analysis screen containing all the data necessary for compiling the maintenance log of the boiler or plant.

In both modes, automatic and manual, the displayed data of the pollutants CO / NO / NO_x can be translated into normalized values (with reference to the concentration of O₂ previously set).

13.1.5 End of Analysis

At the end of the combustion analysis, carefully remove the sample probe and remote air temperature probe, if used, from their relative ducts, taking care not to get burnt.

It is recommended to purge the analyzer with clean fresh air for at least 5 to 10 minutes before turning off the instrument by pressing the On/Off key.

At this point, if the instrument has detected a high concentration of CO and/or NO, a self-cleaning cycle will be initiated during which the pump will draw fresh outside air until the gas levels drop below acceptable values.

At the end of the cycle (lasting no longer than 3 min.) the instrument will switch itself off automatically.

13.2 FLUE GAS ANALYSIS - PRELIMINARY OPERATIONS

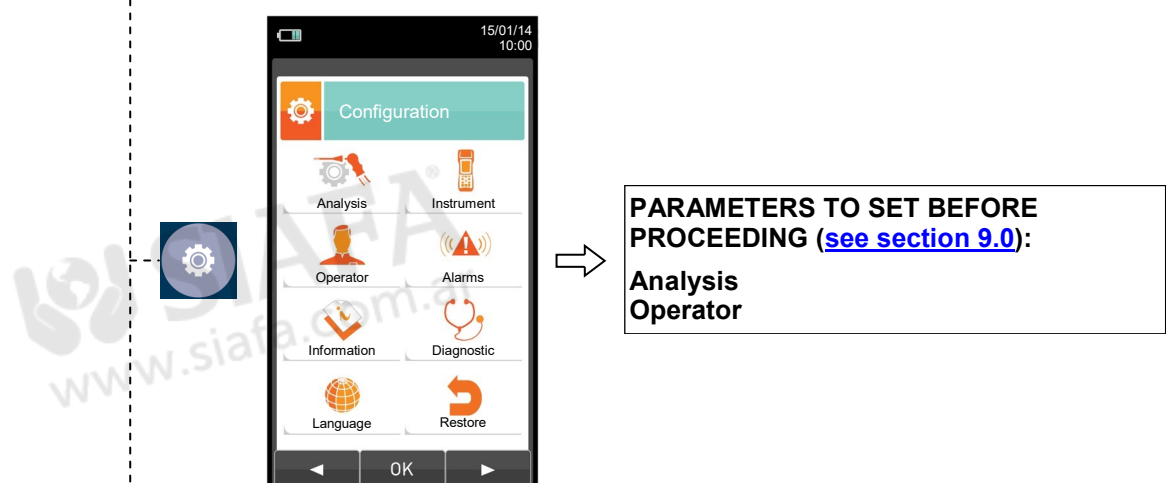
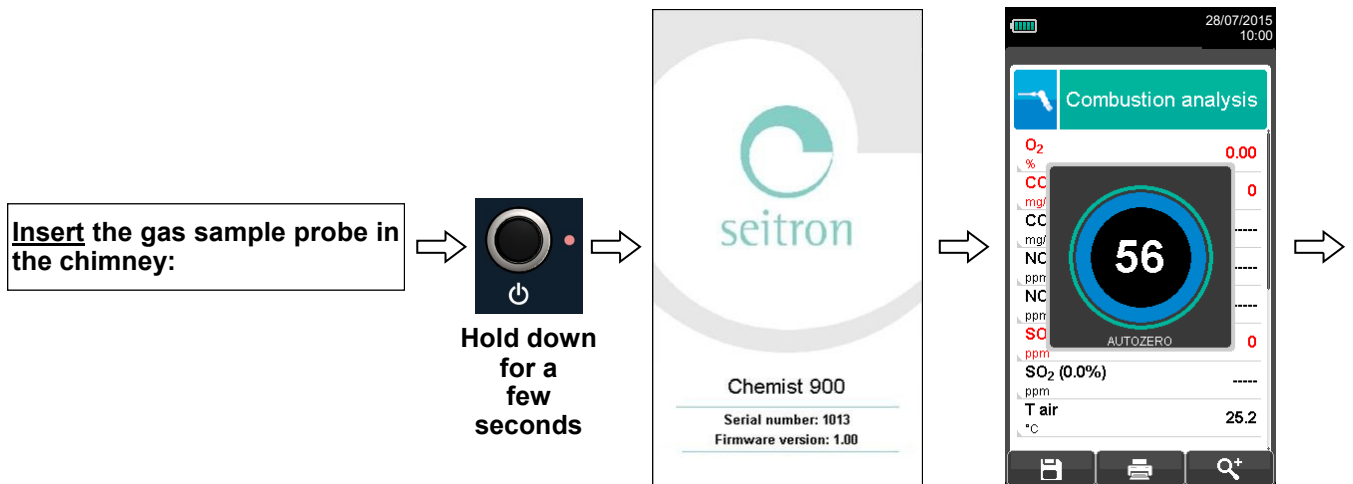

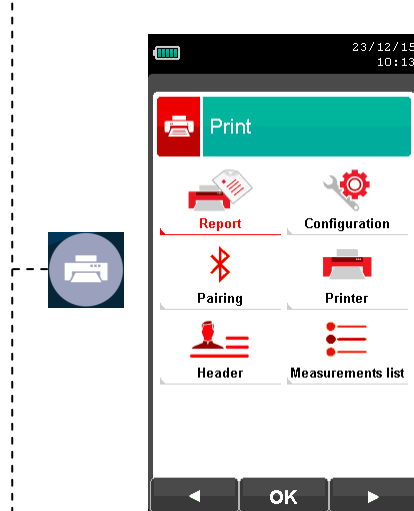

PARAMETERS TO SET BEFORE PROCEEDING (see section 11.0):

Configuration
Header
Measures list

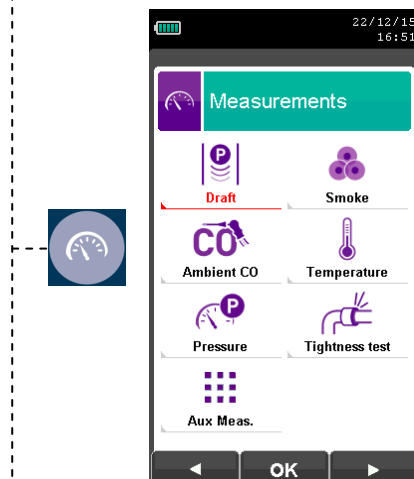

ACQUIRE THE FOLLOWING MEASUREMENTS BEFORE PROCEEDING WITH THE COMBUSTION ANALYSIS (see section 12.0):



In you don't, the measurements will not be printed with the combustion analysis.

Draft
Smoke
Ambient CO
Temperature
Pressure

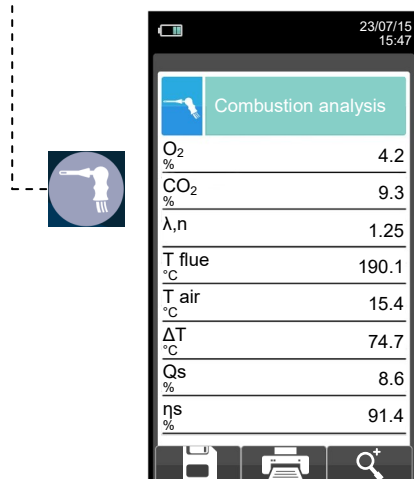

PRESS THE KEY '  ':
This starts saving the current analysis according to the set mode.

- Manual [See section 10.5.1](#)
- UNI 10389 [See section 10.5.2](#)
- BlmSchV [See section 10.5.2](#)
- Data logger [See section 10.5.2](#)
- Periodic [See section 10.5.3](#)

PRESS THE KEY '  ':
This starts the printing on test paper print-out of the current analysis; additional measurements are also printed, if they are present in the memory.

13.3 PERFORMING COMBUSTION ANALYSIS - MANUAL MODE



15/01/14 10:00

Combustion analysis

O ₂ %	4.2
CO ₂ %	9.3
λ,n	1.25
T flue °C	190.1
T air °C	15.4
ΔT °C	74.7
Qs %	8.6
ηs %	91.4



15/01/14 10:00

Memory Save

Mode	manual
Memory	12
Analysis	1

OK
Saves analysis number 1

15/01/14 10:00

Combustion analysis

O ₂ %	4.2
CO ₂ %	9.3
λ,n	1.25
T flue °C	190.1
T air °C	15.4
ΔT °C	74.7
Qs %	8.6
ηs %	91.4



15/01/14 10:00

Memory Save

Mode	manual
Memory	12
Analysis	2

OK
Saves analysis number 2

15/01/14 10:00

Combustion analysis

O ₂ %	4.2
CO ₂ %	9.3
λ,n	1.25
T flue °C	190.1
T air °C	15.4
ΔT °C	74.7
Qs %	8.6
ηs %	91.4



15/01/14 10:00

Memory Save

Mode	manual
Memory	12
Analysis	3

OK
Saves analysis number 3

15/01/14 10:00

Combustion analysis

O ₂ %	4.2
CO ₂ %	9.3
λ,n	1.25
T flue °C	190.1
T air °C	15.4
ΔT °C	74.7
Qs %	8.6
ηs %	91.4



23/12/15 10:29

Memory

Save	Average
Select	Data logger
Delete	Usage %

Recalls the average analysis.



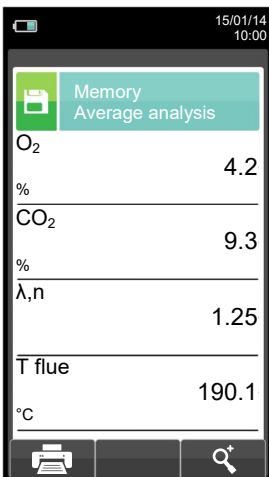
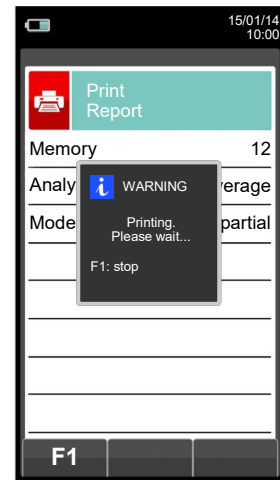
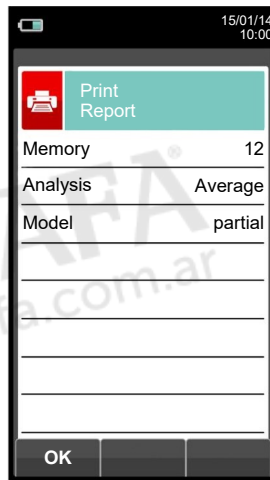
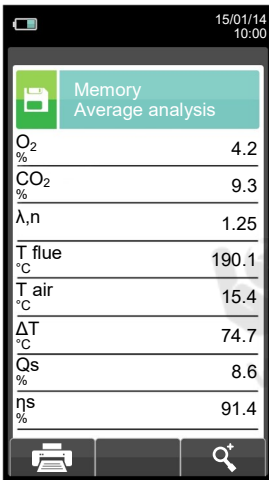

```

Date: 15/01/14
Time: 10.10
Fuel: Natural gas
Altitude: 0 m
R.H. air: 50 %
O2 4.2 %
CO2 9.3 %
λ,n 1.25
T flue 190.2 °C
T air 15.4 °C
dT 174.8 °C
QS 8.6 %
Es 91.4 %
EC 4.9 %
Et 96.3 %
CO 148 ppm
NO 40 ppm
NOX/NO: 1.03
NOX 41 ppm
Amb. CO 0 ppm
Draft: 0.05 hPa
T out: 20 °C
Smoke: 3 1 2
Aver. n: 2
    
```

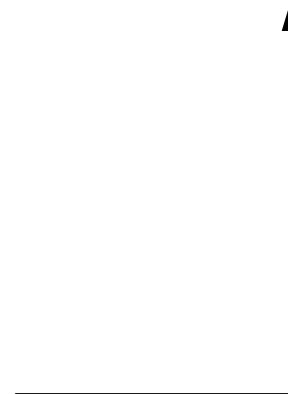
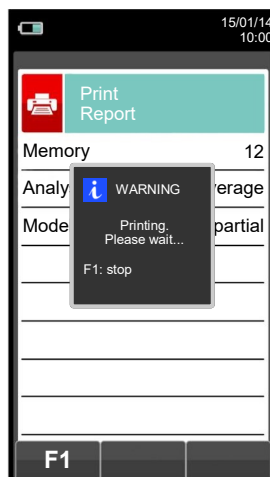
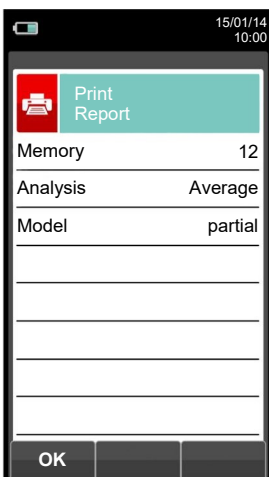



NOTE: If, while configuring the tightness test the automatic printing mode has been selected, the tightness test is printed automatically.

Instead, if the manual printing mode has been selected (exemplified case), at the end of the tightness test the results are displayed and they can be saved and/or printed. In this case proceed as follows:

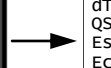
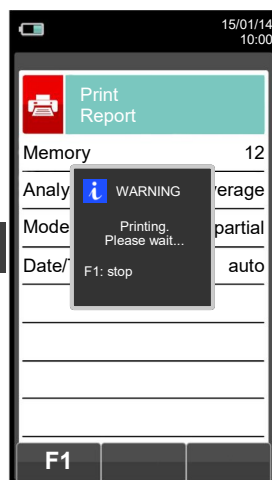
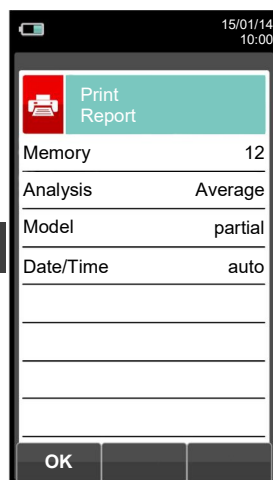
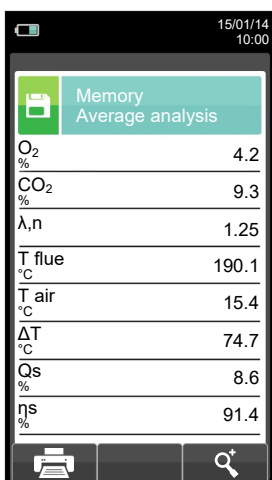

```

Date: 15/01/14
Time: 10.10
Fuel: Natural gas
Altitude: 0 m
R.H. air: 50 %
O2          4.2 %
CO2         9.3 %
λ,n         1.25
T flue     190.2 °C
T air      15.4 °C
dT         174.8 °C
QS         8.6 %
ES         91.4 %
Ec         4.9 %
Et         91.4 %
CO         148 ppm
NO         40 ppm
NOX/NO:    1.03
NOX        41 ppm
Amb. CO    0 ppm
Draft:     0.05 hPa
T out:     20 °C
Smoke: 3 1 2
Aver. n:   2
    
```



13.5 PERFORMING THE COMBUSTION ANALYSIS - BlmSchV MODE

The first screenshot shows the 'Combustion analysis' screen with the following data:

O ₂ %	4.2
CO ₂ %	9.3
λ,n	1.25
T flue °C	190.1
T air °C	15.4
ΔT °C	74.7
Qs %	8.6
ηs %	91.4

The second screenshot shows the 'Memory Save' configuration screen:

Mode	BlmSchV
Memory	3
Samples	30
Interval s	1

The third screenshot shows the 'Combustion analysis BlmSchV' screen with the same data as the first screenshot.

Annotations: A save icon points to the second screen, and an 'OK' button is shown between the second and third screens. An arrow points to the text: "Automatically saves the first sample when the set time is over."

The screenshot shows the 'Combustion analysis BlmSchV' screen with the same data as the previous screenshots. The bottom bar shows a power icon, a '2' over a '1' icon, and a search icon.

Automatically saves the second sample when the preset time interval has elapsed and so on until the last sample.

Once the flue gas analysis is completed the instrument saves the average value of the samples taken.

NOTE: If, while configuring the tightness test the automatic printing mode has been selected, the tightness test is printed automatically.

Instead, if the manual printing mode has been selected (exemplified case), at the end of the tightness test the results are displayed and they can be saved and/or printed. In this case proceed as follows:

The first screenshot shows the 'Memory Analisi BlmSchV' screen with the same data as the previous screenshots.

The second screenshot shows the 'Print Report' screen with the following configuration:

Memory	3
Analysis	BlmSchV
Model	partial

The third screenshot shows the 'Print Report' screen with a 'WARNING' dialog box that says: "Printing. Please wait... F1: stop".

The fourth screenshot shows the printed report:

```
Date: 15/01/14
Time: 10.10
Fuel: Natural gas
Altitude: 0 m
R.H. air: 50 %
O2          4.2 %
CO2         9.3 %
λ,n         1.25
T flue     190.2 °C
T air      15.4 °C
dT         174.8 °C
QS         8.6 %
ES         91.4 %
Ec         4.9 %
Et         96.3 %
CO         148 ppm
NO         40 ppm
NOX/NO:    1.03
NOX        41 ppm
CO amb     0 ppm
Draft:     0.05 hPa
T out:     20 °C
Smoke:    3 1 2
Aver. n:   2
```

13.6 PERFORMING THE COMBUSTION ANALYSIS - data logger MODE



15/01/14
10:00

Combustion analysis

O ₂ %	4.2
CO ₂ %	9.3
λ,n	1.25
T flue °C	190.1
T air °C	15.4
ΔT °C	74.7
Qs %	8.6
ηs %	91.4

Save Print Search



15/01/14
10:00

Memory Save

Mode	data logger
Memory	1
Samples	10
Interval s	60

OK



15/01/14
10:00

Combustion analysis data logger

O ₂ %	4.2
CO ₂ %	9.3
λ,n	1.25
T flue °C	190.1
T air °C	15.4
ΔT °C	74.7
Qs %	8.6
ηs %	91.4

Power 1 60 Search



15/01/14
10:02

Combustion analysis data logger

O ₂ %	4.2
CO ₂ %	9.3
λ,n	1.25
T flue °C	190.1
T air °C	15.4
ΔT °C	74.7
Qs %	8.6
ηs %	91.4

WARNING
Data logger active.
Interrupt?
F1: Interrupt
F2: continue
F3: pause

F1 F2 F3



Automatically saves the first sample when the set time is over.

15/01/14
10:02

Combustion analysis data logger

O ₂ %	4.2
CO ₂ %	9.3
λ,n	1.25
T flue °C	190.1
T air °C	15.4
ΔT °C	74.7
Qs %	8.6
ηs %	91.4

Power 2 60 Search

Automatically saves the second sample when the set time is over and so on until the last sample.





NOTE: If, while configuring the tightness test the automatic printing mode has been selected, the tightness test is printed automatically.

Instead, if the manual printing mode has been selected (exemplified case), at the end of the tightness test the results are displayed and they can be saved and/or printed. In this case proceed as follows:

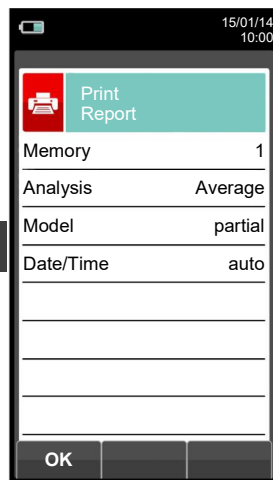
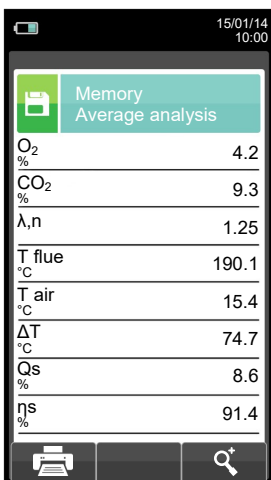

OK

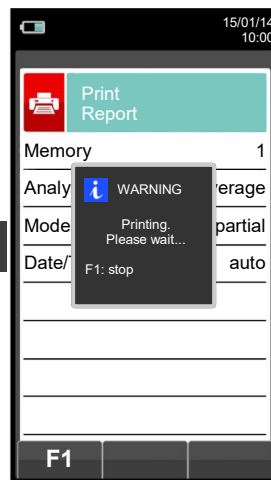

Date:	15/01/14
Time:	10.10
Fuel:	Natural gas
Altitude:	0 m
R.H. air:	50 %
O2	4.2 %
CO2	9.3 %
λ,n	1.25
T flue	190.2 °C
T air	15.4 °C
ΔT	174.8 °C
Qs	8.6 %
Es	91.4 %
Ec	4.9 %
Et	91.4 %
CO	148 ppm
NO	40 ppm
NOX/NO:	1.03
NOX	41 ppm
Amb. CO	0 ppm
Draft:	0.05 hPa
T out:	20 °C
Smoke:	3 1 2
Aver. n:	2

13.7 PERFORMING THE COMBUSTION ANALYSIS - PERIODIC MODE

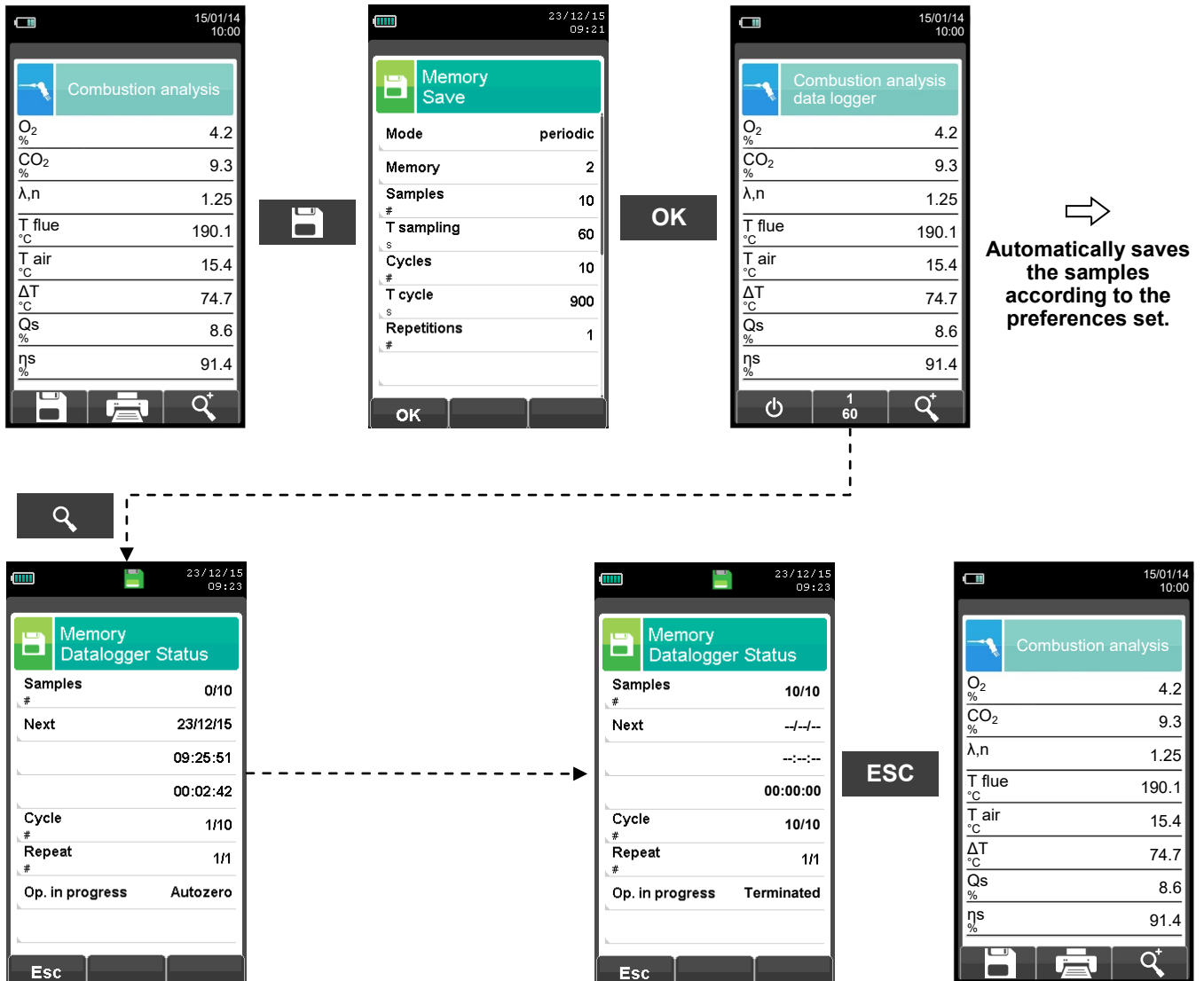

NOTE: Once the emissions analysis is completed (an audible signal will be emitted), the average of the samples acquired will be displayed on the instrument. The stored analyses can be individually displayed and printed directly from the instrument or can be downloaded to the PC for further processing.

14.0 SENSORS

14.1 Positioning of sensors inside the sensor compartment

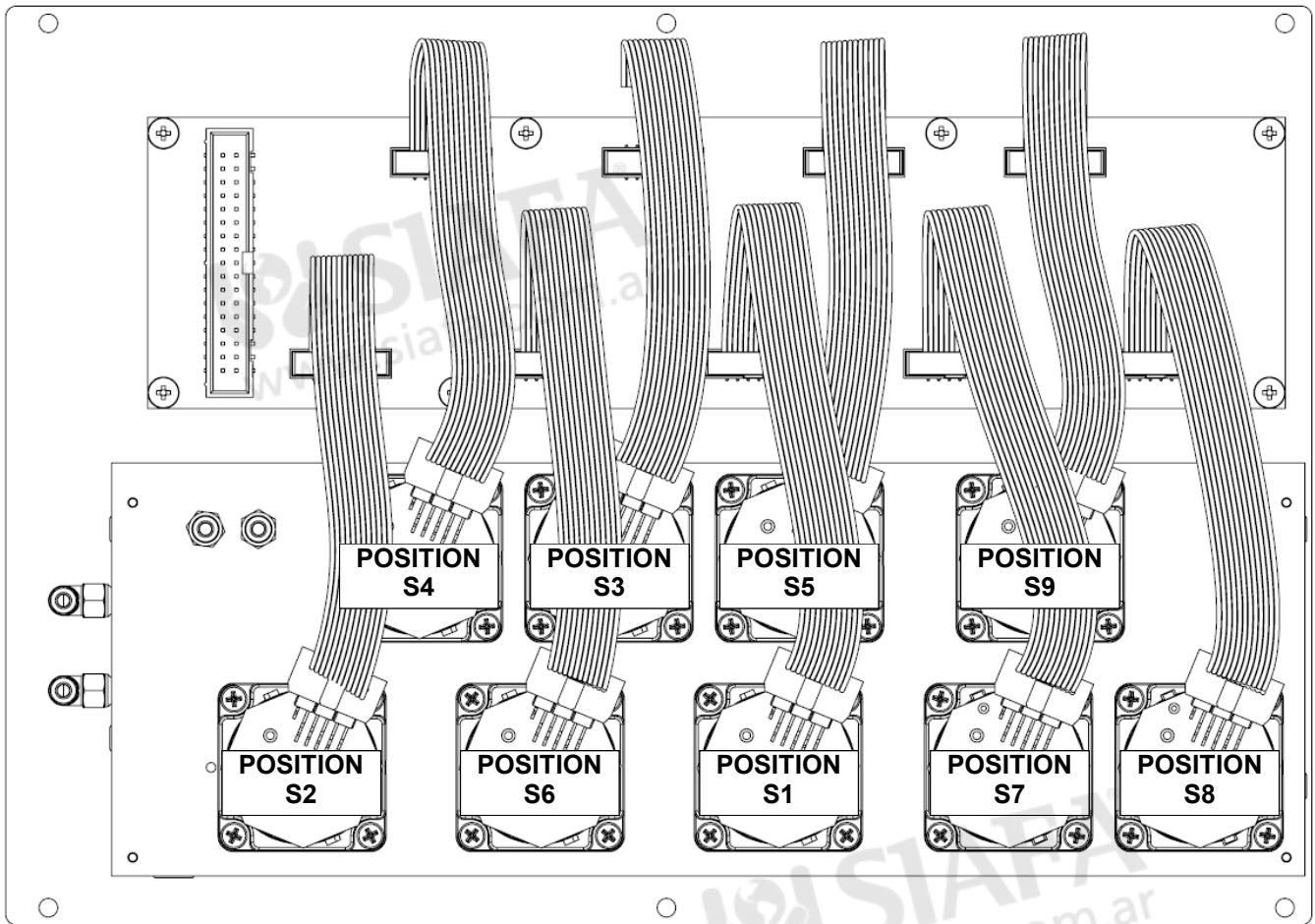

14.2 Sensors list

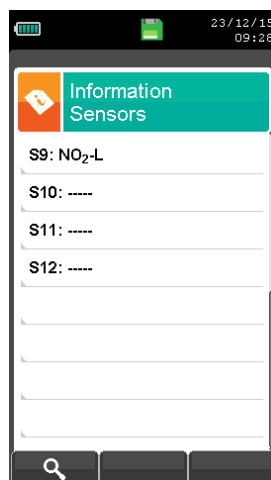
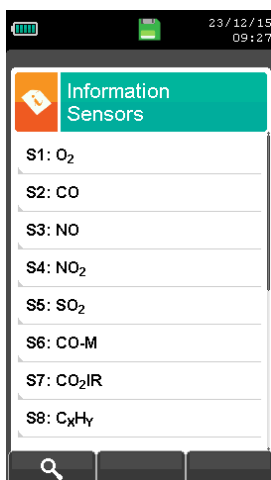

Note

- Positions S10, S11, S12 are related to the infrared bench.
- If two or more identical sensors are installed, the measured gas (i.e. NO2, SO2, ..) and the installation position (S2, S5, ..) will be shown on the display.

14.3 Sensor types and relevant positioning

CODE \ POSITION	S1	S2	S3	S4	S5	S6	S7	S8	S9
Flex-Sensor O₂ Cod. AACSE15R	✓	✓	✓				✓		
Flex-Sensor CO+H₂ Cod. AACSE12		✓							
Flex-Sensor NO Cod. AACSE10	✓	✓	✓				✓		
Flex-Sensor NO₂ Cod. AACSE14	✓	✓	✓	✓	✓	✓	✓	✓	✓
Flex-Sensor SO₂ Cod. AACSE13	✓	✓	✓	✓	✓	✓	✓	✓	✓
Flex-Sensor CO 100.000 ppm Cod. AACSE17	✓	✓	✓	✓	✓	✓	✓	✓	✓
Flex-Sensor CO 20.000 ppm Cod. AACSE18	✓	✓	✓	✓	✓	✓	✓	✓	✓
Flex-Sensor CO₂ 0-20% v/v Cod. AACSE41	✓	✓	✓	✓	✓	✓	✓	✓	✓
Flex-Sensor CxHy 0-5.00% vol. riferito al CH₄ Cod. AACSE39	✓	✓	✓	✓	✓	✓	✓	✓	✓
Flex-Sensor CO+H₂ low range Cod. AACSE24		✓							
Flex-Sensor NO low range Cod. AACSE25	✓	✓	✓				✓		
Flex-Sensor NO₂ low range Cod. AACSE26	✓	✓	✓	✓	✓	✓	✓	✓	✓
Flex-Sensor SO₂ low range Cod. AACSE28	✓	✓	✓	✓	✓	✓	✓	✓	✓
Flex-Sensor CO₂ 0-50% v/v Cod. AACSE47	✓	✓	✓	✓	✓	✓	✓	✓	✓
Flex-Sensor H₂S Cod. AACSE35	✓	✓	✓	✓	✓	✓	✓	✓	✓
Flex-Sensor NH₃ Cod. AACSE56	✓	✓	✓	✓	✓	✓	✓	✓	✓
Flex-Sensor H₂ 2000ppm Cod. AACSE57	✓	✓	✓	✓	✓	✓	✓	✓	✓
Flex-Sensor H₂ 40000ppm Cod. AACSE78	✓	✓	✓	✓	✓	✓	✓	✓	✓

14.4 Gas sensors life

The gas sensors used in this instrument are electrochemical: thus, when the relative gas is detected, a chemical reaction takes place inside them that generates an electrical current.

The electrical current acquired by the instrument is then converted into the corresponding gas concentration. Sensor life is strongly related to the consumption of the reagents within.

Sensor characteristics diminish as the reagents are consumed and when these have been used up completely the sensor must be replaced. The sensors must be recalibrated on a regular basis to assure measuring accuracy: recalibration can only be performed by a qualified SEITRON service centre. Chart 14.5 illustrates the characteristics inherent to each sensor.

14.5 Table gas sensors life

CODE	MEASURED GAS	IDENTIFYING COLOR ⁽¹⁾	AVERAGE LIFE	RECALIBRATION
Flex-Sensor O₂ Cod. AACSE15R	O ₂ Oxygen		>24 months	not required
Flex-Sensor CO+H₂ Cod. AACSE12	CO Carbon Monoxide	Red	48 months	yearly ⁽²⁾
Flex-Sensor NO Cod. AACSE10	NO Nitrogen Oxide	Orange	48 months	yearly ⁽²⁾
Flex-Sensor NO₂ Cod. AACSE14	NO ₂ Nitrogen Dioxide	White	36 months	yearly ⁽²⁾
Flex-Sensor SO₂ Cod. AACSE13	SO ₂ Sulphur Dioxide	Green	36 months	yearly ⁽²⁾
Flex-Sensor CO 100000 ppm Cod. AACSE17	CO Carbon Monoxide	Purple	48 months	yearly ⁽²⁾
Flex-Sensor CO 20.000 ppm Cod. AACSE18	CO Carbon Monoxide	Blue	48 months	yearly ⁽²⁾
Flex-Sensor CxHy 0-5.00% vol. ref. to CH₄ Cod. AACSE39	CxHy Unburnt Hydrocarbons		48 months	yearly ⁽²⁾
Flex-Sensor CO+H₂ low range Cod. AACSE24	CO Carbon Monoxide	Red	48 months	yearly ⁽²⁾
Flex-Sensor NO low range Cod. AACSE25	NO Nitrogen Oxide	Orange	48 months	yearly ⁽²⁾
Flex-Sensor NO₂ low range Cod. AACSE26	NO ₂ Nitrogen Dioxide	White	48 months	yearly ⁽²⁾
Flex-Sensor SO₂ low range Cod. AACSE28	SO ₂ Sulphur Dioxide	Green	48 months	yearly ⁽²⁾
Flex-Sensor CO₂ 0-20% Cod. AACSE41	CO ₂ Carbon Dioxide		>48 months	yearly ⁽²⁾
Flex-Sensor CO₂ 0-50% Cod. AACSE47	CO ₂ Carbon Dioxide		>48 months	Yearly ⁽²⁾
Flex-Sensor H₂S Cod. AACSE35	H ₂ S Hydrogen Sulphide		36 months	yearly ⁽²⁾
Flex-Sensor NH₃ Cod. AACSE56	NH ₃ Ammonia		48 months	yearly ⁽²⁾
Flex-Sensor H₂ 2000ppm Cod. AACSE57	H ₂ Hydrogen		24 months	yearly ⁽²⁾
Flex-Sensor H₂ 40000ppm Cod. AACSE78	H ₂ Hydrogen		24 months	yearly ⁽²⁾

Note:

(1) Colored dot on the sensor electronic board.

(2) UNI 10389-1 standard requires for the instrument calibration once per year to be performed in a laboratory authorized to issue calibration certificates.

14.6 Expandability to 9 sensors

The CHEMIST 900 combustion analyzer can be expanded up to 9 cells.

EXAMPLE OF AN EXPANDABLE 6 SENSORS CHEMIST 900

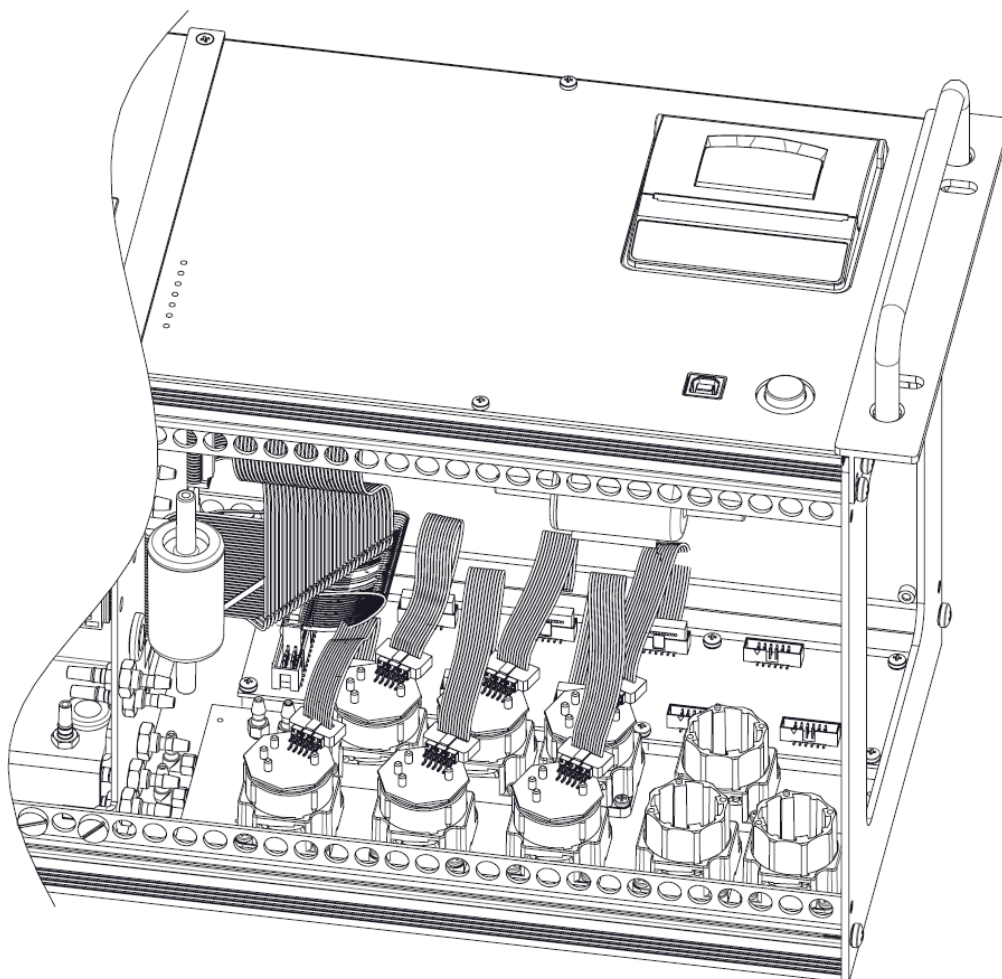

The upgrading of the number of sensors can be easily done by the user by performing the following directions:

- The expandable instruments are arranged in a way to accept up to a maximum of 9 sensors.
- Identify, with the help of paragraph 14.3 "[Sensor types and relevant positioning](#)", the sensor(s) which must be added to the existing configuration (Seitron delivers all FLEX-series sensors already pre-calibrated and ready to use).
- To install the new sensors follow all the steps described in the paragraph 'MAINTENANCE' in "[gas sensors replacement](#)".



THE INSTRUMENT AUTOMATICALLY DETECTS WHEN AN ADDITIONAL SENSOR IS INSTALLED OR HAS BEEN REMOVED. THE SCREEN 'SENSORS CONFIGURATION' ALLOWS TO ACCEPT THE NEW PROPOSED CONFIGURATION OR TO IGNORE THE CHANGE DETECTED. IN THIS SCREEN ARE SHOWN, FOR EACH POSITION, THE FOLLOWING MESSAGES:

EXAMPLE OF AN 'NO' SENSOR IN POSITION 3 REPLACED WITH AN 'NO2' SENSOR:

NO→NO₂ A SENSOR DIFFERENT FROM THE PREVIOUS ONE HAS BEEN DETECTED.

EXAMPLE OF A NEW SENSOR INSTALLED IN POSITION 4 (PREVIOUSLY NOT PRESENT):

SO₂→□ A NEW SENSOR HAS BEEN DETECTED.

14.7 CxHy sensor for measurement of the unburnt hydrocarbons (pellistor)

The unburnt hydrocarbons are chemicals produced by an incomplete combustion of molecules (hydrocarbons) made of Carbon and Hydrogen.

These are usually named as HC or (better) CxHy: when this is filled with the actual values for the number of C and H atoms, the actual type of fuel is exactly defined. In case of Methane, as an example, the correct formula is CH4. In the following table is shown the cross sensitivity of the CxHy sensor when exposed to fuels different from Methane (CH4), assumed as 1.00.

GAS / VAPOR	RELATIVE RESPONSE (with respect to Methane)	GAIN ADJUSTMENT
Ethanol	0.75	1.33
Iso-Butane	0.60	1.67
Methane	1.00	1.00
Methanol	1.00	1.00
n-Butane	0.60	1.67
n-Heptane	0.45	2.22
n-Hexane	0.50	2.00
Propane	0.70	1.43

Calculation example:

Type of gas: iso-butane
 Relative response: 0.6
 Gain adjustment: 1.67
 Reading value (related to methane): 1.34

Value = reading value x gain adjustment

Example: 1.34 x 1.67 = 2.24

WARNING

Gases that contain acidic or silicone compounds (HMDS) can irreversibly damage the sensor.

14.7.1 Installing the CxHy sensor

When the CxHy (position S3/S4) is mounted in the instrument, it is mandatory to configure the autozero by setting it at 180 seconds, in order to allow for a proper pre-heating of the sensor itself.

Configuration → Analysis → Autozero (See section 9.2.8)

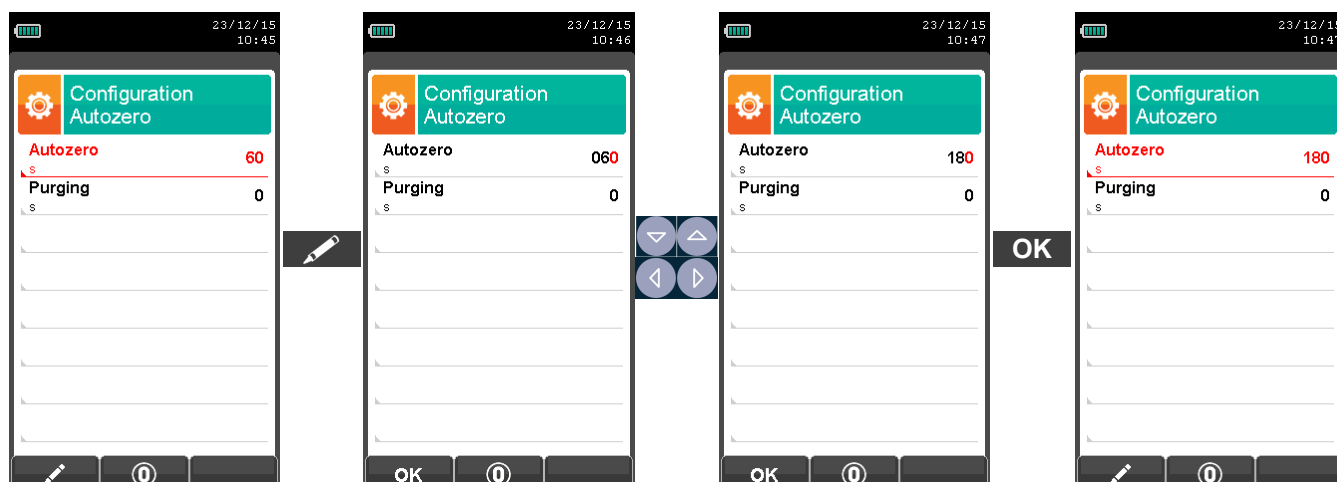

14.8 CO₂ sensor for Carbon Dioxide measurement in combustion processes (NDIR - Single Cell)

Carbon Dioxide (CO₂) is the result of combustion of an organic compound in presence of a quantity of oxygen sufficient to complete its oxidation. In nature, it is also produced by aerobic bacteria during the process of alcoholic fermentation and is the by product of respiration.

Many combustion processes are defined with 'mixed fuel' and is therefore difficult to calculate the amount of CO₂ produced. To avoid this drawback, the only way to know the amount of CO₂ produced in a combustion process with 'mixed fuel' is to measure the CO₂ with special NDIR sensors.

14.8.1 Installing the CO₂ sensor

When the CO₂ (position S3/S4) is mounted in the CHEMIST 900, it is mandatory to configure the autozero by setting it at 60 seconds, in order to allow for a proper pre-heating of the sensor itself.

Configuration → Analysis → Autozero ([See section 9.2.8](#))

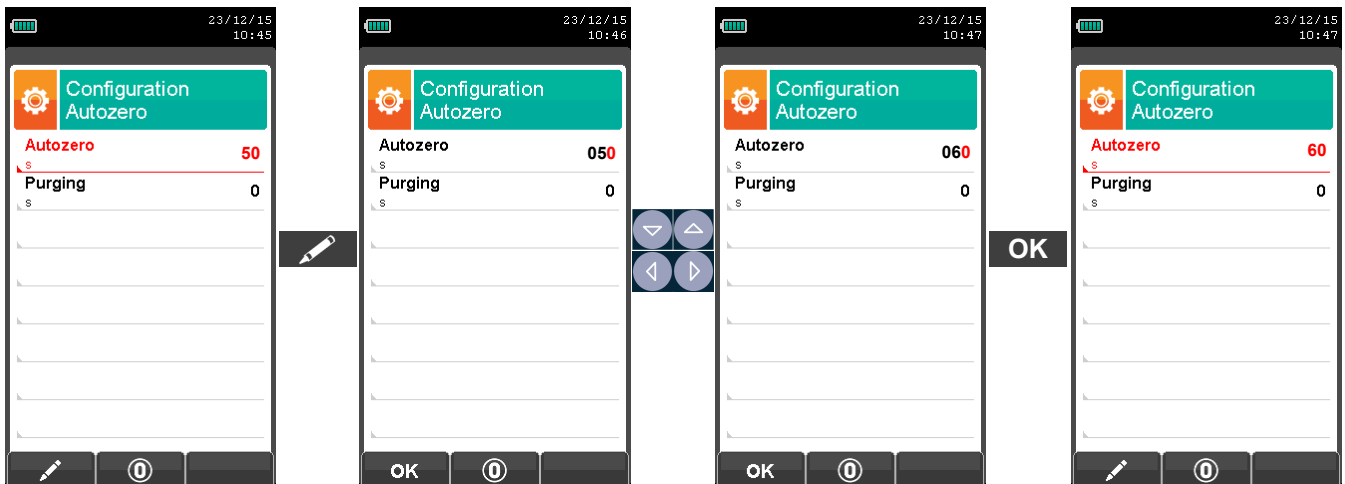

14.9 NH₃ sensor for ammonia gas measurement in combustion processes



USE ONLY WITH THE SMOKE PROBE FOR INDUSTRIAL ENGINES COMPLETE WITH SYNTHORIZED STEEL FILTER ON THE TIP AND FILTERED CARTRIDGE IN HDPE IN THE WATER TRAP.

This sensor measures the presence of ammonia (NH₃) in combustion gases and, since this gas is easily soluble in H₂O some precautions are necessary; the measure must be performed:

- For short periods of time (1-2 hours).
- Using only the flue gas sampling probe for industrial engines as it is equipped with a filter on the tip, suitable to perform this measurement. This filter creates a dry "pre-filtration" in order to retain the humidity that actually cancels the NH₃ content present in the fumes, making it not measurable. The filter being inserted inside the chimney is heated by the fumes and kept warm; the gas that passes through the filter does not form condensation and therefore allows an accurate measurement of ammonia. The filter inserted in the chimney is called "hot filter".
- It is necessary to replace the paper filters on the two anti-condensation traps external from the instrument, with two HDPE filters (to be sold separately), which retains the dust particles but not the residual humidity and therefore ammonia.

The procedure to replace the filters in the anti-condensation trap is described in the following:

1 Unscrew the transparent cap.

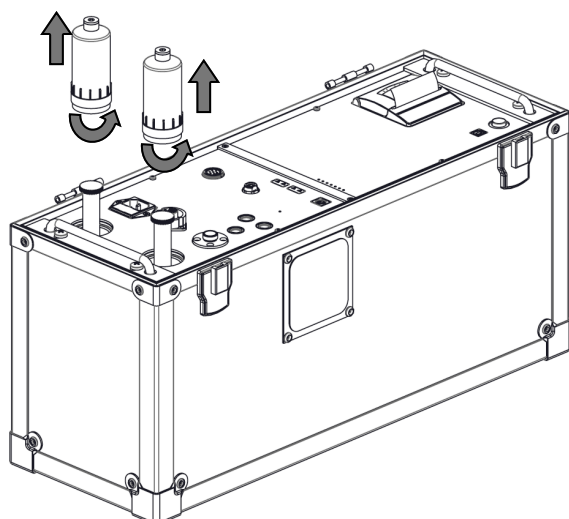

2 Un screw the anti dust filter.

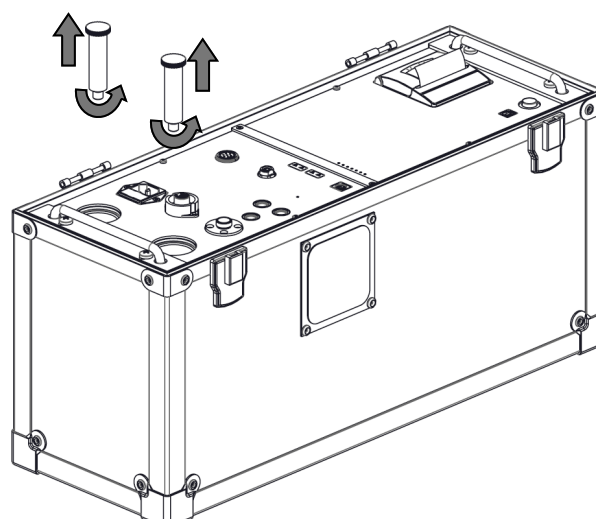

3 Replace the paper filter with the HDPE filter and screw it back on its seat.

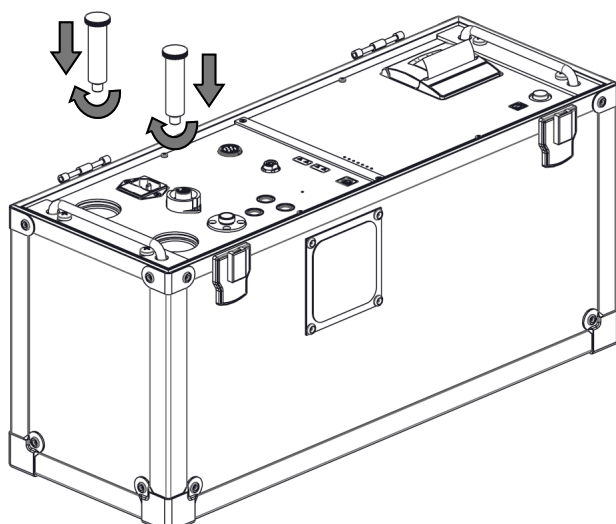

4 Screw back the transparent cap in its seat.

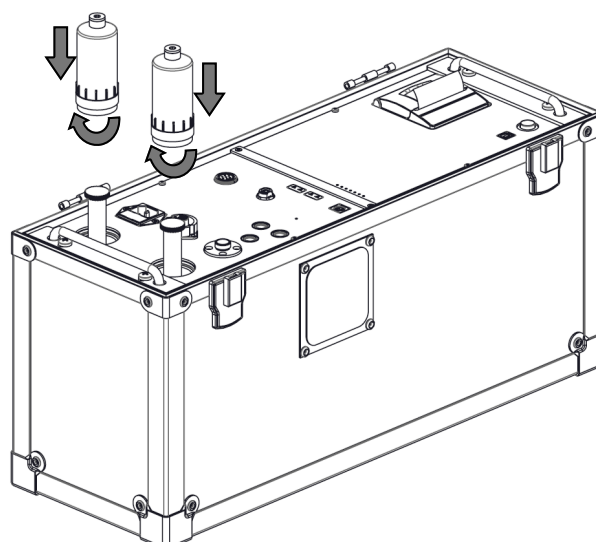

14.10 Infrared bench

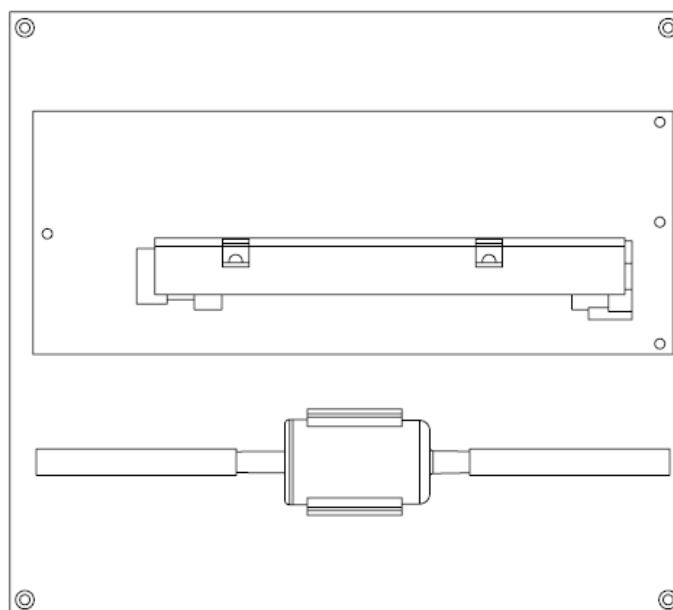

An infrared bench for the detection of gases based on (NDIR) infrared spectroscopy can be installed on **CHEMIST 900**. By this system it is possible to simultaneously detect CO, CO₂ and C_xH_y.

An additional dust filter is fitted along the pneumatic circuit before the IR bench.

The principle is the (NDIR) nondispersive infrared absorption at two wavelengths, stability over time, no interference with other compounds of the process, very fast response and quick return to zero value even after measuring concentrations up to the maximum measurement limit.

Gases absorb light at specific wavelengths, typically in the IR. An NDIR system includes: an IR light source, a chamber which contains the gas sample to be analyzed and a detector equipped with an optical filter. The light goes through the chamber and the gas sample will absorb it at a specific wavelength (i.e. 4.26µm for CO₂) or in specific bands.

The filter is the nondispersive optical component which allows the detector to unequivocally identify the gas according to the absorption spectrum pattern. The narrower the filter bandwidth the higher is the specificity of the sensor. The intensity of light (at a specific wavelength) that reaches the detector is inversely proportional to the relevant gas concentration. The signal picked up by the detector is then processed by the downstream electronics in order to have the concentration of CO, CO₂ or C_xH_y.

15.1 Ordinary maintenance

This instrument has been designed and made using high quality components. A systematic and proper maintenance shall prevent the occurrence of any malfunctioning and increase the overall life cycle of your device.

The operator is recommended to carry out the following basic operations:

- Avoid any great thermal shock before using the instrument or possibly wait that its temperature is within the operating parameters.
- Do not extract flue gas directly without a dust/condensate trap.
- Do not exceed the sensor overload thresholds.
- When the analysis is completed, disconnect the water trap and hoses and let the analyzer purge with clean fresh air for at least 5 to 10 minutes, or at least until the displayed parameters return to their original values in air.
- Clean the filter unit as necessary, by replacing the dust filter and blowing air inside the tube of the sampling probe to release any condensate.

Do not use abrasive cleaners, solvents or other aggressive detergents to clean the instrument.

15.2 Scheduled Maintenance

Send the instrument to the SERVICE CENTER to be thoroughly cleaned and checked at least once a year. SEITRON highly qualified personnel is always at your disposal for any commercial or technical information and implementation or maintenance issues.

The service center is always ready to timely return the instrument like brand new. Calibrations are carried out using gases and instruments in compliance with National and International Sampling standards.

The annual test and certificate of calibration guarantee the proper operation of the instrument as provided by the UNI 10389-1 standard and are mandatory for users who require ISO 9000 certification.

15.3 Cleaning of the sampling probe

After using the sampling probe and before placing it in its case, it is recommended to thoroughly clean it as follows:

- Disconnect the sampling probe from the instrument.
- Blow clean air in both tubes of the probe to release any remaining condensate.



15.4 Cleaning the sampling probe for industrial engines

After using the sampling probe for industrial engines, it is recommended to thoroughly clean it as follows:

- Disconnect the sampling probe from the instrument.
- Remove the filter from the probe tip by loosening the nut shown by the arrow.

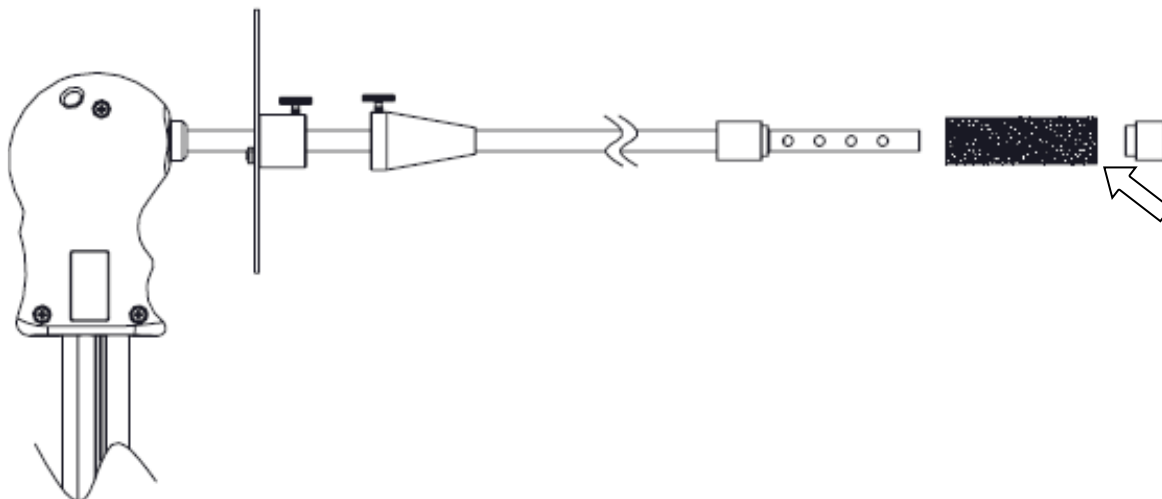

- Blow clean air in both tubes of the probe (shown by the arrow) to release any residual condensate.



- Clean the filter in an ultrasonic bath or by using solvent and steel wire brushes.



- To reassemble the probe logically reverse this procedure.

15.5 Cleaning the heated sampling probe

After using the sampling probe and before placing it in its compartment (available accessory) it is recommended to thoroughly clean it as follows :

- Disconnect the sampling probe from the instrument.
- Disconnect the tube from the heated head and blow clean air in the tube of the probe to release any remaining condensate.

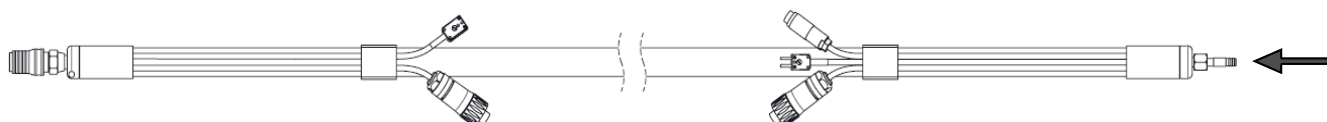

- Open the heated head by unscrewing the body, remove the stainless steel filter and blow clean air in the internal compartment of the filter holder.

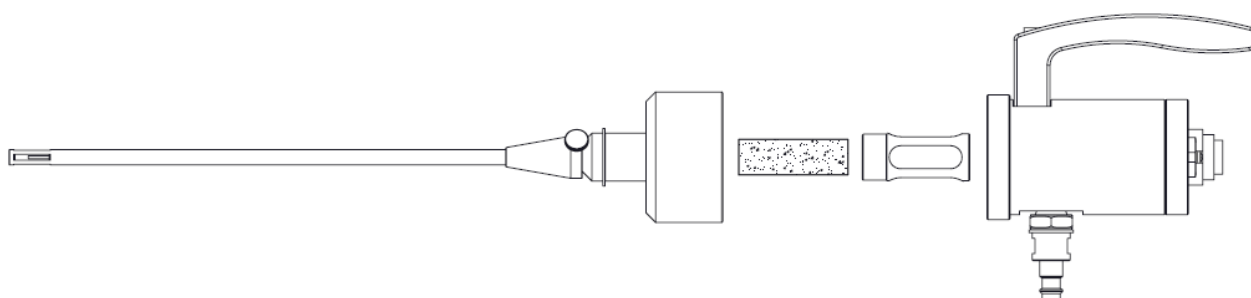
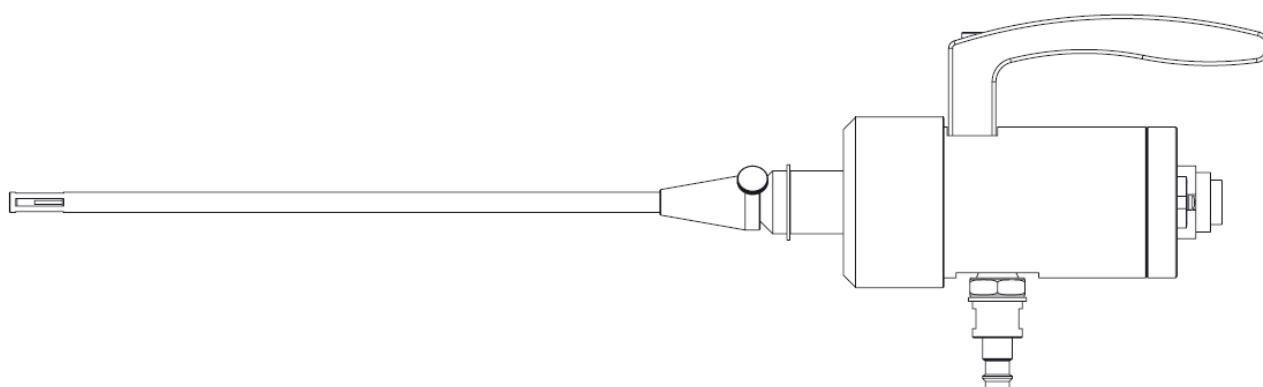

- Clean the filter in an ultrasonic bath or by using solvents and steel wire brushes.



- To reassemble the probe logically reverse this procedure.

15.6 Cleaning the external dust filters

If the external particulate & dust filters have large accumulations of particulates, ash, & dust and/or have any cracks in them, then replace these filters as shown below.

1 Unscrew the transparent cover.

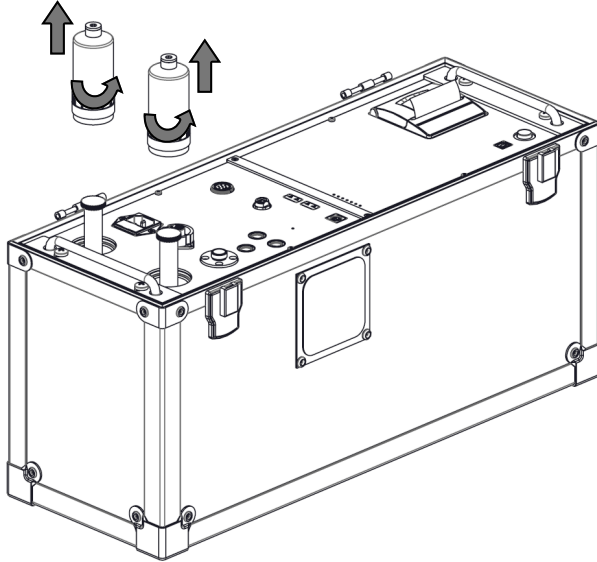

2 Unscrew the dust filter

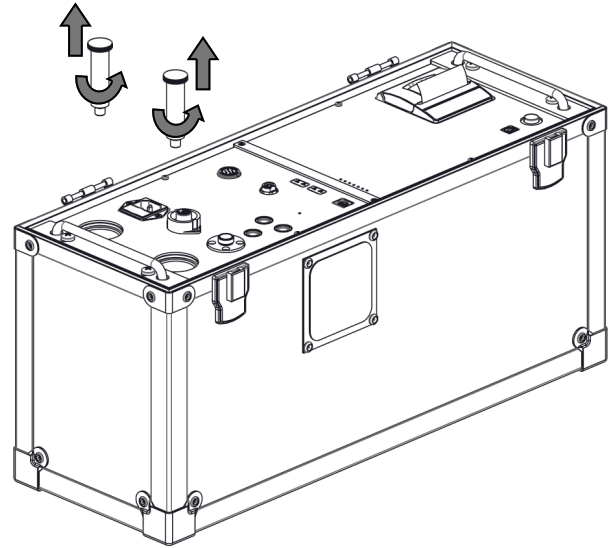

3 Clean the cover inside by using compressed air, soap and water or ultrasonic cleaner (do not use solvents or thinners as the case/container is made of PVC plastic material).

4 Replace the dust filter with a new one.

5 To reassemble the filter logically reverse this procedure.

15.7 Replacing the gas sensors

The gas sensors of the instrument shall be periodically replaced ([see the following table](#)) with new or recalibrated sensors.

The user can easily perform this replacement operation according to the following instructions:

- 1 Gain access to the internal parts of the instrument, as explained in [section 5.3 "Access to internal components"](#).
- 2 Locate the sensor to be replaced; here is an example of a connected sensor to be replaced (with the electrical connector still coupled).

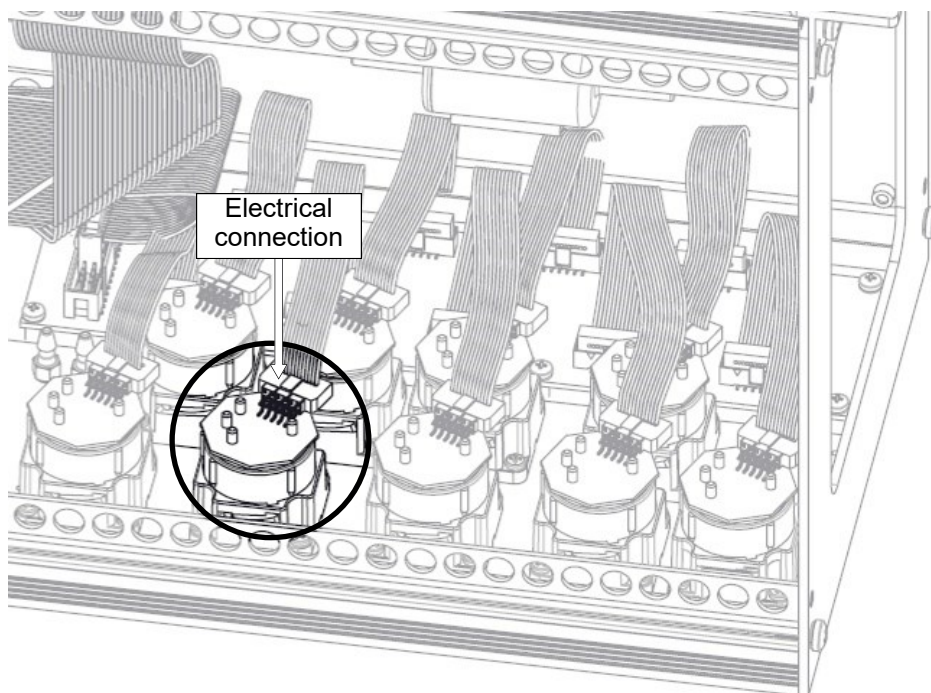

- 3 Disconnect the sensor to be replaced; here is an example of a disconnected sensor to be replaced (the electrical connector has been disconnected).

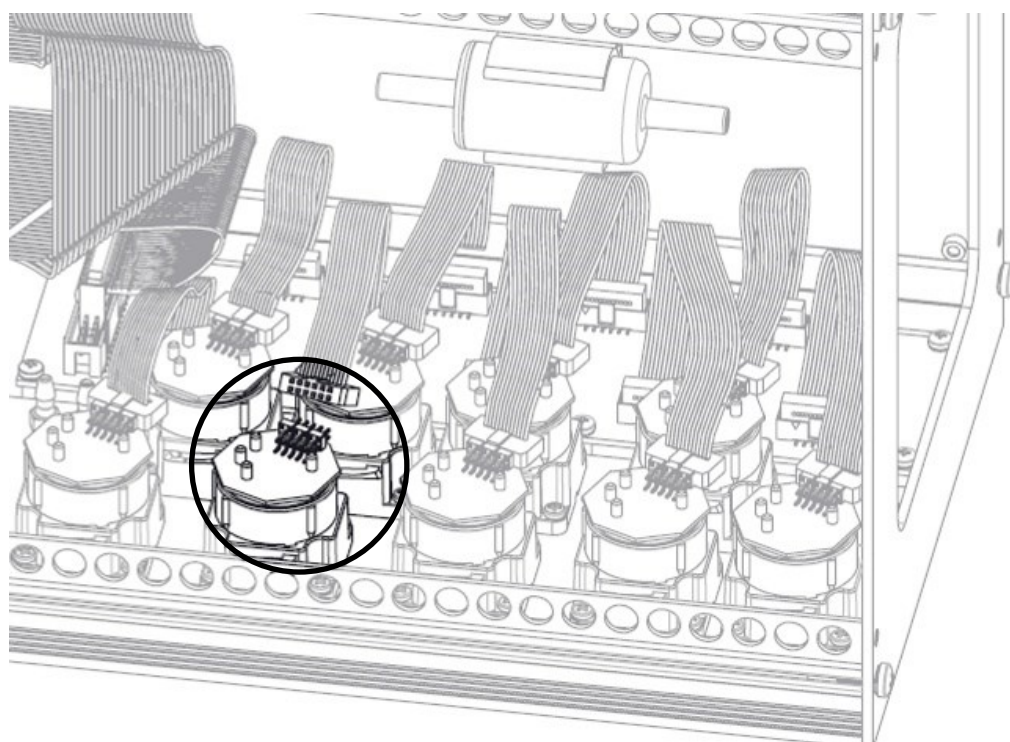

- 4** The sensor is bayonet-connected to its socket; rotate it counter-clockwise to remove it. Here is an example of a rotated sensor.



While rotating the sensor, take care not to exert any pressure on the printed circuit board mounted on the top of the sensor: exert pressure only onto the plastic body.

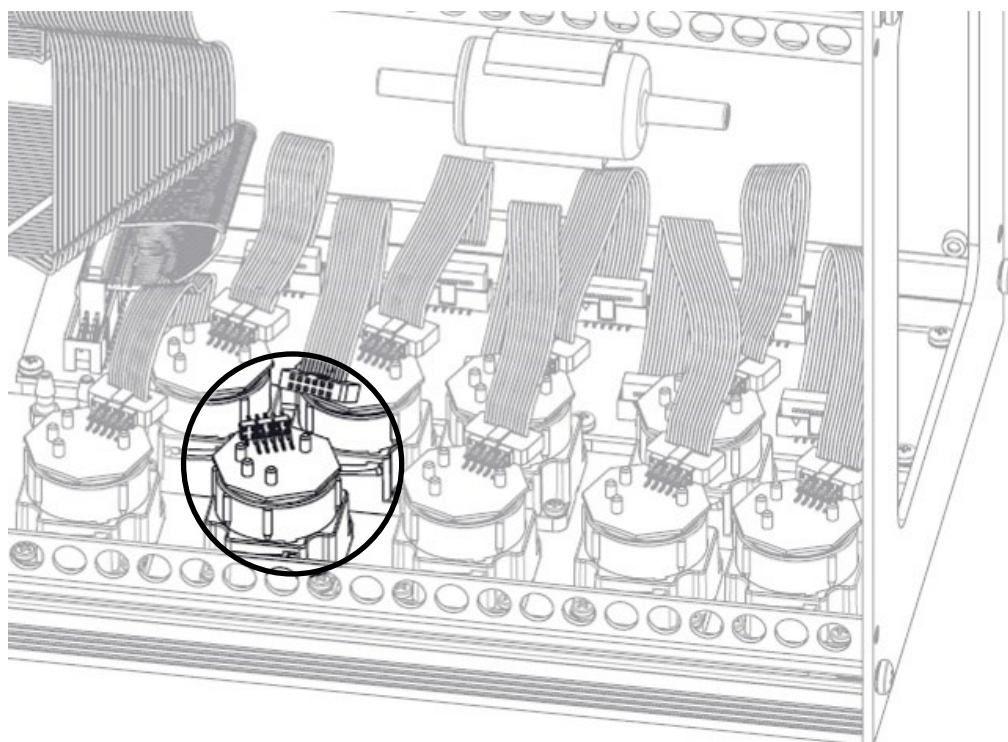

- 5** After rotating the sensor, pull it upward; here is an example of the sensor compartment with a sensor removed.

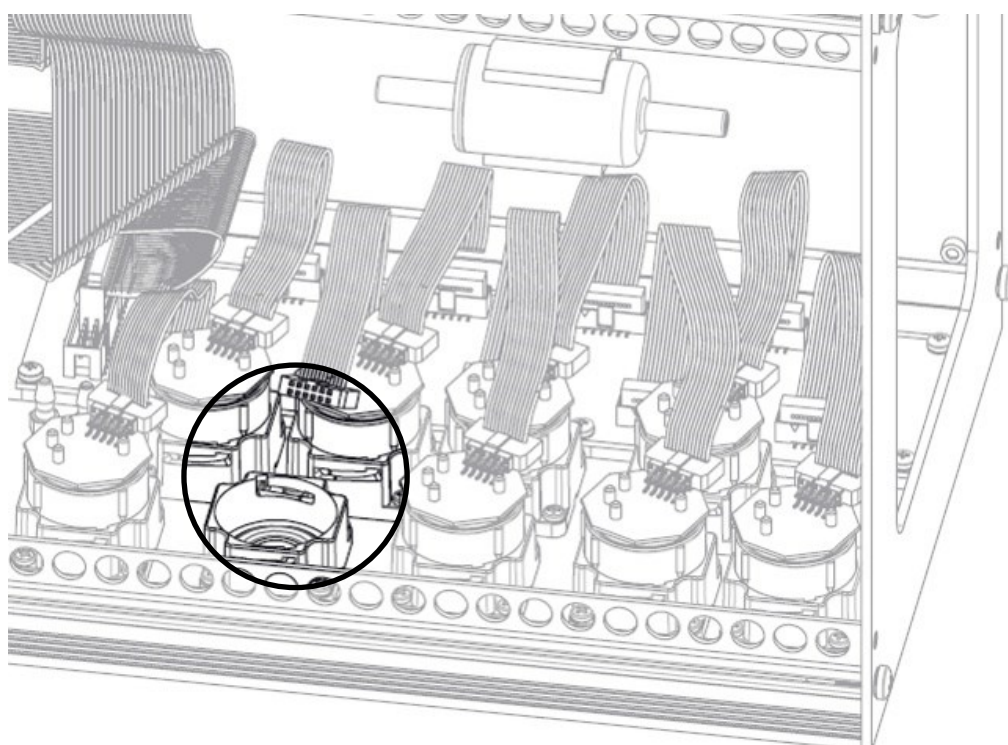

- 6** Fit the new sensor again taking care the electric connection is turned to the outside the instrument, not the inside (See point 4).

- 7 Rotate the sensor clockwise until hearing a click (See point 3).



While rotating the sensor, take care not to exert any pressure onto the printed circuit above: exert pressure onto the plastic body only.

- 8 Reconnect the sensor (See point 2).
- 9 Reinsert the instrument assembly into its case, as described in [section 5.3 " Access to the internal components"](#)

Turn on the instrument to check the new sensor works correctly through the menu "Sensor Troubleshooting". It is normal if a newly installed sensor gives a 'current error': it is necessary to wait some time, so that the sensor polarization can settle. The table here below shows the minimum settling time for each sensor.

CODE	MEASURED GAS	SETTLING TIME
Flex-Sensor O₂ Cod. AACSE15R	O ₂ Oxygen	2 hours
Flex-Sensor CO+H₂ Cod. AACSE12	CO Carbon Monoxide	2 hours
Flex-Sensor CO+H₂ low range Cod. AACSE24	CO Carbon Monoxide	2 hours
Flex-Sensor CO 100.000 ppm Cod. AACSE17	CO Carbon Monoxide	2 hours
Flex-Sensor CO 20.000 ppm Cod. AACSE18	CO Carbon Monoxide	2 hours
Flex-Sensor NO Cod. AACSE10	NO Nitrogen Oxide	48 hours ⁽¹⁾
Flex-Sensor NO low range Cod. AACSE25	NO Nitrogen Oxide	48 hours ⁽¹⁾
Flex-Sensor NO₂ Cod. AACSE14	NO ₂ Nitrogen Dioxide	2 hours
Flex-Sensor NO₂ low range Cod. AACSE26	NO ₂ Nitrogen Dioxide	2 hours
Flex-Sensor SO₂ Cod. AACSE13	SO ₂ Sulphur Dioxide	2 hours
Flex-Sensor SO₂ low range Cod. AACSE28	SO ₂ Sulphur Dioxide	2 hours
FLEX-Sensor C_xH_y 0-5.00% vol. referred to CH₄ Cod. AACSE39	C _x H _y Unburnt Hydrocarbons	1/2 hour
Flex-Sensor CO₂ 0 .. 20% vol. Cod. AACSE41	CO ₂ Carbon Dioxide	2 hours
Flex-Sensor CO₂ 0 .. 50% vol. Cod. AACSE47	CO ₂ Carbon Dioxide	2 hours
Flex-Sensor H₂S 500 ppm Cod. AACSE35	H ₂ S Hydrogen Sulphide	2 hours
Flex-Sensor NH₃ 500 ppm Cod. AACSE56	NH ₃ Ammonia	24 hours
Flex-Sensor H₂ 2000 ppm Cod. AACSE57	H ₂ Hydrogen	2 hours
Flex-Sensor H₂ 40000 ppm Cod. AACSE78	H ₂ Hydrogen	2 hours

Note:

(1) 48 hours settling time is needed; if the sensor is featured with an external polarization battery the settling time becomes 2 hours.

15.8 Replacing the printer paper

Follow these instructions to change the paper roll in the printer.

- ❶ Lift the shiny tile, indicated by the arrow.

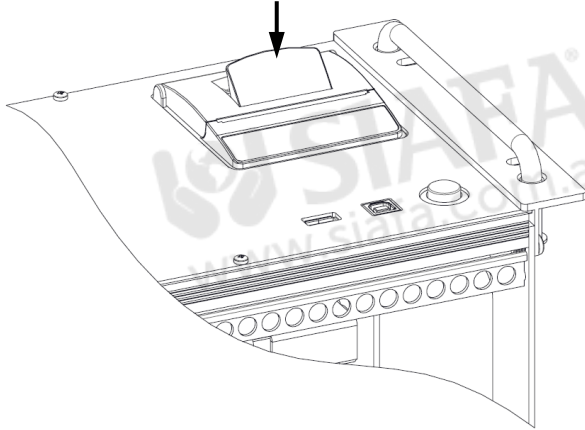

- ❷ Lift the whole block of the lid completely.

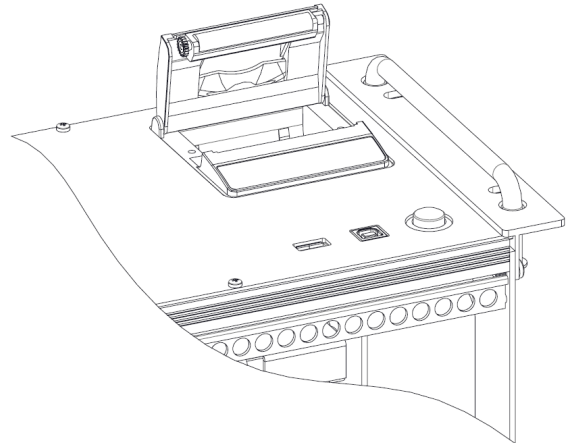

- ❸ Insert the roll of printing paper as shown in the following figures.

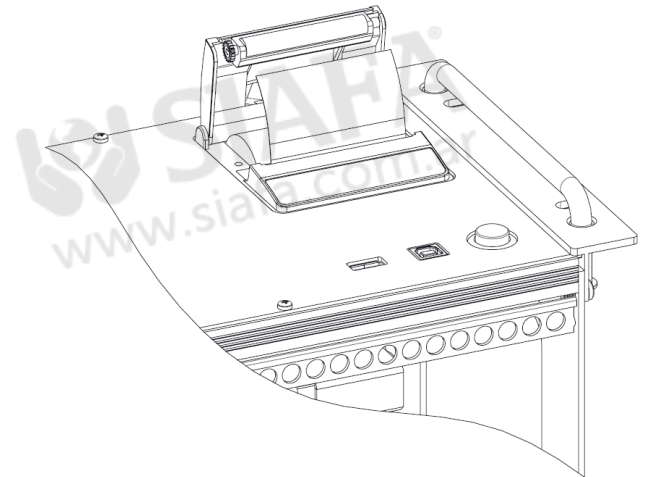
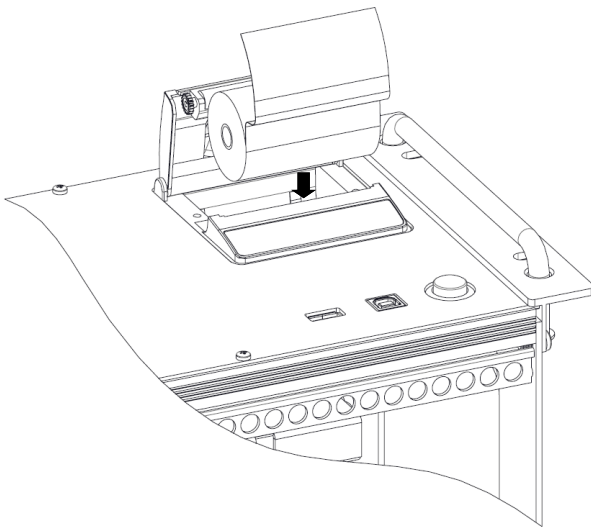

- ❹ Close the whole block of the lid of the printer, pressing it lightly so as to hook it on to the device.

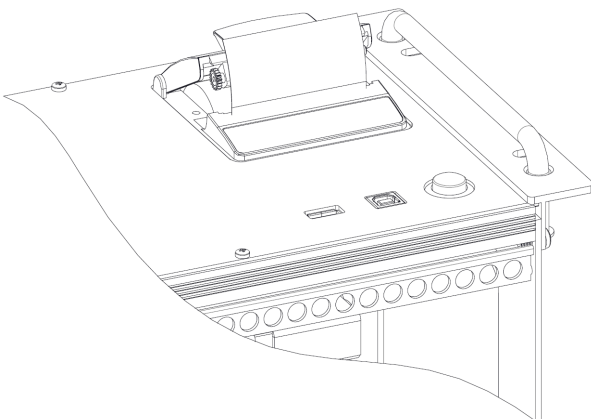

- ❺ At this point it is possible to use the printer. See the parameter. [See section 11 "Print"](#).

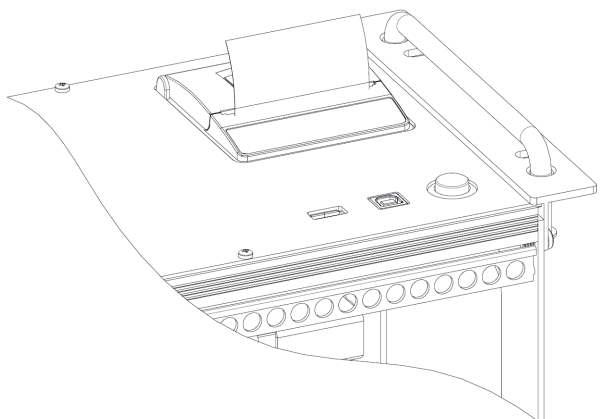

15.9 Firmware Update

The manufacturer periodically releases firmware updates of the instrument in order to correct unavoidable mistakes or improve the instrument performance or add new functions.

This update can be performed by the user by following the simple instructions below.

WARNING:

Since the firmware update could imply a different organization of the data stored in the instrument memory, maintaining the existing analysis data in the instrument is not guaranteed. Therefore it is always mandatory to make the transfer of the analysis from the instrument to the PC prior to the firmware update procedure.

Moreover, for the same reasons, it is absolutely mandatory that the management software tool installed on the PC is updated to a version compatible with the firmware version installed on the instrument.

Instructions to update the combustion analyzer with a new firmware:

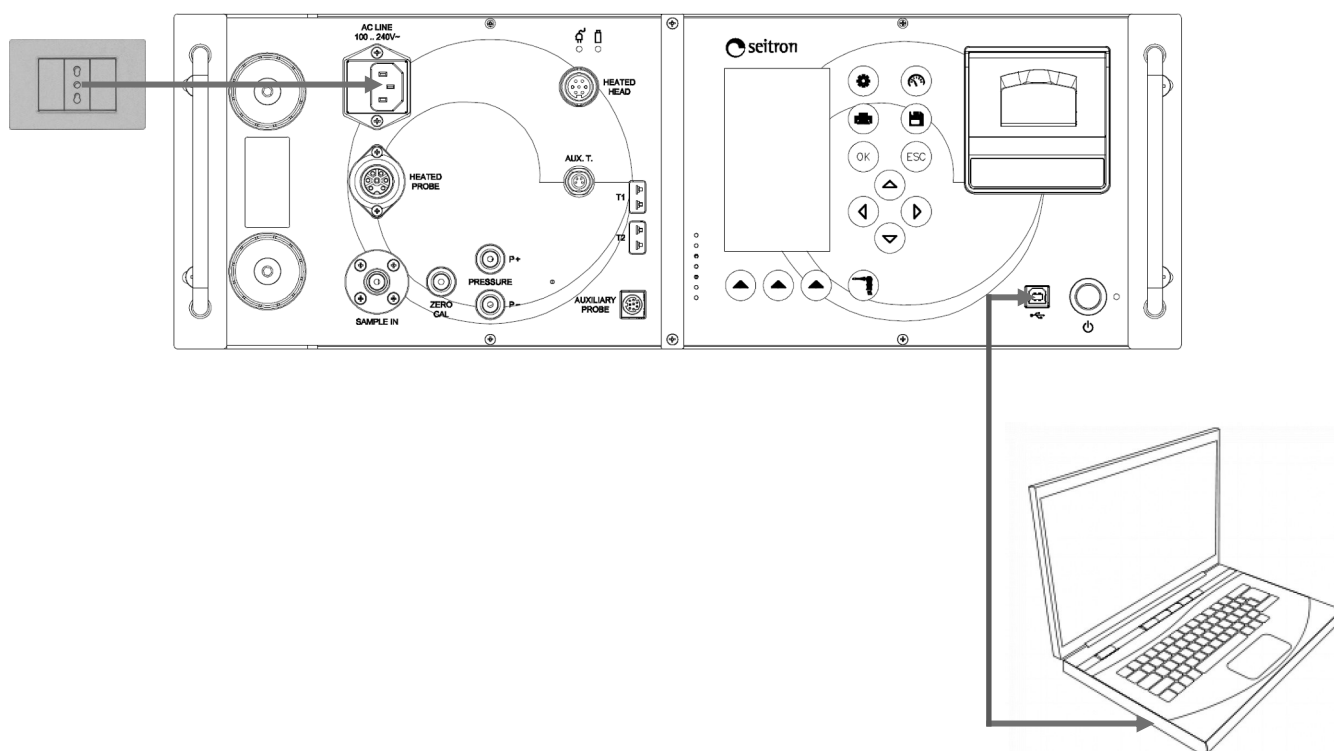

1. Log in to the website www.seitron.it and download the firmware file available in the "combustion analyzers" section. This file is in a compressed version .zip.
2. Unzip the file thus obtaining the contents of the .zip file (extension .srec).
3. Plug in the analyzer to the PC via the USB cable.
4. Connect the analyzer to the mains supply using the cable with the IEC C14 socket supplied
5. Press and hold the ON/OFF key of the combustion analyzer for approx. 10 seconds
6. Release the ON/OFF key; the red led turns on steady
7. Press and hold the ON/OFF key until the red led turns off
8. Release the ON/OFF key; the red led turns on flashing slowly (1 flash/second)
9. The analyzer will be recognized by the operating system as a portable device drive.
10. Copy the firmware file (extension .srec) to the directory of the analyzer.
11. The red led blinks quickly to indicate that the firmware is being updated; wait till the end of the file copy operation.
12. The red led is steady on.
10. The file copy directory will be closed and the analyzer will restart.
11. The analyzer is now updated, it can be powered off and it can be unplugged from the PC and from the mains.

16.1 Troubleshooting guide

SYMPTOM	PROBABLE CAUSES AND REMEDIES
The instrument does not work; when pressing the On/Off key, it does not switch on.	<ul style="list-style-type: none"> a. Press and hold the On/Off key down for longer than 2 seconds. b. The battery is discharged; connect the battery charger to the instrument . c. The battery pack is not connected to the instrument; remove the instrument from its case and insert the connector of the battery pack in the attachment of the printed circuit board. d. The instrument is defective: send it to the service center.
The battery pictogram  , is empty.	Batteries are exhausted. Connect it to the battery charger. If the pictogram is flashing, the shutdown is imminent.
After the instrument turns on, the sensor diagnostic screen displays an error in one or more cells.	Sensor communication error (sensor may be broken or not properly connected) or a change in the sensors installed in relation to the configuration is signaled.
After switching on, the instrument fails to perform the autozeroing.	<ul style="list-style-type: none"> a. If the NDIR bench is installed and enabled, check that the autozero time is set at 70 seconds at least. b. An error has occurred in one or more sensors, see the sensor Diagnostic screen.
The pressure/draft screen signals an error of the piezoresistive temperature compensated pressure sensor.	There is a calibration problem. Send the instrument to the service center.
The analysis screen gives a flue gas temperature (Tf) error.	<ul style="list-style-type: none"> a. The thermocouple is not connected; connect the thermocouple to the analyzer. b. The sensor has been exposed to temperatures greater or lower than its operating temperature range. c. The thermocouple is faulty. Send the complete probe to a service center.
The "----" icon appears in the analysis screen.	The instrument is unable to calculate the numerical value based on the combustion analysis carried out. When the analyzer detects valid combustion data, the "----" icons are replaced with numerical data.
In the analysis screen, the "----" icon appears next to the gases detected by the NDIR bench.	<ul style="list-style-type: none"> a. Check if the NDIR bench is enabled, then switch off and switch the instrument on again. b. If in "Diagnostic→Bench NDIR→Status Register" the CO₂, CO, CH₄ indicate "invalid", it means that the inlet gas is out of the measurement range. c. If in "Diagnostic→Bench NDIR→Status Register" the Sample Temp. indicates "Out of Range", it means that the measurement temperature (detected in the cell /IR tube) is out of the 0-75°C range. d. Warning: in the "Diagnostic→Bench NDIR→Status Register" ignore the messages relating to "Zero Required" and "Proc. In Progress". e. If the problem persists, contact the service center.
"Max. Lim." or "Min. Lim" appears on the analysis screen.	The relevant sensor is detecting a value that is beyond the analyzer measuring range. "Max. Lim" or "Min. Lim." are replaced by numbers when the instrument reveals values that are within the measuring range.

Troubleshooting guide

SYMPTOM	PROBABLE CAUSES AND REMEDIES
The suction pump does not work or the flow is lower than 1,5l/min.	a. The suction flow is blocked. Check that the particulate filter is clean. b. Contact the service center.
The instrument is switched on, but the display seems to be off.	a. Check the display brightness level (see the configuration menu). b. If the problem persists, contact the service center.
During the tightness test a "sensor error" is reported.	Check for the correct connection of the hose to the positive pressure input.
The heated probe is enabled, but the heated tube status displays 'disab. '.	The probe connector is not properly connected to the 'HEATED PROBE' connector of the instrument .
The heated probe is enabled, but the heated tube status displays 'off '.	The instrument is not connected to the power supply.
The heated probe is enabled, but the heated head status displays 'disab. '.	The heated head connector is not properly connected to the 'HEATED HEAD' connector of the instrument .
T head indicates ' no probe '.	The heated head connector is not properly connected to the 'HEATED HEAD' connector of the instrument .
T tube indicates ' no probe '.	The heated head connector is not properly connected to the 'HEATED PROBE' connector of the instrument .
T tube and/or T head indicates ' error '.	a. The connector may be damaged. b. The cable of the temperature sensor may be damaged. Send it to the service center.
The heated probe is enabled, but the tube status and/or the head status and/or Peltier status display ' fault '.	a. Check that the T head, T tube and T Peltier temperatures are within the parameters that have been set. b. Contact the service center.
The Cooler is enabled, but the Peltier status indicates ' fault '.	a. Check that the T Peltier temperature is within the parameter that has been set. b. Contact the service center.
The integrated printer of the instrument does not print.	a. Check that the set printer is the internal printer. b. Start the test print; if the problem persists, contact the service center.

17.1 Spare parts

CODE	DESCRIPTION
AAPB12	Li-Ion 11,1V 5,2Ah battery pack
AARC05	Non-fading printer paper rolls, h=57mm Diam.=35mm
AARC06	Inerasable thermal paper roll for printer, h=58mm Diam.=35mm
AACADX005	Dummy sensor
AACSE15R	FLEX-Sensor O ₂ , pre-calibrated and interchangeable
AACSE12	FLEX-Sensor CO+H ₂ , pre-calibrated and interchangeable
AACSE10	FLEX-Sensor NO/NO _x , pre-calibrated and interchangeable
AACSE14	FLEX-Sensor NO ₂ , pre-calibrated and interchangeable
AACSE13	FLEX-Sensor SO ₂ , pre-calibrated and interchangeable
AACSE17	FLEX-Sensor CO 100.000 ppm, pre-calibrated and interchangeable
AACSE18	FLEX-Sensor CO 20.000 ppm, pre-calibrated and interchangeable
AACSE39	FLEX-Sensor CxHy related to CH ₄ , pre-calibrated and interchangeable
AACSE24	FLEX-Sensor CO+H ₂ low range, pre-calibrated and interchangeable
AACSE25	FLEX-Sensor NO low range, pre-calibrated and interchangeable
AACSE26	FLEX-Sensor NO ₂ low range, pre-calibrated and interchangeable
AACSE28	FLEX-Sensor SO ₂ low range, pre-calibrated and interchangeable
AACSE41	FLEX-Sensor CO ₂ 0-20% v/v, pre-calibrated and interchangeable
AACSE47	FLEX-Sensor CO ₂ 0-50% v/v, pre-calibrated and interchangeable
AACSE35	FLEX-Sensor H ₂ S, pre-calibrated and interchangeable
AACSE56	FLEX-Sensor NH ₃ , pre-calibrated and interchangeable
AACSE57	FLEX-Sensor H ₂ 2000ppm, pre-calibrated and interchangeable
AACSE78	FLEX-Sensor H ₂ 40000ppm, pre-calibrated and interchangeable
AAHH04	Heated head
AATR01	3 meters Electro-heated cable
AAPT01	300 mm tip for smoke probe with heated head
AAPT02	1000 mm tip for smoke probe with heated head
WFILX0022	Syntherized steel filter
WRACH0056	Female quick connector for heated cable; Italian and German profile compatibility
WRACH0057	Male quick connector for heated head; Italian and German profile compatibility
AASY01	Heated head black smoke measurement probe without tip
AAPT03	300 mm tip for black smoke probe with heated head
AAPT04	750 mm tip for black smoke probe with heated head
AS0000MF	Black smoke filter
AASU01	Black smoke measurement scale

17.2 Accessories

CODE	DESCRIPTION
AACCV01	Schuko plug cable.
AACCV04	European plug cable.
AACCV06	US plug cable.
AACDP02	Deprimometer for Draft test.
AACSO01	Probe for measuring the ionization current.
AACSA04	100 mm tip auxiliary temperature probe PT100 4w with 3 mt cable.
AASA08	200 mm tip remote combustion air temperature probe with 2 mt cable.
AASF31	180 mm flue gas sampling probe with 3 mt cable. Working temperature range: 400°C.
AASF32	300 mm flue gas sampling probe with 3 mt cable. Working temperature range: 600°C.
AASF35	750 mm flue gas sampling probe with 3 mt cable. Working temperature range: 800°C.
AASF36	1000 mm flue gas sampling probe with 3 mt cable. Working temperature range: 1200°C.
AASX03	750 mm flue gas sampling probe for industrial engines with 3 mt cable.
AASX04	Special smoke probe for the black smoke measurement with 300 mm tip and 3,5 m cable.
AASX05	Special smoke probe for the black smoke measurement with 750 mm tip and 3,5 m cable.
AACEX02S	3 m extension cable for gas sampling probe.
AASR03	Flue gas sampling probe with heated head, 300 mm tip and electro-heated 3 mt tube with thermocouple.
AASR04	Flue gas sampling probe with heated head, 1000 mm tip and electro-heated 3 mt tube with thermocouple.
AASP01	Heat protection shield for flue gas sampling probes.
AATT01	'L' shaped Pitot Tube (without Tc-K thermocouple): length 300mm - external \varnothing 6 mm. Supplied with two silicone tubes with length 2 meters.
AATT02	'L' shaped Pitot Tube (without Tc-K thermocouple): length 800mm - external \varnothing 6 mm. Supplied with two silicone tubes with length 2 meters.
AACKP01	Differential pressure kit.
AAKT04	Tightness test kit.
AAPM02	Manual pump kit for smoke measurement.
AASW08	Configuration software on USB flash drive.
AAUA01	USB-A / USB-B adapter cable.
AAEB02	Trunk extension.
AATY01	Trunk trolley.
AATS01	Remote condensate drain hose.
AACKP02	Remote air intake hose.
AAFA03	Filtering cartridge HDPE 100um 12x32mm, 2 pieces.

17.3 Service Centers

Headquarters:

Seitron S.p.A. a socio unico
Via del Commercio, 9/11
36065 Mussolente (VI)
Tel.: +39.0424.567842
Fax.: +39.0424.567849
E-mail: info@seitron.it
<http://www.seitron.it>

Service for North-West Italy

Seitron S.p.A. a socio unico
Via Leonardo da Vinci, 1
I-20090 Segrate (MI)
Tel.: +39.02.83647671
Fax.: +39.02.83647671
E-mail: service.milano@seitron.it
<http://www.seitron.it>

Example of Total analysis report.

COMPANY Ltd.
Park Road, 9
Tel.02/12345678

Oper.: John Smith

Sign.: _____

Test according to
UNI 10389-1
L. 10/1991 and s.m.i.
D.Lgs. 192/2005 and s.m.i.

Chemist 900 X
Serial: 999989

Memory: 01
Analysis: Average
Date: 04/04/14
Time: 10.30

Fuel: Natural gas
Altitude: 0 m
R.H. air: 50 %

O ₂	15.7 %
CO ₂	2.9 ppm
λ,n	4.01
T flue	100.6 °C
T air	27.0 °C
dT	73.6 °C
QS	10.0 %
Es	90.0 %
Ec	0.0 %
Et	90.0 %
CO	23 ppm
NO	14 ppm
NO _x	15 ppm
Ref. O ₂ :	0.0 %
CO ref	92 ppm
Ref. O ₂ :	0.0 %
NO ref	56 ppm
Ref. O ₂ :	0.0 %
NO _x ref.:	60 ppm
Draft	4.5 Pa
T ext.	10.0 °C

Note: -----

Analysis: 1
04/03/16 10.00

O ₂	15.7 %
CO ₂	2.9 %
λ,n	4.01
T flue	100.4 °C
T air	27.0 °C
dT	73.4 °C
QS	10.0 %
Es	90.0 %
Ec	0.0 %
Et	90.0 %
CO	23 ppm
NO	14 ppm
NO _x	15 ppm
Ref. O ₂ :	0.0 %
CO ref	92 ppm
Ref. O ₂ :	0.0 %
NO ref	52 ppm
Ref. O ₂ :	0.0 %
NO _x ref.:	56 ppm
Tiraggio	4.5 Pa
T ext.	10.0 °C

Analysis: 2
04/03/16 10.15

O ₂	15.7 %
CO ₂	2.9 %
λ,n	4.01
T flue	100.6 °C
T air	27.0 °C
dT	73.6 °C
QS	10.0 %
Es	90.0 %
Ec	0.0 %
Et	90.0 %
CO	23 ppm
NO	14 ppm
NO _x	15 ppm
Ref. O ₂ :	0.0 %
CO ref	92 ppm
Ref. O ₂ :	0.0 %
NO ref	56 ppm
Ref. O ₂ :	0.0 %
NO _x ref.:	60 ppm
Draft	4.5 Pa
T ext.	10.0 °C

Analysis: 3
04/03/16 10.20

O ₂	15.7 %
CO ₂	2.9 %
λ,n	4.01
T flue	100.8 °C
T air	27.0 °C
dT	73.8 °C
QS	10.1 %

Es	89.9 %
Ec	0.0 %
Et	89.9 %
CO	23 ppm
NO	14 ppm
NO _x	15 ppm
Ref. O ₂ :	0.0 %
CO ref	92 ppm
Ref. O ₂ :	0.0 %
NO ref	56 ppm
Ref. O ₂ :	0.0 %
NO _x ref.:	60 ppm
Draft	4.5 Pa
T ext.	10.0 °C

Example of Full analysis report.

```

COMPANY Ltd.
Park Road, 9
Tel.02/12345678

Oper.: John Smith

Sign.: _____

Test according to
UNI 10389-1
L. 10/1991 and s.m.i.
D.Lgs. 192/2005 and s.m.i.

Chemist 900 x
Serial: 999989

Memory: 01
Analysis: Average
Date: 04/04/14
Time: 10.30

Fuel: Natural gas
Altitude: 0 m
R.H. air: 50 %

O2                15.9 %
CO2                2.8 ppm
λ,n               4.18
T flue            80.6 °C
T air             26.9 °C
dT               53.7 %
Qs                7.6 %
Es                92.4 %
Ec                0.0 %
Et                92.4 %
CO                27 ppm
NO                11 ppm
NOx               12 ppm
Ref. O2:          0.0 %
CO ref            113 ppm
Ref. O2:          0.0 %
NO ref            46 ppm
Ref. O2:          0.0 %
NOx ref.:         50 ppm
Draft             4.5 Pa
T ext.            10.0 °C

Note: -----
-----
-----
-----
-----
-----
-----

```

Example of Partial Paper print-out.

```

Date: 04/04/14
Time: 10.15

Fuel: Natural gas
Altitude: 0 m
R.H. air: 50 %

O2                15.7 %
CO2                2.9 ppm
λ,n               4.01
T flue            95.4 °C
T air             26.9 °C
dT               68.5 %
Qs                9.3 %
Es                90.7 %
Ec                0.0 %
Et                90.7 %
CO                23 ppm
NO                13 ppm
NOx               14 ppm
Ref. O2:          0.0 %
CO ref            92 ppm
Ref. O2:          0.0 %
NO ref            52 ppm
Ref. O2:          0.0 %
NOx ref.:         56 ppm
Smoke             4.5 Pa
T ext.            10.0 °C

Smoke:           3 1 2
Aver n°:         2

```

Example of Draft Paper print-out.

```

COMPANY Ltd.
Park Road, 9
Tel.02/12345678

Oper.: John Smith

Sign.: _____

Chemist 900 x
Serial: 999989
Memory: 01

Date: 04/04/14
Time: 10.30

Draft             4.5 Pa
T ext.            10.0 °C

Note: -----
-----
-----
-----

```

Example of tightness test report paper print-out.

COMPANY Ltd.
Park Road, 9
Tel.02/12345678

Oper.: John Smith

Sign.: _____

Test according to
UNI 11137: 2019 standard
Indirect method

Chemist 900 X
Serial: 999989
Memory: 01

Date: 03/04/20
Time: 10.30

Stab. duration: 1 min
Test duration: 1 min

Gas comb.: L.P.G.
Test gas: Air
Plant: int

Vimp	25.0 dm ³
P1	10.05 hPa
P2	10.03 hPa
ΔP	-0.02 hPa
Qtest	0.0 dm ³ /h
Qref	0.0 dm ³ /h

Result: compliant

Note: -----

Example of Smoke Paper print-out.

COMPANY Ltd.
Park Road, 9
Tel.02/12345678

Oper.: John Smith

Sign.: _____

Chemist 900 X
Serial: 999989
Memory: 01

Date: 04/04/14
Time: 10.30

Fuel: Diesel

Smoke: 3 1 2
Aver. n°: 2

Note: -----

Example of ambient CO Paper print-out.

COMPANY Ltd.
Park Road, 9
Tel.02/12345678

Oper.: John Smith

Sign.: _____

Chemist 900 X
Serial: 999989
Memory: 01

Date: 04/04/14
Time: 10.30

CO amb 0 ppm

Note: -----

Example of Velocity Paper print-out.

COMPANY Ltd.
Park Road, 9
Tel.02/12345678

Oper.: John Smith

Sign.: _____

Chemist 900 X
Serial: 999989
Memory: 01

Date: 04/04/14
Time: 10.30

Gas: Air

V air	9.11 km/h
Density	1.199 kg/m ³
Altitude	0 ft
T air	25.3 °C
K Pitot	0.980

Note: -----

Coefficients of the fuels and Formulas

The following chart, derived from standard UNI 10389-1, lists the coefficients of the memorised fuels, used for calculating losses and efficiencies.

Coefficients for calculating combustion efficiency									
Fuel	A1	A2	B	CO ₂ t (%)	PCI (KJ/Kg)	PCS (KJ/Kg)	M air (Kg/Kg)	M H ₂ O (Kg/Kg)	V dry gas (m ³ /Kg)
Natural gas	0,660	0,380	0,0100	11,70	50050	55550	17,17	2,250	11,94
Propane	0,630	0,420	0,0080	13,90	45950	49950	15,61	1,638	11,11
L.P.G.	0,630	0,420	0,0080	13,90	45730	49650	15,52	1,602	11,03
Butane	0,630	0,420	0,0080	13,90	45360	49150	15,38	1,548	10,99
Diesel oil	0,680	0,500	0,0070	15,10	42700	45500	14,22	1,143	10,34
Fuel oil	0,680	0,520	0,0070	15,70	41300	43720	13,73	0,990	10,06
Propane air	0,682	0,447	0,0069	13,76	28250	30700	9,13	0,999	6,77
Biogas	0,719	0,576	0,0086	16,81	19200	21250	6,38	0,840	5,82
Pellets (8% RH)	0,740	0,670	0,0071	19,01	18150	19750	6,02	0,660	4,58
Wood (20% RH)	0,761	0,686	0,0089	18,93	15450	17170	5,27	0,700	4,01
Chipped wood	0,8020	0,785	0,0108	20,56	11950	13565	4,20	0,660	3,25
Coal	0,7620	0,691	0,0023	19,06	31400	32300	10,70	0,370	8,14
CO Off gas	0,775	1,164	0,0012	31,55	8610	8735	2,21	0,051	2,14
Olive pits	0,749	0,689	0,0065	19,33	18780	20309	6,290	0,626	4,79
Rice husk	0,777	0,768	0,007	20,738	12558	13633	4,065	0,440	3,152
B20	0,701	0,518	0,0055	15,52	41806	44620	14,04	1,152	13,89

Details of the coefficients of the fuels:

- **CO₂ t:** The value of CO₂ generated by combustion in stoichiometric condition, i.e. without excess Oxygen and therefore maximum.
- **A1, A2, B:** Also please have a look at the Siegert formulas from the European standard EN50379-1 (in the following).
 A1 is the parameter in the Siegert Formula when the O₂ measurement is available.
 A2 is used when the CO₂ measurement is available.
 Note: - Please also consider that in the U.S. usually the A1 parameter is the same as the 'european' A1 BUT divided by 2.
 - For Germany coefficients A1 and A2 are swapped.

Flue gas heat losses are calculated from measured oxygen content according to the relationship:

$$q_A = (t_A - t_L) \times \left(\frac{A1}{21 - O_2} + B \right)$$

Flue gas heat losses are calculated from measured carbon dioxide content according to the relationship:

$$q_A = (t_A - t_L) \times \left(\frac{A2}{CO_2} + B \right)$$

Air index is calculated with the formula:

$\lambda = 21 / (21 - O_2)$, where O₂ is the oxygen residual concentration in the combustion smokes.

Air excess is calculated with the formula:

$$e = (\lambda - 1) * 100$$

- **CO conv:** Conversion coefficient from ppm to mg/KWh. It can be expressed as a function of the gas density (CO in this case) and the volume of the dry smoke.
- **NO conv:** Same as CO conv, but for NO.
- **NO_x conv:** Same as CO conv, but for NO_x.
- **SO₂ conv:** Same as CO conv, but for SO₂.
- **PCI:** Potere Calorifico Inferiore. Italian for LHV (Lower Heating Value).
- **PCS:** Potere Calorifico Superiore. Italian for HHV (Higher Heating Value).
- **m H₂O:** Mass of the air produced (per each Kg of fuel) in the combustion in stoichiometric condition.
- **m Air:** Mass of the air needed for combustion in stoichiometric condition.
- **V g.d.:** Volume of dry smokes produced in the combustion.

Flue gas analysis according to Italian Law No. 10/1991 and subsequent modifications and supplements, Legislative Decree 192/2005 and the UNI 10389-1 standard

Preamble

It is Seitron intention, by means of this compact guide, to provide boiler installers/service technicians with a quick and easy way to understand whether a boiler conforms to the requirements of Italian Law no. 10 dated January 1991, and subsequent modifications and supplements, and Legislative Decree 192/2005.

The contents of this guide have been extremely simplified whereby they are not to be deemed at all comprehensive of the complex phenomenon of combustion.

Flue Gas Analysis: theory

During the combustion process taking place in a boiler, part of the heat evolved by the burner is transferred to the water or air to be heated. The quantity of heat available at the burner is called the input rating (Pf) and is usually declared by the boiler manufacturer. Part of this energy, known as the useful output (Pu), is used by the boiler. The remainder is lost to the flue gas in the stack and is known as Stack loss (Qs).

Thus we can say that: $Pf = Pu + Qs$

THE THERMAL EFFICIENCY OF COMBUSTION is given by:

$$\eta = 100 - Qs$$

According to the Italian Legislative Decree 192/2005 the MINIMUM thermal efficiency η should respect the values below:

For hot water generators:

Period of installation	Minimum efficiency %	Minimum with Pn < 35 kW
Before 29/10/1993	$84 + 2 * \log Pn - 2$	around 85 %
From 29/10/1993 to 31/12/1997	$84 + 2 * \log Pn$	around 87 %
From 01/01/1998 to 07/10/2005	Standard boilers $84 + 2 * \log Pn$	around 87 %
	Low temperature boilers $87.5 + 1.5 * \log Pn$	around 90 %
	Condensing boilers $91 + 1 * \log Pn$	around 92.5 %
After 08/10/2005	Condensing boilers $90 + 2 * \log Pn - 1$	around 92 %
	Other boilers $88 + 2 * \log Pn - 1$	around 90 %

For hot water generators:

Period of installation	Minimum efficiency %	Minimum with Pn < 35 kW
Before 29/10/1993	$83 + 2 * \log Pn - 6$	around 80 %
After 29/10/1993	$84 + 2 * \log Pn - 3$	around 83 %

Stack loss is calculated by applying a simple formula which relates it to other easily measurable parameters:

$$Q_s = \left(\frac{A_2}{CO_2} + B \right) (T_f - T_a)$$

Where: A₂, B = factor that depends on the fuel used
 T_f = flue gas temperature
 T_a = combustion air temperature
 CO₂ = % carbon dioxide in the flue gas

Thus in order to calculate the stack loss and hence the thermal efficiency of a plant, one must measure the two temperatures (flue gas and air) and the level of carbon dioxide contained in the flue gas (% CO₂). These operations are performed automatically by the flue gas analyzer during testing.

Let's take a look at the gases produced by combustion that need to be kept under control:

CO₂: CARBON DIOXIDE

The maximum CO₂ values that can be obtained from perfect combustion (theoretical) for the different types of fuels are:

Fuel	% max CO ₂
Methane	11,7
Propane	13,9
LPG	13,9
Butane	13,9
Diesel oil	15,1
Fuel oil	15,7

In truth, the percentage of CO₂ that can be detected during analysis will always be lower than these limit values.

CO: CARBON MONOXIDE

Carbon monoxide (CO) is usually produced by bad combustion that is weak in oxygen: since CO is a highly dangerous gas (it is fatal for man even in very low concentrations: exposure to 400 ppm for 3 hours is already fatal), standard UNI 10389-1 has established a limit value beyond which the test results of the boiler plant are deemed unsatisfactory. The percentage of gas considered by the standards, however, is not the value measured directly in the flue gas, which is "diluted" with other combustion products, but is the value referred to the volume of flue gas generated by perfect combustion, that is, where the oxygen is zero.

This limit is:

CO (referenced to 0% O₂) = 1000 ppm = 0.1%

Instructions for accurate testing

In order to achieve a certain degree of accuracy when conducting flue gas analysis, the following should be respected:

- the boiler being checked should be running in steady state conditions.
- the flue gas analyzer should be switched on at least 3 minutes before testing (time to auto-calibrate) with the probe located in fresh air.
- the point in which the probe is inserted for analysis has to be at a distance of approximately twice the stack diameter or, alternatively, as directed by the boiler manufacturer.
- the water trap should be completely empty and positioned vertically.
- before switching off the instrument, extract the probe and wait at least 3 minutes (the CO value has to drop below 10 ppm).
- Before returning the instrument to its place, clean the water trap and relative hose; if water is present in the hose clean the latter by blowing inside.

Optional measures list:

MEASURE	DEFINITION
λ, n	Air index (defined as λ , sometimes also indicated as n).
e	Air excess. Expressed as a percentage according to the formula in the appendix B, is the ratio between the volume of air actually entering the combustion chamber and the one theoretically needed.
ΔT	Differential temperature: It is the difference between the smoke temperature and the air combustion temperature.
Q_s (LHV)	Stack losses in relation to the Lower Heating Value: It is the percentage of dissipated heat through the stack referred to the lower heating value (LHV)
Q_s (HHV)	Stack losses in relation to the Higher Heating Value: It is the percentage of dissipated heat through the stack referred to the higher heating value (HHV)
η_s (LHV)	Sensible efficiency in relation to the Lower Heating Value: It is the burner efficiency calculated according to the UNI 10389-1 standard, as the ratio between conventional heating power and the burner heating power. Among the combustion losses, only the sensible heat lost with flue gasses is taken into account, thus neglecting the radiation losses and incomplete combustion losses. This value is referred to the Lower Heating Value (LHV) of the fuel and cannot exceed 100%. The sensible efficiency value is to be compared against minimum efficiency stated for the heating system performances.
η_s (HHV)	Sensible efficiency in relation to the Higher Heating Value: It is the burner efficiency calculated as the ratio between conventional heating power and the burner heating power. Among the combustion losses, only the sensible heat lost with flue gasses is taken into account, thus neglecting the radiation losses and incomplete combustion losses. This value is referred to the Higher Heating Value (HHV) of the fuel and cannot exceed 100%. The sensible efficiency value is to be compared against minimum efficiency stated for the heating system performances.
η_c (LHV)	Condensation efficiency in relation to the Lower Heating Value: Efficiency deriving from the condensation of water vapour contained in flue gases, calculated according to the UNI 10389-1 standard, and it is referred to the LHV.
η_c (HHV)	Condensation efficiency in relation to the Higher Heating Value: Efficiency deriving from the condensation of water vapour contained in flue gases referred to the HHV.
η_t (LHV) $\eta_t = \eta_s + \eta_c$	Total efficiency in relation to the Lower Heating Value: Total efficiency. It is the sum of sensible efficiency and condensation efficiency. It is referred to LHV (Lower Heating Value) and can exceed 100%.

MEASURE	DEFINITION
ηt (HHV)	Total efficiency in relation to the Higher Heating Value: Total efficiency. It is the sum of sensible efficiency and condensation efficiency. It is referred to HHV (Higher Heating Value) and can not exceed 100%.
Qt (HHV)	Total stack losses: It is the total heat percentage dissipated through the stack.
NOx	Measure of nitrogen oxides quantity; the measurement unit can be set in the special menu.
NOx ppm *	Measure of nitrogen oxides quantity; the measurement unit can not be set but it is fixed in ppm.
NOx (rif. O2)	Measure of nitrogen oxides quantity referring to O2; the measurement unit can be set in the special menu.
NOx (rif. O2) ppm *	Measure of nitrogen oxides quantity referring to O2; the measurement unit can not be set but it is fixed in ppm.
PI	Poison Index (CO/CO2 ratio): It is defined as the ratio between CO and CO2 useful to determine whether the system needs maintenance.
CO	CO quantity measurement. Measurement units: ppm - mg/m ³ - mg/kWh - g/GJ - g/m ³ - mg/kWh - % - ng/J
CO (RIF)	CO quantity measurement with O2 reference. Measurement units: ppm - mg/m ³ - mg/kWh - g/GJ - g/m ³ - g/kWh - % - ng/J
T dew	Flue water condensation temperature (Dew point). This value is calculated.

* : Valid for Piemonte region only (Italy only).



OTHER THAN THE MEASUREMENT LIST ABOVE, IT IS POSSIBLE TO VISUALIZE THE MEASURE OF THE DETECTED GAS ALSO IN PPM, DEPENDING ON THE KIND OF MEASUREMENT CELL IN THE INSTRUMENT. IF IT IS NECESSARY TO MEASURE THE VALUE OF GAS WITH TWO DIFFERENT MEASUREMENT UNITS, SELECT IN THE MEASUREMENTS LIST THE DESIRED GAS IN PPM AND CHANGE THE MEASUREMENT UNIT FOR THE SAME GAS IN THE "CONFIGURATION->ANALYSIS->MEASUREMENT UNIT" SCREEN. NOW THE INSTRUMENT ACQUIRES THE MEASURE WITH TWO DIFFERENT UNITS (PPM AND THE ONE PREVIOUSLY SET)

WARRANTY CERTIFICATE

WARRANTY

Chemist 900 combustion analyzer is guaranteed for 24 months from the date of delivery note, electronic parts, measurement cells and printer included.

Seitron undertakes to repair or replace, free of charge, those parts that, in its opinion, are found to be faulty during the warranty period. The products which are found defective during the above mentioned periods of time have to be delivered to Seitron Laboratories carriage paid. The following cases are not covered by this warranty: accidental breakage due to transport, inappropriate use or use that does not comply with the indications in the product's use and maintenance manual.

Any mistreatment, repairs and modifications to the product not explicitly authorized by Seitron shall invalidate the present warranty.

IMPORTANT

For the product to be repaired under Warranty, please send a copy of this Certificate along with the instrument to be repaired, together with a brief explanation of the fault observed.

Space reserved for user

Name: _____

Company: _____

User's notes:

Date: _____

S.N.:



Via del Commercio, 9/11 - 36065 - MUSSOLENTE (VI) - Tel. (+39).0424.567842 - Fax. (+39).0424.567849



SEITRON S.p.A. a socio unico
Via del Commercio, 9/11 36065 - Mussolente (VI) ITALY
+39 0424 567 842 - info@seitron.it - www.seitron.com