

Instruction Manual

Human- Vibration Analyzer VM31

(Valid from version xxx.019)



Manfred Weber

Metra Mess- und Frequenztechnik in Radebeul e.K.

Meissner Str. 58 - D-01445 Radebeul

Tel. +49-351 836 2191 Fax +49-351 836 2940

Email: Info@MMF.de Internet: www.MMF.de

Published by:

Manfred Weber

Metra Mess- und Frequenztechnik in Radebeul e.K.

Meißner Str. 58

D-01445 Radebeul

Tel. +49-351-836 2191

Fax +49-351-836 2940

Email Info@MMF.de

Internet www.MMF.de

Note: The latest version of this manual can be found at http://www.mmf.de/product_literature.htm

Specification subject to change.

© 2014 Manfred Weber Metra Mess- und Frequenztechnik in Radebeul e.K.

Full or partial reproduction subject to prior written approval.

Contents

1. Purpose.....	2
2. The Device at a Glance.....	2
3. Fundamentals of Human Vibration Measurement.....	3
3.1. Introduction.....	3
3.2. EU Occupational Health Directive 2002/44/EC.....	4
4. Human Vibration Measurement with the VM31.....	7
4.1. Batteries.....	7
4.2. Switching on and Connecting the Sensor.....	8
4.3. Hand-Arm Measurement with the VM31.....	9
4.3.1. Measuring Points for Hand-Arm Vibration.....	9
4.3.2. VM31 Settings.....	10
4.4. Whole-Body Measurement with the VM31.....	12
4.4.1. Measuring Points for Whole-Body Vibration.....	12
4.4.2. VM31 Settings.....	14
4.4.2.1. Whole-Body Measurement with RMS Values.....	14
4.4.2.2. Whole-Body Vibration Measurement with VDV Values.....	18
4.4.2.3. Seat Effective Amplitude Transmissibility (SEAT).....	19
5. General Vibration Measurement.....	19
6. Data Logger.....	22
7. Frequency Analysis.....	23
8. Data Memory.....	24
8.1. Measurement Data Memory.....	24
8.2. Logger Data Memory.....	24
8.3. FFT Data Memory.....	25
9. Keypad Lock.....	25
10. Device Settings.....	25
10.1. Sensor Calibration.....	25
10.2. Time and Date.....	25
10.3. Shut-off Timer.....	26
10.4. Battery Type.....	26
10.5. Display Brightness.....	26
10.6. Menu Language.....	26
10.7. Default Settings.....	27
11. Reset Key.....	27
12. Connection to a PC.....	27
13. Data Transfer to a PC.....	28
13.1. Opening the Excel File vm31.xlsm.....	28
13.2. Data Import to Excel.....	29
13.3. Calculation of Vibration Exposure A(8) and VDV(8).....	29
13.4. FFT Data Import to Excel.....	30
14. Firmware Update.....	31
15. Calibration.....	33
16. Technical Data.....	34

Appendix: Warranty
Declaration of CE Conformity

Thank you for choosing a Metra Vibration Measurement device!

1. Purpose

The VM31 has been developed, particularly, for the measurement and analysis of human vibration. Other fields of application include machine condition monitoring, building vibration measurement and quality control.

In combination with a triaxial accelerometer, hand-arm and whole-body vibrations can be measured in compliance with ISO 5349, ISO 2631 and the EU Directive 2002/44/EC. A fourth measuring channel can be used, for example, for SEAT measurements (seat effective acceleration transmissibility).

The VM31 meets the requirements for human vibration meters in compliance with ISO 8041. In the development of the VM31 value was placed on simple operation and compact design.

In addition to its application as human vibration meter the VM31 can also measure machine vibration according to ISO 10816-1/2/3/5/6/7. Measuring ranges for acceleration, velocity and displacement are available.

2. The Device at a Glance



Figure 1: Controls, connectors and display

3. Fundamentals of Human Vibration Measurement

3.1. Introduction

Vibrations affecting the human body are called human vibration. The main purpose of measuring human vibration is the prevention of health risks and the evaluation of comfort, for example in vehicles.

Two categories are distinguished:

- **Hand-Arm Vibrations**, which are induced via the hands into the body. They may cause, for example, circulatory disorder, bone, joint or muscle diseases.
- **Whole-Body Vibrations**, acting via the buttocks, the back and the feet of a sitting person, the feet of a standing person or the back and the head of a recumbent person. Such vibrations may cause backache or damage to the spinal column.

Both types of human vibration measurement are described in international standards:

- **ISO 5349** - Measurement and evaluation of human exposure to hand-transmitted vibration
- **ISO/TR 18570** – Measurement and evaluation of human exposure to hand-transmitted vibration – Supplementary method for assessing risk of vascular disorders
- **ISO 2631** - Evaluation of human exposure to whole-body vibration (also ASA/ANSI S3.18)
- **ISO 8041** - Human response to vibration. Measuring Instrumentation
- **ISO 8662** - Hand-held portable power tools - Measurement of vibrations at the handle
- **ISO 20283-5** - Guidelines for the measurement, reporting and evaluation of vibration with regard to habitability on passenger and merchant ships
- **ISO 10056** - Measurement and analysis of whole-body vibration to which passengers and crew are exposed in railway vehicles
- **ISO 10326** - Laboratory method for evaluating vehicle seat vibration
- **ISO 28927** - Hand-held portable power tools - Test methods for evaluation of vibration emission

Practical advice for measurement and evaluation of human vibration can be found in **VDI 2057**.

The subject of human vibration has gained particular importance in Europe since the directive **2002/44/EC** came into effect. It specifies the duties of employers with regard to workers protection.

3.2. EU Occupational Health Directive 2002/44/EC

The following text is an abstract of Directive 2002/44/EC of the European Parliament and of the Council dated June 25, 2002. The complete text can be downloaded from <http://eur-lex.europa.eu/>

The directive specifies minimum requirements for the protection of workers from the risks arising from vibrations. Manufacturers of machines and employers should make adjustments regarding risks related to exposure to vibration.

The directive lays down the following limit values:

	Hand-Arm, RMS	Whole-Body, RMS	Whole-Body, VDV
Exposure action value	2.5 m/s ²	0.5 m/s ²	9.1 m/s ^{1.75}
Exposure limit	5 m/s ²	1.15 m/s ²	21 m/s ^{1.75}

Table 1: Limits to EU directive 2002/44/EC

Once the **exposure action value** is exceeded, the employer shall establish and implement a program of technical and organizational measures intended to reduce to a minimum exposure to mechanical vibration, taking into account in particular:

- Other working methods that require less exposure to mechanical vibration
- Appropriate work equipment of ergonomic design, producing the least possible vibration
- Provision of auxiliary equipment that reduces the risk of injuries, such as protective gloves or special seats
- Appropriate maintenance programs for work equipment
- Design and layout of workplaces
- Adequate information and training to instruct workers to use work equipment correctly and safely
- Limitation of the duration and intensity of the exposure
- Work schedules with adequate rest periods
- Provision of clothing to protect workers from cold and damp

In any event, workers shall not be exposed above the **exposure limit value**. If this should be the case, the employer shall take immediate action to reduce exposure below the exposure limit value.

The methods used may include sampling, which must be representative of the personal exposure of a worker to the mechanical vibration in question.

The assessment of the level of exposure to vibration is based on the calculation of **daily exposure A(8)** expressed as equivalent continuous acceleration over an eight-hour work period. For the determination of A(8) it is not necessary to measure over eight hours. It is sufficient to make short-term measurements during representative work steps. The results are normalized to eight hours. Daily exposure is calculated as follows:

$$A(8) = a_{we} \sqrt{\frac{T_e}{T_0}} \quad \text{Equation 1}$$

where

A(8) is the daily exposure

a_{we} is the energy equivalent mean value of the frequency weighted acceleration during exposure, which means

- For **Hand-Arm Vibration** the X/Y/Z vector sum of Wh frequency-weighted RMS values (Equation 2)

$$a_w = \sqrt{a_{wx}^2 + a_{wy}^2 + a_{wz}^2} \quad \text{Equation 2}$$

- For **Whole-Body Vibration** the highest of the three RMS values

a_{wx} , a_{wy} and a_{wz} with the following frequency and magnitude weightings:

- X and Y with weighting filter Wd and weighting factor 1.4

- Z with weighting filter Wk and weighting factor 1.0

T_e is the total duration of exposure during one work day

T_0 is the reference duration of 8 hours

Daily exposure may consist of several partial exposures with different vibration magnitudes. This can be the case if there are longer interruptions in the work process, if the work equipment or its way of use is changed. A partial exposure section should have a roughly constant magnitude and less than 10 % interruptions. Resulting daily exposure is calculated as follows:

Hand-Arm Vibration:

$$A(8) = \sqrt{\frac{1}{T_0} \sum_{i=1}^n a_{wi}^2 T_{ei}} \quad \text{Equation 3}$$

where

A(8) is the daily exposure

a_{wi} is the energy equivalent mean value of the Wh frequency weighted acceleration of partial exposure section i

n is the number of partial exposure sections

T_{ei} is the duration of exposure i

T_0 is the reference duration of 8 hours

Whole-Body Vibration:

Separate daily exposures need to be calculated for X/Y/Z. The highest value is used for the evaluation, i.e. compared with the limits of Table 1.

$$A_x(8) = \sqrt{\frac{1}{T_0} \sum_{i=1}^n a_{wxi}^2 T_{ei}} \quad \text{Equation 4}$$

$$A_y(8) = \sqrt{\frac{1}{T_0} \sum_{i=1}^n a_{wyi}^2 T_{ei}} \quad \text{Equation 5}$$

$$A_z(8) = \sqrt{\frac{1}{T_0} \sum_{i=1}^n a_{wzi}^2 T_{ei}} \quad \text{Equation 6}$$

where

$A_{x/y/z}(8)$ are the daily exposures of directions X/Y/Z

$a_{wx/y/zi}$ are the energy equivalent mean values of the frequency weighted accelerations in the directions X/Y/Z during partial exposure section i with the following frequency and magnitude weightings:

- X and Y with weighting filter Wd and weighting factor 1.4
- Z with weighting filter Wk and weighting factor 1.0

n is the number of partial exposure sections

T_{ei} is the duration of exposure i

T_0 is the reference duration of 8 hours

The calculations shown above are based on RMS values. An alternative method uses fourth-power mean values called **Vibration Dose Value (VDV)** with the measuring unit $m/s^{1.75}$. Table 1 also includes VDV based limit values.

VDV based daily exposure $VDV(8)$ is calculated:

$$VDV(8) = VDV \cdot \sqrt[4]{\frac{T_{exp}}{T_{meas}}} \quad \text{Equation 7}$$

where

$VDV(8)$ is the daily exposure value

VDV is the frequency-weighted vibration dose value

T_{exp} is the duration of exposure

T_{meas} is the duration of VDV measurement

Daily exposure may consist again of several partial exposure sections. Separate daily exposure values are to be calculated for X/Y/Z. The highest one is compared with the limits of Table 1 for evaluation.

$$VDV_x(8) = \sqrt[4]{\sum_{i=1}^n VDV_{xi}^4 \cdot \frac{T_{iexp}}{T_{imeas}}} \quad \text{Equation 8}$$

$$VDV_y(8) = \sqrt[4]{\sum_{i=1}^n VDV_{yi}^4 \cdot \frac{T_{iexp}}{T_{imeas}}} \quad \text{Equation 9}$$

$$VDV_z(8) = \sqrt[4]{\sum_{i=1}^n VDV_{zi}^4 \cdot \frac{T_{iexp}}{T_{imeas}}} \quad \text{Equation 10}$$

where

$VDV_{x/y/z}(8)$ are the daily exposures of directions X/Y/Z

$VDV_{x/y/zi}$ are the frequency-weighted vibration dose values of directions X/Y/Z during exposure section i

T_{exp} is the duration of exposure section i

T_{meas} is the duration of VDV measurement during exposure section i

Model VM31 measures Hand-Arm and Whole-Body vibration, the latter as RMS or VDV values. For the calculation of daily exposure an Excel sheet with a data import function is provided.

4. Human Vibration Measurement with the VM31

4.1. Batteries

The VM31 is powered from three standard alkaline batteries size AAA (LR03). Alternatively rechargeable NiMH batteries of type HR03 can be inserted. Precise operation is guaranteed until the batteries are almost completely discharged.

Please note that date and time need to be adjusted after replacing the batteries. All other settings, including saved measurements, remain stored after removing the batteries.

To insert the batteries, remove the two screws from the back cover of the device and open the battery compartment (Figure 2). When inserting the batteries, please ensure that their polarity is correct, (see the engraved markings inside the compartment).



Figure 2: Batteries

Important:

- Always use three batteries of the same type and same date of manufacture.
- Remove old batteries from the device, and take out the batteries if the device will not be used for a long period of time. Otherwise leaking battery acid may cause severe damage to the device.



Please use your local collection point to dispose of batteries.

Batteries do not belong to the household waste.

A battery indicator can be found in the upper left corner of the display. A green filled battery symbol indicates a fully charged battery. When the symbol becomes red only a small portion of power remains and the unit will switch-off soon. Please also read section 10.4.

If the VM31 is connected to a USB interface, it will be powered via USB to save the batteries. In this case “Extern” is shown instead of the battery symbol.

4.2. Switching on and Connecting the Sensor

Switch on the VM31 by pressing the ON/OFF key. The unit can be switched off again by pressing and holding the ON/OFF key for one second.

If the sensor has not yet been connected, plug the sensor cable into the right connector. The VM31 will start TEDS¹ detection each time it is switched on or a sensor is connected. It supports IEEE 1451.4 TEDS template no. 25 (with or without transfer function). The sensitivities of X/Y/Z and channel A are displayed for some seconds (Figure 3). For each channel also the user text of TEDS (ID) is displayed.

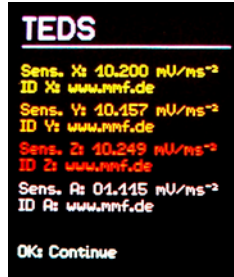

Figure 3:
TEDS detection



Figure 4: Seat pad accelerometer KB103SVD



Figure 5:
Hand-Arm accelerometer KS903.10

The sensors KB103SVD and KS903.10 supplied by Metra feature TEDS.

Should a connected sensor not have TEDS or an incompatible TEDS version, the VM31 will open a menu for entering the sensitivities manually (see section 10.1).

The sensitivities entered remain stored as long as the sensor is connected, even if the batteries are removed.

The warning “SENSOR!” indicates a missing or defective sensor or a broken sensor cable. Sensor condition is detected by means of the bias voltage at the sensor output:

- < 0.7 V: short circuit
- 0,7 – 14 V: normal
- >14 V: open, e.g. broken cable

Please note that settling time after connecting a sensor is about 1 minute.

The VM31 is suitable for connecting any low power IEPE accelerometers which can be operated with a 1 mA supply current. The internal compliance voltage of the current sources is 18 VDC.

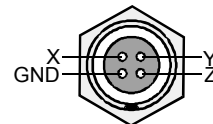

Figure 6:
Sensor socket
(view from outside)

¹ TEDS = Transducer Electronic Data Sheet

Figure 6 shows the contact arrangement of the 4 pin female sensor connector of type *Binder 711*.

4.3. Hand-Arm Measurement with the VM31

This section will give you basic instructions for the measurement and evaluation of hand-arm vibrations based on the standard ISO 5349 and the guideline VDI 2057, Part 2. Please consult the original documents for detailed explanations.

4.3.1. Measuring Points for Hand-Arm Vibration

The sensors should be attached as close as possible to the gripping points of the hand, however, they must not interfere with the work process. Measurement should be performed with the same hand pressure force as used under normal operating conditions.

Since most machine tool handles do not provide surfaces for the adhesive or screw attachment of sensors, Metra offers some mounting accessories for curved surfaces.

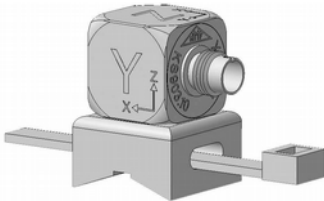

Figure 7: Handle adapter 141

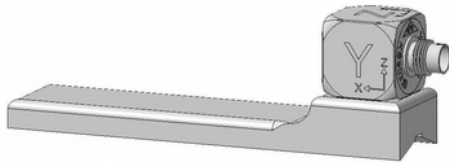

Figure 8: Hand-held adapter 143

The adapter model 141 is attached with a plastic cable strap. Model 143 is pressed onto the handle by the hand.

Close contact between the sensor and the machine is of great importance. Any motion of the sensor would distort the measurement.

Figure 9 shows the axis directions for attaching the sensor to the handle. For cylindrical handles the Y direction points in the direction of the handle axis. The Z axis is approximately the extension of the third metacarpal bone.

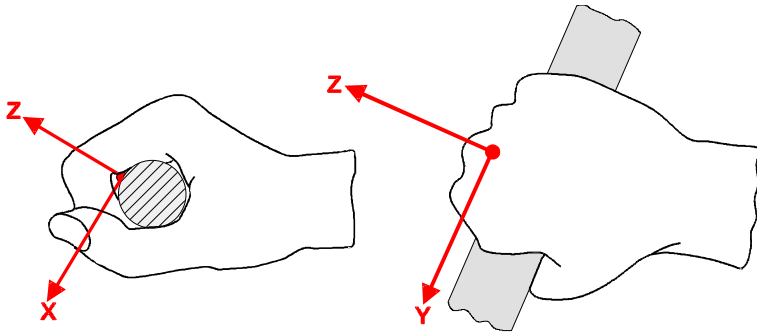

Figure 9: Coordinate system of the hand (from ISO 5349-1)

4.3.2. VM31 Settings

For the evaluation of hand-arm vibration it is recommended to measure both the interval RMS values of X/Y/Z and their vector sum a_w . The VM31 measures these four values simultaneously. In addition it shows the maximum running RMS (Maximum Transient Vibration Value, MTVV) which may indicate the presence of shock vibration.

The frequency weighting for hand-arm vibration is W_h . Figure 11 shows the filter of the VM31 and the tolerance bands to ISO 5349.

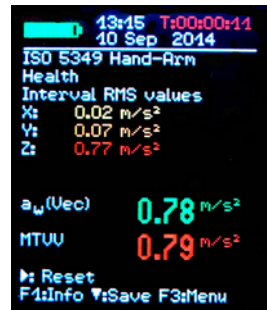

Figure 10:
Hand-arm measurement

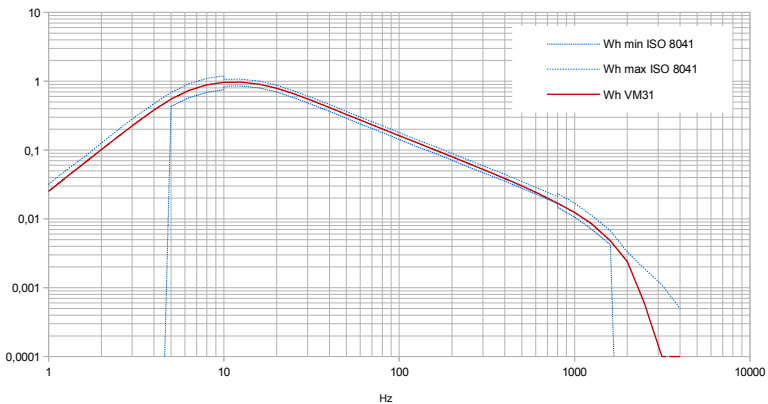

Figure 11: Hand-arm weighting filter W_h to ISO 8041

The VM31 supports in addition measurements with frequency weighting W_p according to ISO/TR 18570 (Figure 12). It was developed for assessing the risk of vascular diseases (vibration white finger). However, there are no mandatory limit values yet for this type of measurement.

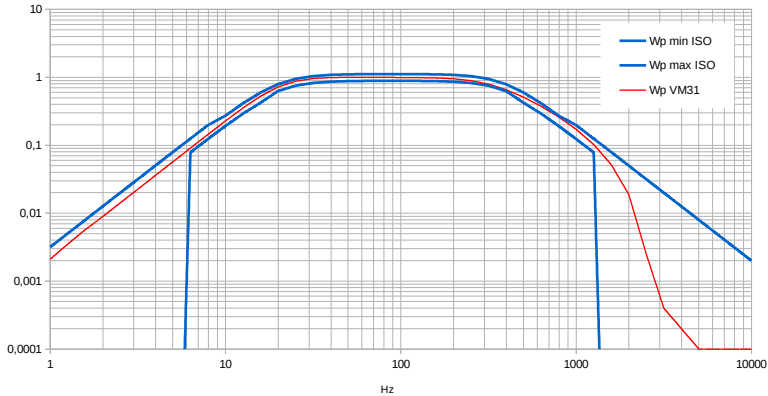

Figure 12: Hand-Arm-weighting filter W_p to ISO/TR 18570

Press the F3 key to open the main menu and select “Human vibration” / “Hand-Arm ISO 5349”/„Health“. After returning to the measurement screen (Figure 10) you can check the settings by pressing F1.

Measurement can begin when the sensor and the worker's hands have been placed on the handle of the object carrying out the operation. To start the measurement press the key ► (Reset). This will result in the following:

- the RMS values of X/Y/Z, the vector sum a_w and MTVV reset to zero
- the measurement timer restarts.

Pressing Reset before a measurement is mandatory to establish defined start conditions.

The RMS values of X/Y/Z and the vector sum are averaged over the entire measuring time. That's why fluctuation becomes less the longer the measurement takes. After a while short shock pulses have almost no influence on the displayed results .

Recommended measuring time for hand-arm vibration is at least 30 seconds. The measuring timer in the upper right corner remains red until 30 second have elapsed.

“OVERLOAD” is indicated instead of the measuring values if the current magnitude is too high. Even if the overload condition was of short duration the measured interval RMS value may become invalid because of missing samples. An overload event during the entire averaging time is indicated by “OVL!” in the upper right corner after the date. This warning can be deleted by pressing the key ► (Reset).

After measurement you may save the results by pressing the key ▼. Measurement should be continued or finished immediately before pressing the key. Otherwise the measuring values will drop slowly. You will be asked to enter two lines of ten capital letters or numbers as a comment (Figure 13). Use the keys ◀▲▼▶ to select characters and to change the input position. Press F1 to change the input line. Measurement can be finished before entering the comment because the results have already been saved when pressing the key ▼.

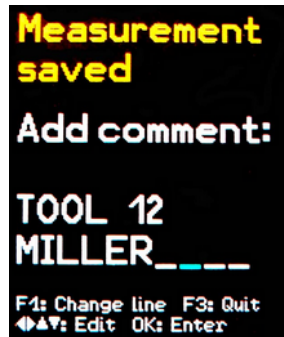

Figure 13: Comment

Measurements can only be saved if a sensor is detected at X/Y/Z and if there is no overload condition. In these cases the VM31 will display “Sensor error” or “Overload occurred” instead of saving in order to avoid invalid recordings. If an overload occurred since the last reset (“OVL!” in upper right corner) the instrument will show a warning “Overload occurred after last reset! Save anyway?”.

If you want to measure several partial exposures you may do further measurements (see section 3.2).

For the calculation of **vibration exposure A(8)** and to store results on a PC the Excel macro file vm31.xlsm is provided.

The fourth channel (A) of the VM31 is not active when hand-arm vibration is measured.

4.4. Whole-Body Measurement with the VM31

This section will give you basic instructions for the measurement and evaluation of whole-body vibrations based on the standard ISO 2631 and the guideline VDI 2057, Part 1. Please consult the original documents for detailed explanations.

The described method is suitable for all vibrations acting on the human body. It is not suited for vibration containing occasional shocks or for impacts such as car crashes. Vibrations transmitted via the hands are described separately in the previous section.

4.4.1. Measuring Points for Whole-Body Vibration

Whole-body vibration is usually measured with seat pad accelerometers. These are triaxial piezoelectric sensors built into a flat rubber pad, which adapt themselves to the interface between the vibration source and the test person (Figure 4).

The following measuring points are suitable:

- On the seat surface under a seated person
- On the back rest behind a seated person
- Under the feet of a seated person
- Under the feet of a standing person
- Under the pelvis of a recumbent person
- Under the head of a recumbent person

Figure 14 shows the coordinate systems for whole-body vibration to ISO 2631. As can be seen from the drawing, the Z axis always points in the direction of the spinal

column. The vibration sensor has to be placed accordingly. A special case is measurement at the backrest (see notice below Table 2 on page 13).

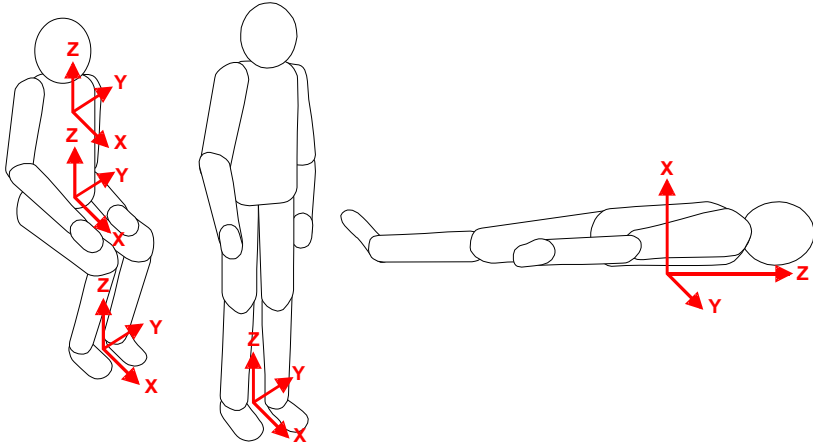

Figure 14: Coordinate systems for whole-body vibration to ISO 2631

Table 2 shows the weighting filters and factors to be used for different postures and positions.

Whole-Body Health Evaluation				
<i>Posture</i>	<i>Position</i>	<i>Direction</i>	<i>Frequency weighting</i>	<i>Weighting factor (k)</i>
sitting	seat surface	X / Y	W_d	1.4
		Z	W_k	1
Whole-Body Comfort Evaluation				
sitting	seat surface	X / Y	W_d	1
		Z	W_k	1
	feet platform	X / Y	W_k	0.25
		Z		0.4
backrest		X*	W_c	0.8
		Y	W_d	0.5
		Z*	W_d	0.4
standing	feet platform	X / Y	W_d	1
		Z	W_k	1
recumbent	under pelvis	X (vertical)	W_k	1
		Y / Z (horizontal)	W_d	1
	under head	X (vertical)	W_j	1
In railway vehicles:				
standing	feet platform	X / Y / Z	W_b	1
sitting	seat/backrest/feet			
recumbent	support, surface, pelvis/head			
In buildings:				
undefined	in buildings	X / Y / Z	W_m	1

Table 2: Weighting filters and factors for whole-body vibration

* Please note that the Z axis points along the backbone for all measurements. For measurements at the backrest with a seat pad accelerometer the sensor will always be in a vertical position with Z perpendicularly to the backbone. However, to compensate this the VM31 automatically swaps the X and Z axis for backrest measurement.

4.4.2. VM31 Settings

4.4.2.1. Whole-Body Measurement with RMS Values

For the evaluation of hand-arm vibration it is recommended to measure both the interval RMS values of X/Y/Z and their vector sum a_w . The VM31 measures these four values simultaneously. In addition it shows the maximum running RMS (Maximum Transient Vibration Value, MTVV) which may indicate the presence of shock vibration. MTVV is not always the maximum value of the three single RMS values of X/Y/Z since these are multiplied with weighting factors (see table 2) which is not the case for MTVV.

The following section explains the measurement of whole-body vibration in terms of health risks. Health evaluation is done with weighting filter W_d for X/Y and W_k for Z and with weighting factors 1.4 for X/Y and 1.0 for Z. Figures 16 and 17 show the frequency response curves of the filters W_d and W_k in VM31 and the tolerance bands in compliance with ISO 8041.

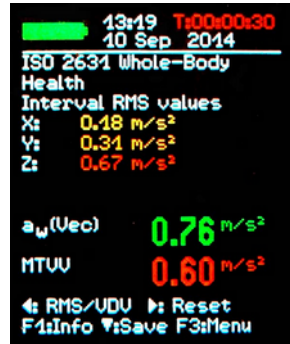

Figure 15: Whole-body measurement

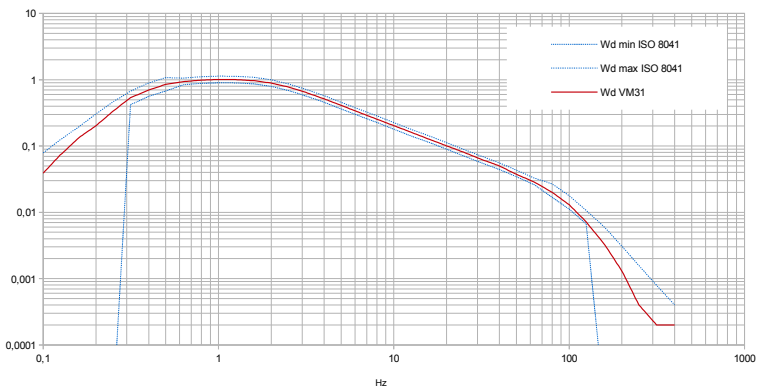

Figure 16: Whole-body weighting filter W_d

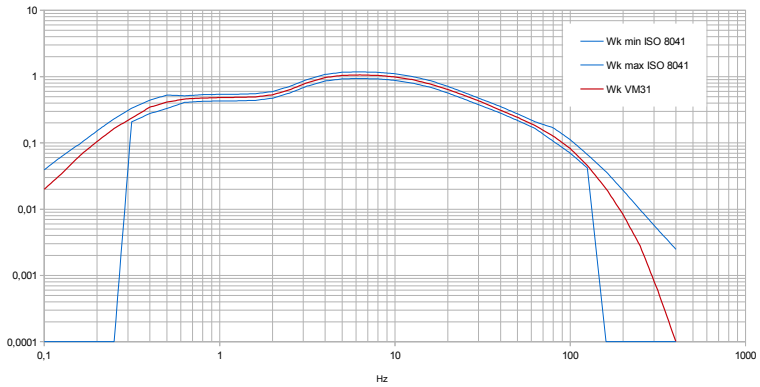

Figure 17: Whole-body weighting filter W_k

In addition to health evaluation the VM31 also supports measurements regarding comfort. This type of measurement uses other postures, sensor positions and different frequency weightings but the general procedure is the same.

Figures 18 to 21 show the frequency response curves of the weighting filters for comfort measurements.

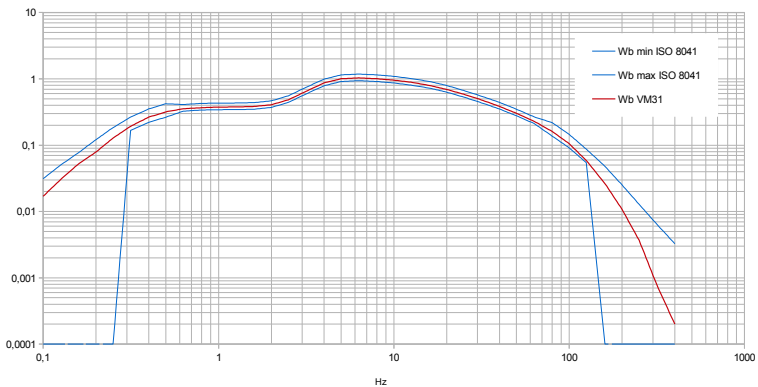

Figure 18: Whole-body weighting filter W_b for passenger trains

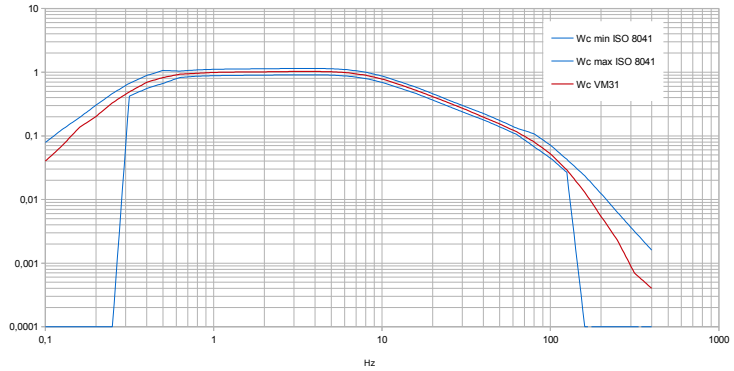

Figure 19: Whole-body weighting filter W_c for the backrest of seats

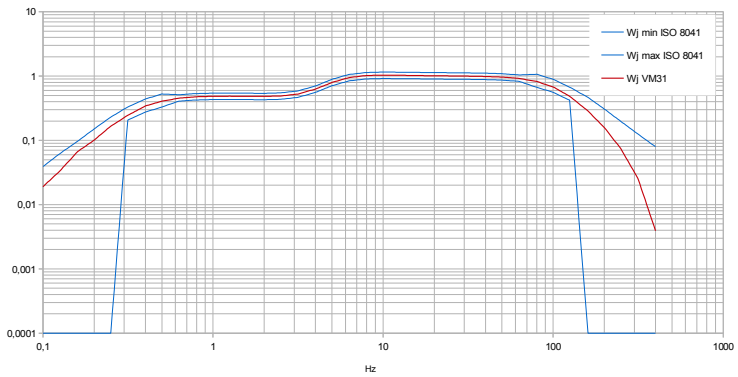

Figure 20: Whole-body weighting filter W_j for the head of recumbent persons

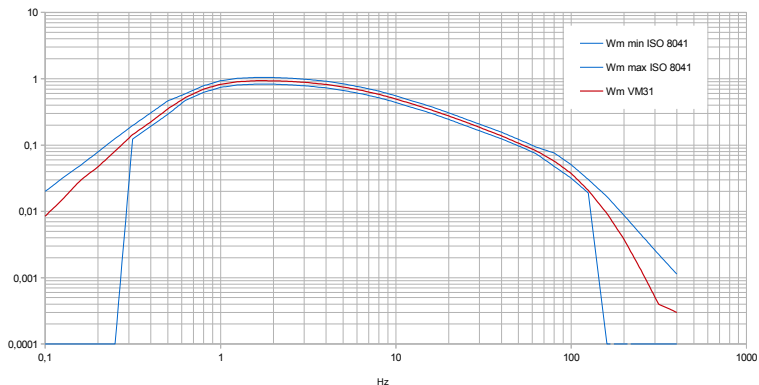

Figure 21: Whole-body weighting filter W_m for persons in buildings

To start whole-body vibration measurement for the assessment of health risks open the main menu by pressing F3, and select “Measuring mode” / “Human vibration” / “Whole-body ISO 2631” / “Health”. From this menu you will return to the measuring screen (Figure 15). You may press F1 to check your settings.

According to ISO 2631-1 there are two evaluation methods for whole body vibration: basic evaluation and additional evaluation. Basic evaluation is performed by interval RMS measurement. Additional evaluation can be the running RMS method (MTVV) or the fourth power vibration dose method (VDV) whereupon the latter is more common. One of the two additional evaluation methods should be applied for occasional shocks or transient vibration since the basic evaluation methods may underestimate their effects. A measure for the shock content of vibration is the crest factor, i.e. the ratio of peak and RMS. If the crest factor exceeds 9 the additional evaluation method should be applied.

If the worker being tested is sitting in the right position and vibration exposure has started measurement can begin.

Select crest factor mode by pressing the ◀ key and start crest factor measurement by the ▶ key (Reset). This will

- reset the RMS values of X/Y/Z, the vector sum a_w and MTVV to zero
- restart the measurement timer.

Always press Reset before a measurement to establish the defined start conditions.

If the displayed crest factors X/Y/Z are below 9, switch to Interval RMS mode by pressing the ◀ key. At crest factors above 9 you should measure in addition vibration dose as shown in the next section.

Interval RMS values and crest factors are calculated based on the elapsed measuring time since the last pressing of the key ▶ (Reset). This means that the fluctuation of the displayed values becomes lower the longer the measurement lasts. Single peaks will have less influence than at the beginning. Relevant for evaluation is only the value at the end of measurement. The recommended measuring time for whole-body

vibration is at least 2 minutes. To alert you, the timer in the upper right corner remains red until 2 minutes have elapsed.

The displayed interval RMS for X/Y/Z and vibration total values a_w include the weighting factors (k) according to table 2. The weighting factors are set to 1 for maximum RMS (MTVV) and vibration dose value (VDV).

“OVERLOAD” is indicated instead of the measuring values if the current magnitude is too high. Even if the overload condition was of short duration the measured interval RMS value may become invalid because of missing samples. An overload event during the entire averaging time is indicated by “OVL!” in the upper right corner after the date. This warning can be deleted by pressing the key ► (Reset).

After measurement you may save the results by pressing the key ▼. Measurement should be either continued or finished immediately before pressing the key. Otherwise the measuring values will drop slowly. You will be asked to enter two lines of ten capital letters or numbers as a comment (Figure 13, page 12). Use the keys ◀▲▼▶ to select characters and to change the input position. Press F1 to change the input line. Measurement can be finished before entering a comment because the results will have already been saved by pressing the key ▼.

Measurements can only be saved if a sensor is detected at X/Y/Z and if there is no overload condition. In these cases the VM31 will display “Sensor error” or “Overload occurred” instead of saving in order to avoid invalid recordings. If an overload occurred since the last reset (“OVL!” in upper right corner) the instrument will show a warning “Overload occurred after last reset! Save anyway?”.

If you want to measure several partial exposures you may now do further measurements (see section 3.2).

For the calculation of **vibration exposure A(8)** and to store results on a PC the Excel macro file vm31.xlsm is provided (see section 13.3).

4.4.2.2. Whole-Body Vibration Measurement with VDV Values

The VM31 also allows whole-body vibration to be measured as vibration dose values (VDV). These are integrated fourth power values. VDV is more sensitive to peaks. The measuring unit of VDV is $m/s^{1.75}$.

$$VDV = \sqrt[4]{\int_0^T a_w^4(t) dt}$$

Equation 11

Press the key ◀ to switch from RMS to VDV (Figure 22).

The same weighting filters as for RMS measurement are used. You may press F1 to check your settings.

The device displays VDV values for the directions X/Y/Z. In addition the highest of the three axis values (Max. VDV) and the highest VDV since the last reset (Max. abs.) are displayed.

VDV measurements need to be started by pressing the key ► (Reset).

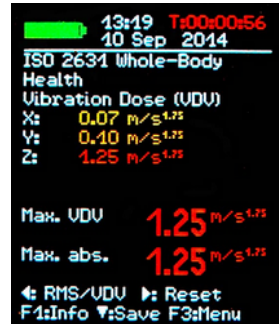

Figure 22: VDV mode

Measurements can be saved by pressing the key ▼ (see page 18).

For vibration exposure VDV(8) calculation the duration of VDV measurement should be noted (see section 3.2).

The Excel file vm31.xlsm also allows the calculation of **vibration exposure VDV(8)** (see section 13.3).

4.4.2.3. Seat Effective Amplitude Transmissibility (SEAT)



Figure 23: SEAT measurement at a drivers seat

The Seat Effective Amplitude Transmissibility (SEAT) value is the ratio of the vibration experienced on top of the seat and the vibration that one would be exposed to when sitting directly on the vibrating floor. Both vibration magnitudes are measured in the vertical direction (Z) only. SEAT values are widely used to determine the vibration isolation efficiency of a seat.

The fourth channel (A) of the VM31 in combination with a uniaxial accelerometer can be used to determine SEAT values. Metra recommends the TEDS accelerometer KS78.100 for this purpose. It is connected via a sensor cable VM31-A to the left socket (see 1). The fourth channel is named “A” on the display. The sensitivity of the KS78.100 will be automatically detected. With a non-TEDS sensor it needs to be entered manually (see section 4.2).

Select “Whole-body ISO 2631” / “Unweighted” for channels X/Y/Z. Channel A does not have frequency weightings. Its frequency range (-3 dB) is 0.8 to 250 Hz. The RMS or VDV of channel A is displayed below channels X/Y/Z (Figure 24).

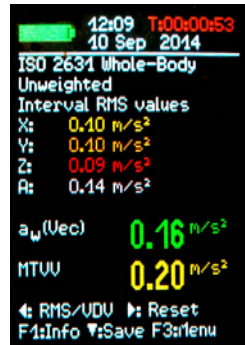

Figure 24: SEAT measurement with channel A

5. General Vibration Measurement

In addition to human vibration the VM31 measures:

- Vibration acceleration from 0.2 to 1500 Hz and 1 to 1000 Hz,
- Vibration velocity from 1 to 100 Hz, 2 to 1000 Hz and 10 to 1000 Hz (for machine vibration to ISO 10816),
- Vibration displacement from 5 to 200 Hz.

Press F3 to open the menu, select “Measuring mode” and use the keys ▲ ▼ to select the vibration range.

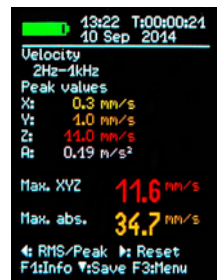

Figure 25: 4 channels and combined values

You can switch the measuring screen from RMS to peak display by pressing the key ◀. Please note that the RMS and peak values in the general vibration ranges are measured over the last display cycle (not over a long period). A display cycle can be between 1 and 4 seconds, depending on the frequency range.

RMS or peak values are shown for each channel in addition to combined sum or maximum values (Figure 25). If these combined values are not needed you can switch to a mode which only shows the channel values in large characters by pressing key ◀ repeatedly (Figure 26).

There will also be an RMS or peak value for channel A if you have connected a sensor to this input. Channel A always measures acceleration. Its frequency range depends on the mode selected for X/Y/Z (Table 3).

If only an uniaxial accelerometer is connected to channel X (sensor cable with 4 pin connector needed) the VM31 displays the results in large numbers (Figure 27).

Mode X/Y/Z	Range X/Y/Z	Range A (acceler.)
Acceleration	0.2 to 1500 Hz	0.2 to 1500 Hz
Acceleration	1 to 1000 Hz	3 to 1000 Hz
Velocity	1 to 100 Hz	1 to 250 Hz
Velocity	2 to 1000 Hz	2.5 to 750 Hz
Velocity	10 to 1000 Hz	2.5 to 750 Hz
Displacement	5 to 200 Hz	1 to 250 Hz

Table 3: Frequency ranges of channels X/YZ A

Vibration velocity is computed by single integration of the acceleration signal, displacement by double integration. Due to integration there is a strong attenuation at high frequencies which limits the measurable frequencies, particularly for displacement. Low frequencies, including noise, are strongly amplified. High pass filtering is inevitable. The frequency response curves of the general vibration ranges can be seen in Figures 28, 29 and 30.

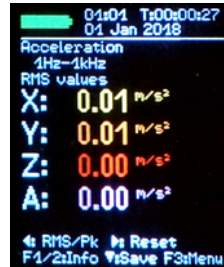

Figure 26: 4 channels in large characters

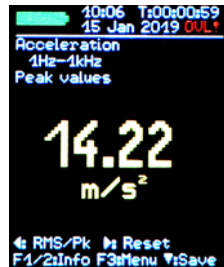

Figure 27: Indication of 1 channel (X)

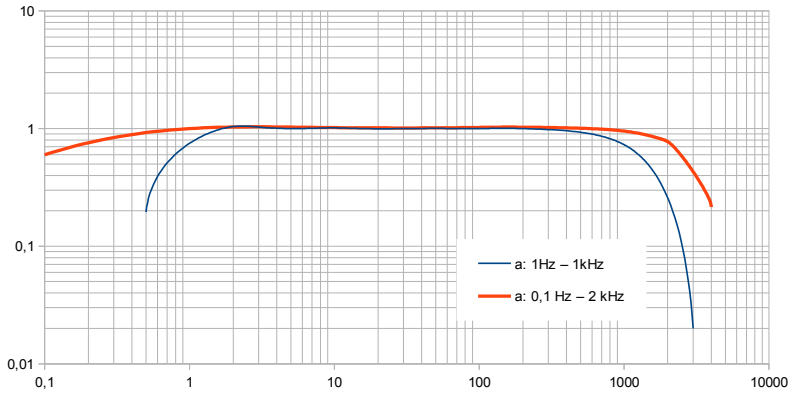

Figure 28: Frequency ranges of vibration acceleration

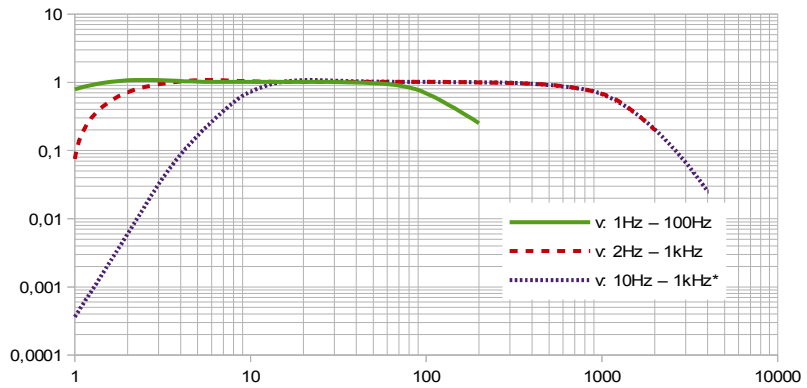

Figure 29: Frequency ranges of vibration velocity

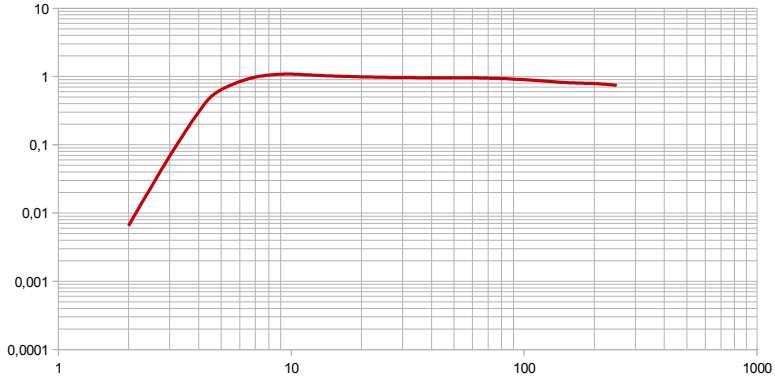

Figure 30: Frequency range of vibration displacement (upper end due to resolution)

Vibration quantity and frequency range can be checked by pressing F1.

Below the 3 (or 4) RMS or peak values you can see two combined values which are calculated from X/Y/Z. These are:

- in RMS mode the vector sum of X/Y/Z ($a_w(\text{Vec})$) and the highest RMS value (Max. abs.) since the last press of the Reset key ►.
- in peak mode the highest of the currently displayed XYZ peak values (Max. XYZ) and the highest peak value (Max. abs.) since the last Reset ►.

Maximum values are displayed in the color of the channel where they occurred.

Pressing the Reset key ►

- deletes the maximum values and
- restarts the measuring timer.

Measurements can be saved by pressing the key ▼ (see page 18).

The Excel file vm31.xlsm can be used to transfer the measurements to a PC.

6. Data Logger

The VM31 can automatically record measuring data for channels X/Y/Z at the speed of the display refresh rate. It can log running RMS or peak values. Logging can be useful in combination with human vibration measurement to detect single vibration or shock events during a longer measuring period. For example, the log file can help to identify shocks caused by putting down a machine tool. Such single events can significantly change the interval RMS value without being relevant in terms of health risks.

The instrument stores data and time along with the three values of X/Y/Z. The recorded measurements

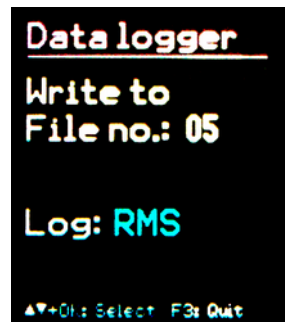

Figure 31: Starting the data logger

are filtered with the same weighting or band filter used for the displayed measurements. Channel A is not recorded.

Please note that the logged data is calculated only for the last display interval (approx. 1 s). For human vibration, however, interval RMS values are measured which are integrated over the entire measuring time. Thus there will be differences between the displayed and the recorded values.

To start the data logger press F3 to open the main menu, select “Data memory” / “Data logger” / “Start logging” (Figure 31). You will be prompted to select a file number. This number will be used later on to identify the log file. The memory can hold 100 log files. File numbers can be 00 to 99. If the selected file should already contain data you will be asked to delete it. Now you select whether RMS or peak values are to be logged. Press OK to leave the menu and to start logging. After a settling time the unit will start to record measurements. The active log mode is indicated in the upper right display corner by the text “LOG!” (Figure 32).

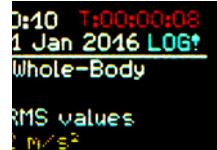

Figure 32: Log indication

Logging can be stopped by pressing F3.

Please note that the data logger will be halted while data is transferred via the USB interface. This may result in missing records.

The automatic shut-off function (see chapter 10.3) is not in use while logging.

The maximum number of records per log file is 32,000 which is sufficient for about 10 hours of continuous recording.

7. Frequency Analysis

The VM31 provides a simple FFT function for the detection of main frequencies. It displays a 125 line peak spectrum of acceleration.

Press F3 and select “Frequency analysis” to open the FFT screen (Figure 33). You see the frequency components of channels X/Y/Z² in their respective channel colors.

The line above the diagram shows frequency and magnitude of the longest spectral line.

The keys ◀▶ move the cursor. Below the diagram you can see the cursor readout.

Press F1 or F2 to change the frequency range. Four ranges are selectable:

- 3 to 244 Hz
- 7 to 488 Hz
- 15 to 977 Hz
- 30 to 1954 Hz

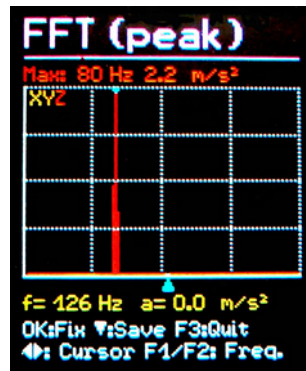

Figure 33: Frequency analysis

By the OK key you can switch between automatic and fixed amplitude scaling. In the help line you see the function of the OK key when you press it next time. In most cases automatic scaling will be the best choice.

Pressing the key ▼ saves the spectrum. The VM31 memory can hold up to 1000 FFTs (see also chapter 8.3).

2 There is no FFT function for channel A.

8. Data Memory

8.1. Measurement Data Memory

The VM31 memory can hold up to 10,000 data records. A record includes:

- Date and time
- Comment (20 characters)
- Filter and measuring mode
- Measuring values X/Y/Z and, if available, channel A and 2 combined values (vector sum and maximum value)

Saved data can be viewed on the screen. Press F3 and select “Data memory” / “View/delete measurement”. Use the keys ▲▼ to navigate through the records (Figure 34).

Single records can be erased by pressing ◀. Erasing means the record is not displayed anymore. Its memory position, however, will not be released until the entire memory is erased. This can be done in the menu “Data memory” / “Delete memory”. Please note that the FFT records will also be erased.

Stored measurement data can be transferred to a PC using the Excel macro file vm31.xlsm.

8.2. Logger Data Memory

To view stored logger data press F3 to open the menu and select “Data memory” / “Data logger”. In this menu open “View logger data”. Use the ▲▼ keys to select the log file to be opened. The menu shows date and time of start, the used recording mode (RMS or Peak), the measuring mode and the filter settings. Press OK to open a selected file (Figure 35).

A file can be deleted by pressing F1.

After opening a log file you can view the contained measurements (Figure Fehler: Verweis nicht gefunden). Use the ▲▼ keys to select a record. The menu shows the record number and the total number of records, date and time of recording and the measuring values X/Y/Z.

Stored logger data can be transferred to a PC using the Excel macro file vm31.xlsm. The file also provides a graphical output.



Figure 34: Data memory

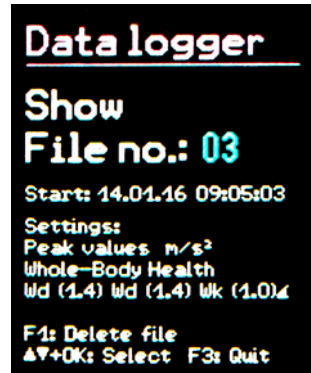

Figure 35: View log files

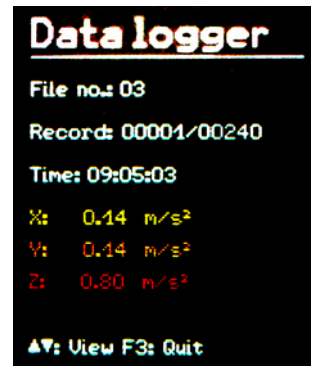

Figure 36: View logger data

8.3. FFT Data Memory

To view stored FFTs press F3 to open the menu and select “Data memory” / “View/delete FFT data”. Use the keys \blacktriangle \blacktriangledown to select the desired FFT. A cursor function using the keys \blacktriangleleft \blacktriangleright is also available (Figure 37).

Stored FFT data can be transferred to a PC using the Excel macro file vm31.xlsm. The file also provides a graphical output.

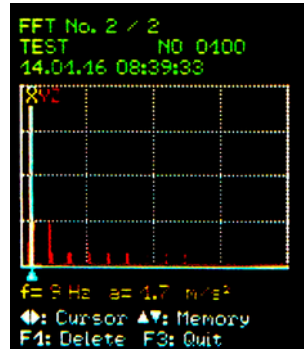

Figure 37: FFT memory

9. Keypad Lock

To prevent manipulation during ongoing measurement, it can be advantageous to activate the key lock. This function can be found in the main menu under “Key lock”

To release the key lock press all four arrow keys \blacktriangleleft \blacktriangle \blacktriangledown \blacktriangleright simultaneously, until the device displays “unlocked”.

10. Device Settings

10.1. Sensor Calibration

If a connected sensor is not TEDS compatible, the VM31 will automatically open the menu “Transducer calibration” (see section 4.2). It can also be opened from the menu “Device settings” to check or to change the entered sensitivities.

Sensitivities are entered one after another for channels X/Y/Z and, if connected, for channel A. The sensitivity value is a five-digit number with the measuring unit mV/ms^{-2} . You find the correct values in the transducer calibration sheet. The decimal point can be shifted by pressing F1. The allowed sensitivity range is 0.800 to 12.000 mV/ms^{-2} or 8.00 to 120.00 mV/ms^{-2} .

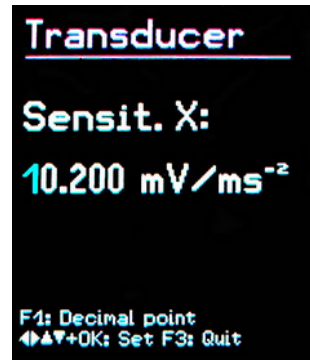

Figure 38: Sensitivity

10.2. Time and Date

When saving measurement values the date and time need to be correctly recorded. To set the date and time, open the main menu by pressing F3 and select “Device settings”. Within this sub menu select “Date and time”. Using keys \blacktriangle \blacktriangledown you can adjust the chosen value. Upon reaching the maximum value, e.g. in the 23rd hour, the counter starts again from the beginning. Press \blacktriangleleft \blacktriangleright to skip between hour, minute, month, day and year. The date takes account of the leap year. It is, however, important to ensure that no invalid day-month combinations are entered.



Figure 39: Time and date

Additionally, clock inaccuracy can be corrected. This can be done using the setting at “Cal.” in ppm (parts per million). The clock frequency can be increased with positive values and decreased with negative. The sign changes to minus at +254 ppm.

10.3. Shut-off Timer

The VM31 has a shut-off timer to help prolong the battery operating life. To set the shut-off timer, open the main menu by pressing F3, select “Device settings” and “Shut-off timer”. Press keys ▼▲ to select the timer duration from the options 1, 5, 15 and 60 minutes. To deactivate the timer select (‘none’). The switch off timer starts to run after the last press of a button. If a button is pressed the timer will restart the count down for the set duration.

10.4. Battery Type

While non-rechargeable batteries have a cell voltage of approx. 1.5 V, NiMH rechargeable batteries deliver around 1.2 V per cell. The discharge curves are also different. The VM31 battery indicator can be adjusted to both types. To select the battery, open the main menu by pressing F3, select “Device settings” and “Battery type”.

Within the sub-menu select “Battery type” (Figure 41) pressing ▼ selects between “Alkaline” (non-rechargeable, 1.5 V) or “NiMH” (rechargeable, 1.2 V).

If the battery power drops below 10 % the battery indicator becomes red. Further measurements can be taken until the power supply reaches 3 V in keeping with the device specifications. At this point the battery level indicator is completely empty and the device switches itself off automatically.

10.5. Display Brightness

In the menu “Device settings”/ “Display brightness”, press the keys ◀▶ to adjust the display settings according to your working environment. The main purpose of reducing display brightness is to save battery power. Current consumption increases by approximately 20 % between the minimum and maximum setting. The difference can be even higher, depending on the display content.

10.6. Menu Language

Open the menu “Device settings” / “Menu language” to change the display language. The available languages depend on the firmware installed.

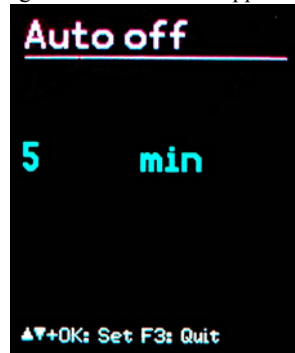

Figure 40: Shut-off timer

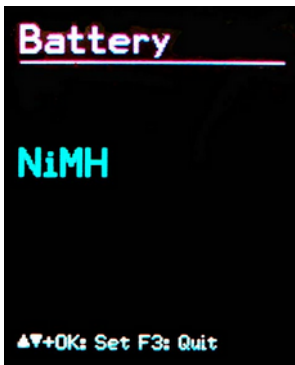

Figure 41: Battery type



Figure 42: Brightness

10.7. Default Settings

If you would like to reset your VM31 to factory settings, open the menu “Device settings” / “Load defaults” . This will also delete the memory but will not alter the transducer sensitivities.

11. Reset Key

If it occurs that the VM31 does not respond to the press of any key, press the reset key to restart the device. The reset key is reached with a thin object through the aperture next to the type label (Figure 44).

Saved data and settings are not lost when the device is reset.



Figure 44: Reset button

12. Connection to a PC

The VM31 has a USB interface. The VM2x-USB cable (Figure 45) is connected to the VM31 via its 8 pin connector. Switch the device off before connecting it to the PC.



Figure 45: USB cable VM2x-USB

Connect the other end of the cable to a USB port on the computer and switch the VM31 on again. If the device is being connected with a particular computer for the first time, a driver installation will be necessary. The driver MMF_VCP.zip can be found on our website: http://mmf.de/software_download.htm

Unpack and save both driver files in a directory on your computer.

When Windows requests details of the source of the device driver, this directory should be entered.

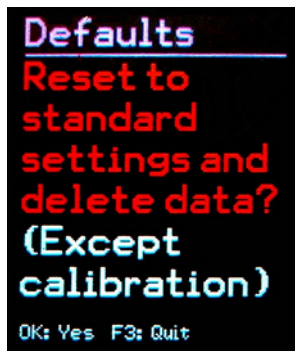

Figure 43: Default settings

The device driver is digitally signed and runs with Windows XP, Vista, 7 and 8.

13. Data Transfer to a PC

13.1. Opening the Excel File vm31.xlsm

The Excel macro file vm31.xlsm is provided to transfer, display and archive data from the VM31. It can be downloaded from http://www.mmf.de/software_download.htm. The file runs with all Excel versions starting from Excel 2007.

It transfers the stored data from the connected VM31 memory into Excel tables. Vibration exposure A(8) or VDV(8) can be calculated from the human vibration records and measuring reports can be generated. FFT data can also be transferred and displayed graphically.

To work with the file you need to allow macro execution. Click the Office button, then “Excel options”, “Trust center”, “Trust center settings” and “Macro settings”. Either choose “Disable all macros with notification” or “Enable all macros”. With the first option you will be asked for permission each time you open the file. With the second option Excel will not ask you for permission again, but there is a potential risk of unwanted or dangerous macro codes being executed from other sources.

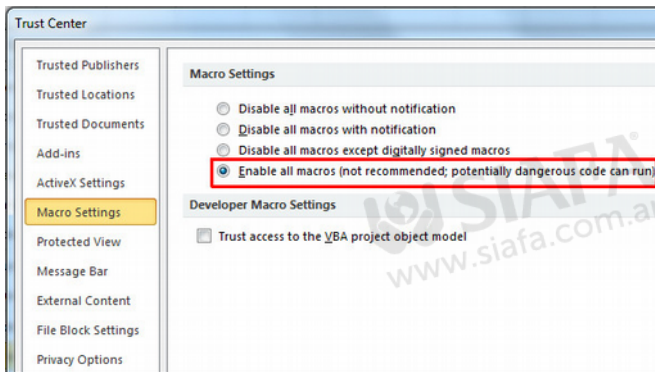

Figure 46: Macro settings in Excel 2010

13.2. Data Import to Excel

Open the worksheet “Import”. If previous measurement data appears in the table, please save the file under another name and then click “Clear tables” to erase all measurements from the tables. Connect the VM31 to a USB port on the PC and switch it on. If not done before, install the device driver (section 12). Click “Import measurements from VM31”. The device with its virtual COM port will be automatically detected. In rare cases detection may fail, due to other connected USB hardware using virtual COM ports. It may be necessary to disconnect such hardware before data transfer.

The messages in the “Status” field inform you about import progress. Data import may take between a few seconds and some minutes depending on the amount of data. When the transfer is completed Excel will automatically sort the data into the following worksheet columns: record number, date, time, comment, mode, filter and the measurements of X/Y/Z and A. Columns B and C contain the combined values.

Sel.	No.	Date	Time	Comment	Mode	Detection	Filter (weighting factor)	Weighting	X	Y	Z	A	B	C	Unit
<input type="checkbox"/>	00001	07.09.14	10:09:36	STAPLER HALLE SCHMIDT	W/B	IRMS	Wg (1.40) Wd (1.40) Wk (1.00)	health	0.91	0.20	1.20	1.70	1.90	1.90	m/s²
<input type="checkbox"/>	00002	07.09.14	12:19:51	STAPLER HOF SCHMIDT	W/B	IRMS	Wg (1.40) Wd (1.40) Wk (1.00)	health	0.24	0.30	1.10	0.70	4.70	4.70	m/s²
<input type="checkbox"/>	00003	07.09.14	12:30:01	STAPLER HALLE MEIER	W/B	IRMS	Wg (1.00) Wd (1.00) Wk (1.00)	health	0.60	0.30	1.70	1.70	2.00	2.00	m/s²
<input type="checkbox"/>	00004	07.09.14	13:10:11	STAPLER HOF MEIER	W/B	IRMS	Wg (1.00) Wd (1.00) Wk (1.00)	health	0.24	1.00	0.80	0.90	3.90	3.90	m/s²

Figure 47: Excel import

13.3. Calculation of Vibration Exposure A(8) and VDV(8)

Vibration exposure A(8), and alternatively, VDV(8), are both used for the risk assessment of human vibration. They can be calculated based on hand-arm (H/A) and whole-body measurements (W/B). Use the check boxes in the left column of the import worksheet to select the data to be included in the vibration exposure calculation. Alternatively, you may click “Select all”. After selecting the data, click the button “Transfer selected data to daily exposure worksheets”. This will transfer the relevant records to the worksheets. These worksheets are available for RMS based hand-arm and whole-body measurements and VDV based whole-body measurements.

A message box will show you how many records have been transferred.

Select and open a worksheet according to the type of calculation you require “A(8) RMS H-A”, “A(8) RMS W-B” or “Daily VDV W-B”.

Vibration exposure can be calculated for several persons and activities, i.e. partial exposures. For this purpose there are two drop down menus for each record. The ten cells “Person” and “Activity” above the table may be overwritten with your own text. The changes you have made will be shown in the drop down menus the next time you transfer data.

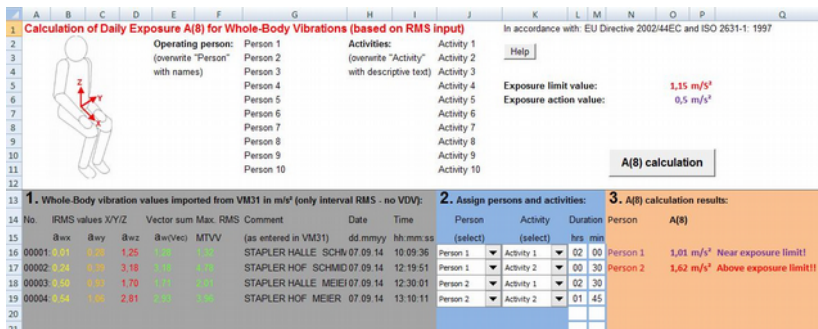

Figure 48: Daily exposure calculation in Excel

Click “A(8) calculation” or, in the case of VDV, “Daily exposure calculation” to calculate the vibration exposure (Figure 48). The result(s) will be compared with the limits stated in the EU directive 2002/44/EC and are displayed in various colors:

black: below exposure action value

purple: between exposure action value and exposure limit

red: above exposure limit

During vibration exposure calculation a report is generated automatically. You can find it in the worksheet “... Report”. It includes tables with the measured values and the partial exposure values for each person and activity. Below you will find the vibration exposure results for each person (Figure 49).

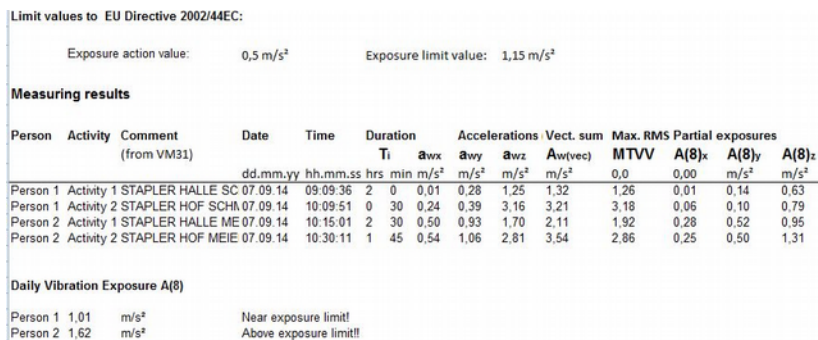

Figure 49: Example report (part)

13.4. FFT Data Import to Excel

The FFT data stored on the VM31 can also be transferred to the Excel macro file. Switch to the worksheet “FFT Import”. If previous FFT data is appears in the table, please save the file under another name and click “Clear FFTs” to clear the table. Then click “Import FFTs from VM31”.

The frequency steps along with the respective amplitudes of X/Y/Z are sorted into table rows. You will see the date, time and comment for each record. Tick the check boxes on the left hand side of each record to select which FFTs should be displayed in the three diagrams above the table (Figure 50).

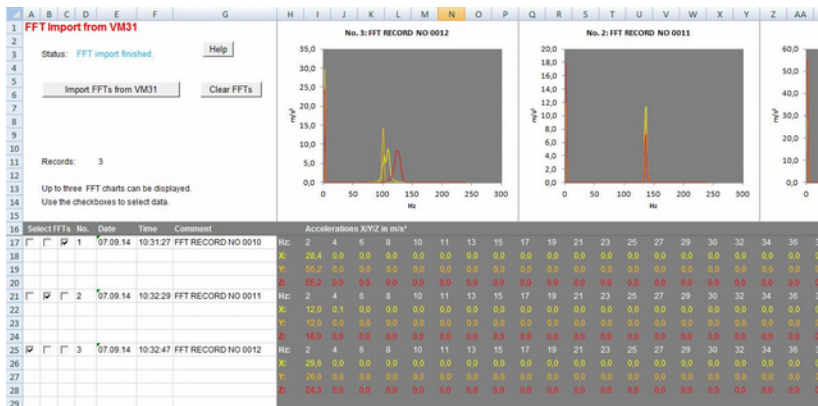

Figure 50: FFT Import to Excel

14. Firmware Update

The device software (Firmware) can be updated via the USB port. First of all, check whether a more up-to-date version than the one currently installed is available. To view the latest version visit our 'Software Download' site.

http://www.mmf.de/software_download.htm

Here you will see the most recent firmware version available. The version number is composed of three digits for the hardware and three for the software (hh-h.ss). Only the last three digits are relevant for the firmware.



Figure 51:
Firmware version

The version currently installed in your device is displayed on the start screen (Figure 51).

If a Firmware version with a higher number is available on the website, proceed as follows:

1. Download the firmware file vm31.hex from the above named internet address.
2. Also download the program “Firmware Updater” from the above named internet address and install it on your PC.
3. Connect the VM31 to the PC using the USB cable and switch it on so that Windows can detect it as a USB device and assign a COM port.
4. Start the “Firmware Updater”, then select the device type “VM31” and the virtual COM port assigned by the PC. If you are not sure which of the available COM ports is correct, you can check in the Windows system control manager located within the device manager.

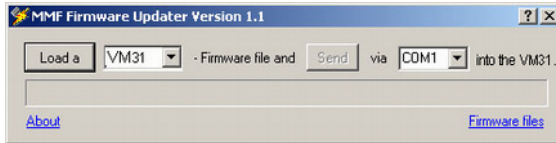

Figure 52: Firmware Updater

5. Click on “Load” in the “Firmware Updater” and enter the path to the file where the downloaded firmware file vm31.hex is located.
6. In the VM31 “Device Settings” select the option “Firmware update” and confirm the warning and subsequent hint messages by pressing OK. By carrying out this step the old firmware is deleted. The VM31 will then indicate that it awaits new firmware data from the USB interface (Figure 53).

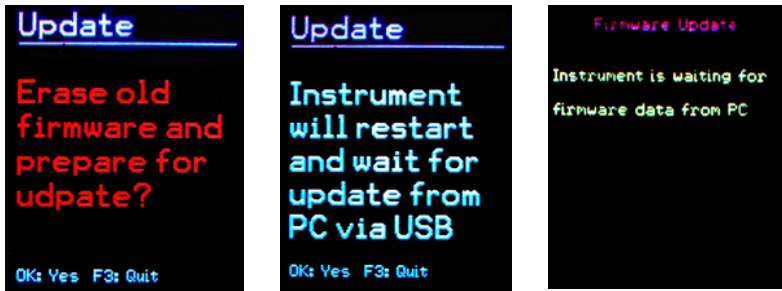

Figure 53: Firmware update

7. Click on “Send” in the “Firmware Updater”. Transfer of the Firmware data has now begun. The transfer progress is displayed as a time bar on the PC and also on the VM31. When the update is finished the VM31 will start up and the “Firmware Updater” will close. Please do not interrupt the update process. Following transfer failures the update can be restarted at point 3.

Important: Before starting an update please ensure that the batteries are sufficiently charged. Otherwise the update may fail and can only be restored by the manufacturer.

15. Calibration

The VM31 is supplied with a factory calibration. In this way it is assured that the instrument measures accurately if a calibrated transducer is connected and its sensitivity entered (see section 10.1). Month and year of the last calibration are shown on the start screen (Figure 51).

The standard ISO 8041 lays down the requirements of electrical and mechanical calibration of human vibration meters.

Figure 54 shows the connections for calibrating the VM31 with electrical signals. The signal generator needs to be connected via the shown R-C combination to the inputs X/Y/Z and A. The 4.7 k Ω resistor serves as a sink for the IEPE constant currents. The 1000 μ F capacitor keeps the resulting DC voltage drop away from the generator. The electrolytic capacitor must be rated for at least 25 V. Please make sure that the generator output can handle the resulting load of approx. 1 k Ω .

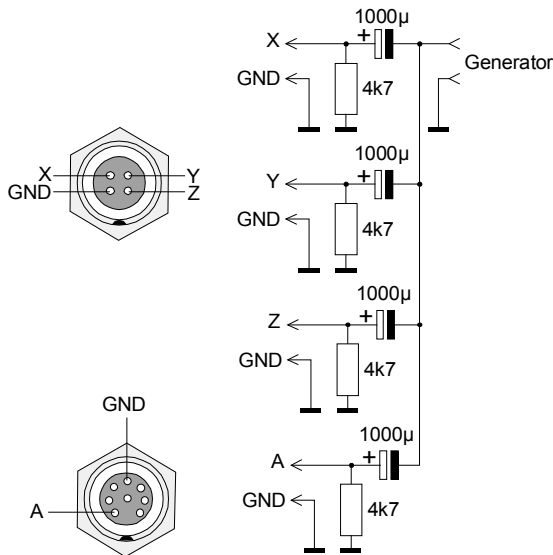

Figure 54: Connections for electrical calibration

Plug for X/Y/Z: *Binder* 711 series, 4 pins, order no. 99-0079-100-04

Plug for A: *Binder* 711 series, 8 pins, order no. 99-0479-100-08

The maximum input voltage without overload indication is ± 1150 mV.

16. Technical Data

Inputs	4 Low-power IEPE inputs, 1 mA / 17 V, transducer sensitivity range 0.8 to 120 mV/ms ² TEDS support for template 25 to IEEE 1451.4	
Display functions	Interval RMS Vector sum	
Human vibration	Maximum running RMS (MTVV) Vibration dose value (VDV) Crest factor (whole body only)	
General vibration (acceleration / velocity / displacement)	Running RMS Maximum running RMS Vector sum Peak value Maximum peak value	
Measuring ranges	Sensor with 1 mV/ms ²	Sensor with 10 mV/ms ²
Acceleration	1100 m/s ²	110 m/s ²
Velocity	100 - 10 000 mm/s (1 kHz/1 Hz)	10 - 1000 mm/s (1 kHz/1 Hz)
Displacement (zero-to-peak values)	250 - 15 000 µm (5 Hz/250 Hz)	25 - 1500 µm (5 Hz/250 Hz)
Display resolution	Sensor with 1 / 10 mV/ms ²	Sensor with 100 mV/ms ²
Acceleration	0.01 m/s ²	0.001 m/s ²
Velocity	0.1 mm/s	0.001 mm/s
Displacement	1 µm	0.1 µm
Linearity range	> 75 dB (for < ± 6 % error)	
Noise	< 0,003 m/s ²	
Filters		
Human vibration	Weighting filters Wb, Wc, Wd, Wh, Wj, Wk, Wm, Wp Unweighted: 6.3 - 1259 Hz (hand-arm); 0.4 - 100 Hz (whole-body)	
Acceleration	0.2 Hz – 1.5 kHz; 1 Hz – 1 kHz	
Velocity	1 Hz – 100 Hz; 2 Hz – 1 kHz; 10 Hz – 1 kHz	
Displacement	5 Hz: – 250 Hz	
Frequency analysis	125 line FFT for X/Y/Z: Peak spectrum of acceleration Frequency ranges: 3 - 240, 6 - 480, 12 - 960, 24 - 1920 Hz Refresh rate: 0,5/s; Windowing: Hann	
Data memory	Flash; 10 000 measurements; 1000 FFTs; 100 log files of 32,000 records each	
Display	OLED, colored, 128×160 pixels	
USB interface	USB 2.0, full-speed, CDC mode, via cable VM2x-USB	
Batteries	3 cells size AAA or Alkaline (LR03) or rechargeable NiMH (HR03)	
Battery oper. time	10 - 14 hours	
Oper. temperature	- 20 – 60 °C	
Dimensions	125 mm x 65 mm x 27 mm (without connectors)	
Weight	140 g (with batteries, without sensor)	

Limited Warranty

Metra warrants for a period of

24 months

that its products will be free from defects in material or workmanship and shall conform to the specifications current at the time of shipment.

The warranty period starts with the date of invoice.

The customer must provide the dated bill of sale as evidence.

The warranty period ends after 24 months.

Repairs do not extend the warranty period.

This limited warranty covers only defects which arise as a result of normal use according to the instruction manual.

Metra's responsibility under this warranty does not apply to any improper or inadequate maintenance or modification and operation outside the product's specifications.

Shipment to Metra will be paid by the customer.

The repaired or replaced product will be sent back at Metra's expense.

Declaration of Conformity

According to EMC Directive 2014/30/EC

Product: Triaxial Vibration Meter

Type: VM31 (from Ser. no. 160000)

It is hereby certified that the above mentioned product complies with the demands pursuant to the following standards:

DIN EN 61326-1: 2013

DIN EN 61010-1: 2011

DIN 45669-1: 2010

The producer is responsible for this declaration

Metra Mess- und Frequenztechnik
in Radebeul e.K.

Meißner Str. 58, D-01445 Radebeul

declared by



Michael Weber

Radebeul, April 22, 2016